

W00448

U.S. Department of Commerce
National Oceanic and Atmospheric Administration
National Ocean Service

DESCRIPTIVE REPORT

Type of Survey: Navigable Area

Registry Number: W00448

LOCALITY

State(s): Maine

General Locality: Maine Coastline

Sub-locality: Vicinity of Sheepscot Bay

2016

CHIEF OF PARTY
Kerby Dobbs, Project Hydrographer

LIBRARY & ARCHIVES

Date:

HYDROGRAPHIC TITLE SHEET

W00448

INSTRUCTIONS: The Hydrographic Sheet should be accompanied by this form, filled in as completely as possible, when the sheet is forwarded to the Office.

State(s): **Maine**

General Locality: **Maine Coastline**

Sub-Locality: **Vicinity of Sheepscot Bay**

Scale: **40000**

Dates of Survey: **04/28/2016 to 10/12/2016**

Instructions Dated: **N/A**

Project Number: **ESD-AHB-18**

Field Unit: **Maine Coastal Mapping Initiative**

Chief of Party: **Kerby Dobbs, Project Hydrographer**

Soundings by: **Kongsberg Maritime EM 2040C (MBES)**

Imagery by: **Kongsberg Maritime EM 2040C (MBES Backscatter)**

Verification by: **Atlantic Hydrographic Branch**

Soundings Acquired in: **meters at Mean Lower Low Water**

Remarks:

The purpose of this survey is to provide contemporary data to update National Oceanic and Atmospheric Administration (NOAA) nautical charts. Any revisions to the Descriptive Report (DR) applied during office processing are shown in red italic text. The DR is maintained as a field unit product, therefore all information and recommendations within this report are considered preliminary unless otherwise noted. The final disposition of surveyed features is represented in the NOAA nautical chart products. All pertinent records for this survey are archived at the National Centers for Environmental Information (NCEI) and can be retrieved via <https://www.ncei.noaa.gov/>.

Products created during office processing were generated in NAD83 UTM 19N, MLLW. All references to other horizontal or vertical datums in this report are applicable to the processed hydrographic data provided by the field unit.

DESCRIPTIVE REPORT MEMO

December 12, 2019

MEMORANDUM FOR: Atlantic Hydrographic Branch

FROM: Report prepared by AHB on behalf of field unit
Kerby Dobbs
Project Hydrographer, Contractor to the Maine Coastal Program

SUBJECT: Submission of Survey W00448

The purpose of this survey was to obtain bathymetric and backscatter data to meet the needs of habitat classification, bathymetric mapping, and sediment resource objectives set forth by BOEM, MCMI, and NOAA. The survey was conducted in part to support the Federal Bureau of Ocean and Energy Management's (BOEM) efforts to enhance coastal resiliency through identification and characterization of potential sand and gravel resources on the outer continental shelf that may be used for beach replenishment.

Products were generated by the hydrographic branch for chart update and archival.

All soundings were reduced to Mean Lower Low Water using Discrete Zoning. The horizontal datum for this project is North American Datum of 1983 (NAD 83). The projection used for this project is Universal Transverse Mercator (UTM) Zone 19.

Survey data were collected in World Geodetic System 1984 (WGS84) with a UTM 19N projection. The project projection was changed at the branch to North American Datum 1983 (NAD83) with a UTM 19N projection. All products were created using NAD83.

A DAPR does not exist for this survey.

All data were reviewed for DTONs and none were identified in this survey.

Maine Coastal Mapping Initiative acquired the data outlined in this report. Data are available at <https://www.maine.gov/dmr/mcp/planning/mcmi/index.htm>

This survey was acquired using QPS QINSy and post-processed in Qimera by the data provider. At AHB, Generic Sensor Format (gsf) files of the processed data were exported from Qimera and a Caris HIPS project was created. From this project, single resolution CUBE surfaces were generated. A sounding set and contours were visually compared with the charted contours from the largest scale Electronic Navigational Charts; where most differences were less than two meters.

The report below was submitted by the field unit detailing their acquisition and processing steps.

This survey does meet charting specifications and is adequate to supersede prior data.



Prepared in cooperation with the Bureau of Ocean Energy Management and National Oceanic and Atmospheric Administration

2016 Descriptive Report of Seafloor Mapping: Mid-coast Maine

By Kerby Dobbs, Project Hydrographer, Contractor to the Maine Coastal Program

Disclaimer

These data and information published herein are accurate to the best of our knowledge. Data synthesis, summaries and related conclusions may be subject to change as additional data are collected and evaluated. While the Maine Coastal Program makes every effort to provide useful and accurate information, investigations are site-specific and (where relevant) results and/or conclusions do not necessarily apply to other regions. The Maine Coastal program does not endorse conclusions based on subsequent use of the data by individuals not under their employment. The Maine Coastal Program disclaims any liability, incurred as a consequence, directly or indirectly, resulting from the use and application of any of the data and reports produced by staff. Any use of trade names is for descriptive purposes only and does not imply endorsement by The State of Maine.

For an overview of the Maine Coastal Mapping Initiative (MCMI) information products, including maps, data, imagery, and reports visit <http://www.maine.gov/dacf/mcp/planning/mcmi/index.htm>.

Acknowledgements

The Maine Coastal Mapping Initiative would like to acknowledge the efforts of the University of Maine sediment laboratory personnel, Hodgdon Vessel Services, Bowdoin College and Maine Maritime Academy interns, and Maine Geological Survey staff for contributing to the success of the 2016 survey season. The individual contributions made by many were an integral part of sampling, analysis, and synthesis of data collected for this project. Funding for this study was provided by provided by the Bureau of Ocean Energy Management (cooperative agreement number M14AC00008) and the National Oceanic and Atmospheric Administration (award numbers NA15NOS4190208 and NA14NOS419006).

Table of Contents

Acknowledgements.....	iii
ABSTRACT.....	1
1.0 Introduction.....	2
2.0 Survey Purpose	2
3.0 Areas Surveyed.....	2
3.1 Mainscheme Survey.....	3
3.2 Inshore Survey	4
3.3 Survey Coverage.....	5
4.0 Data Acquisition	5
4.1 Survey Vessel.....	5
4.2 Acquisition Systems.....	6
4.3 Vessel Configuration Parameters.....	6
4.4 Survey Operations.....	8
4.5 Sound Speed Methods.....	8
4.6 Survey Planning	9
4.7 Calibrations.....	9
4.8 Equipment Effectiveness	10
5.0 Quality Control	10
5.1 Crosslines.....	10
5.2 Junctions	12
6.0 Data Post-processing.....	16
6.1 Horizontal Datum.....	16
6.2 Vertical Datum and Water Level Corrections.....	16
6.3 Processing Workflow.....	18
7.0 Results.....	20
7.1 Final Surfaces.....	20
7.2 Backscatter	20
7.3 Charts and Prior Surveys	23
7.4 Bottom Samples	23
7.5 Seafloor Anomalies.....	23

8.0 Summary	25
References.....	26
Appendix A – Specific dates of data acquisition for mainscheme and inshore surveys	27
Appendix B – Configuration settings for Seapath 330	28
Appendix C – Template database settings in QINSy.....	40
Appendix D – Configuration settings for EM2040C shown in QINSy EM controller.....	54
Appendix E – Mainscheme crossline surface difference test files, results, and plots.....	56
Appendix F – Explanation and details related to vertical offset/inshore post-processing issue	62
Appendix G – Seafloor anomalies	66

Suggested citation:

Dobbs, K.M., 2017. 2016 Descriptive report for seafloor mapping: Mid-coast Maine. Maine Coastal Mapping Initiative, Maine Coastal Program, Augusta, ME. 86 p.

ABSTRACT

During the survey season (April-October) of 2016 the Maine Coastal Mapping Initiative (MCMI) conducted hydrographic surveying using a multibeam echosounder (MBES) in the waters off of mid-coast Maine. The surveying was conducted in part to support the Federal Bureau of Ocean and Energy Management's (BOEM) efforts to enhance coastal resiliency through identification and characterization of potential sand and gravel resources on the outer continental shelf that may be used for beach nourishment. The surveys also coincide with state efforts to update coastal data sets and increase high resolution bathymetric coverage for Maine's coastal waters. A total of approximately 62 mi² (161 km²) of high-resolution multibeam data were collected, 57 mi² (148 km²) in the "mainscheme" area of federal (19 mi²) and state (38 mi²) coastal marine waters, and 5 mi² (13 km²) in nearshore embayments and estuaries. During the 2016 survey season the MCMI also collected sediment samples, water column data, and video in 54 locations, 43 in state water and 11 in federal waters, all within the mainscheme survey area.

The MCMI is currently synthesizing these survey data and existing geophysical (e.g. seismic reflection profiles, side-scan sonar, and vibracores) data collected in the vicinity, which will be used to refine interpretations of coastal/nearshore geomorphology and estimate volumes for potential sand and gravel reservoirs in federal waters.

1.0 Introduction

During the survey season (April-October) of 2016 the Maine Coastal Mapping Initiative (MCMCI) conducted hydrographic surveying using a multibeam echosounder (MBES) in the waters off of mid-coast Maine. The survey was conducted in part to support the Federal Bureau of Ocean and Energy Management's (BOEM) efforts to enhance coastal resiliency through identification and characterization of potential sand and gravel resources on the outer continental shelf that may be used for beach replenishment. The project also coincides with state efforts to update coastal data sets and increase high resolution bathymetric coverage for Maine waters. The project provides new data in the areas covered by National Oceanic and Atmospheric Administration (NOAA) nautical charts (e.g. coastal and harbor) 13286, 13288, 13290, 13293, 13295, and 13296 in mid-coast Maine. These data were not collected or processed for navigational purposes, but are freely provided to NOAA for any use the agency deems appropriate.

2.0 Survey Purpose

The purpose of these surveys was to obtain bathymetric and backscatter data to meet the needs of habitat classification, bathymetric mapping, and sediment resource objectives set forth by BOEM, MCMCI, and NOAA.

3.0 Areas Surveyed

The mainscheme and inshore survey areas were located in Maine's mid-coast region in state and federal waters extending to ~8 nm offshore. The approximately 57 mi² (148 km²) mainscheme survey area adjoins the western extent of the mainscheme area mapped by MCMCI in 2015 (Figure 1). The 2015/2016 mainscheme focus area coincides with the Kennebec River paleodelta, and was selected for this project due to the high probability of being able to identify sand resources in this location (Barnhardt et al., 1994; 1998). Approximately 5 mi² (13 km²) of inshore coverage was completed within portions of the Sheepscot River to adjoin with and extend the inshore surveys conducted in Boothbay Harbor, Maine by the MCMCI in 2014 and 2015 (Figure 2).

An additional hydrographic survey was conducted in May of 2016 within the navigable waters of the Saco River between Camp Ellis and the Biddeford/Saco area of southern Maine. This investigation was performed at the request of the Maine Submerged Lands Program on behalf of the Cities of Saco and Biddeford, Maine. The goal of this survey was to help characterize the distribution and nature of submerged debris in the vicinity of a proposed dredging of the federal channel in the Biddeford/Saco portion of the Saco River. This survey also coincides with state efforts to update coastal data sets for Maine's coastal waters and provides new data in the areas covered by National Oceanic and Atmospheric Administration (NOAA) nautical charts (e.g. coastal and harbor) 13286 and 13287 in southern Maine. A full descriptive report for this survey as well a summary report of the findings related to the submerged debris investigation are described in separate reports (see Dobbs, 2016; 2017a).

Specific dates of data acquisition for mainscheme and inshore surveys are listed in Appendix A.

3.1 Mainscheme Survey

The 2016 mainscheme survey (Figure 1) extends approximately 14 nautical miles south-southwest from the western bank of the Sheepscot River near Reid State Park to a point located approximately 8 nautical miles due south of Small Point, and continues to the northwest to the Quahog Bay bell buoy at Lumbo Ledge on the outer limit of Casco Bay. The coverage extends eastward from Lumbo Ledge to Small Point, where coverage continues to the northeast just offshore of the sandy beaches adjacent to the Kennebec River mouth. Mainscheme survey limits are listed in Table 1.

Mainscheme surveying was conducted on a daily basis, weather permitting, between April and October 2016. The extent of each day's coverage was variable and highly dependent on location and the observed sea-state.

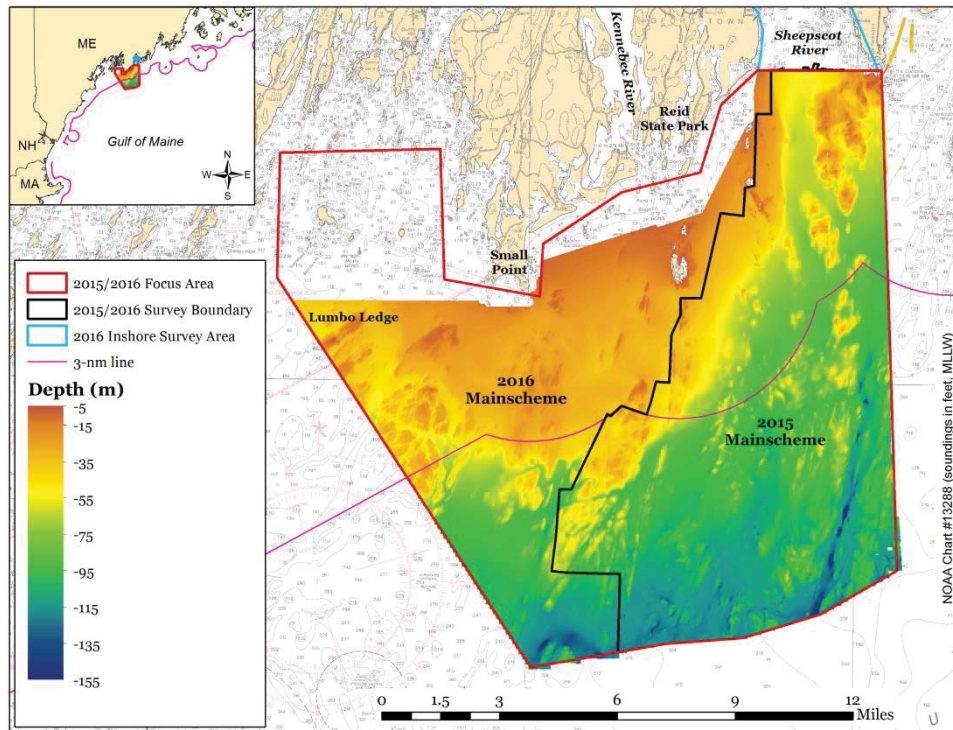

Figure 1. Mainscheme survey coverage within the 2015/2016 focus area (red outline) off of mid-coast Maine. 2016 survey area (57 mi² (148 km²)) is west of black line. 2015 survey area (80 mi² (207 km²)) is east of black line. Survey coverage includes portions of NOAA nautical charts 13286, 13288, 13290, 13293, 13295, and 13296.

Table 1. 2016 mainscheme survey limits

Southwest Limit	Northeast Limit
43° 33.531" N	43° 46.981" N
69° 57.153" W	69° 42.576" W

3.2 Inshore Survey

Inshore surveying was completed within the following portions of the Sheepscot River (light blue outline in Figure 2): Townsend Gut (Southport, ME), Little Sheepscot River (MacMahan Island, ME), Ebenecook Harbor (Southport, ME), and along the Sheepscot River mainstem from Isle of Springs south to Sheepscot Bay. The southern extent of the inshore surveys adjoin the northern extent of the 2015/2016 mainscheme surveys along an east-west line spanning the width of the Sheepscot River between Cape Newagen (to the east) and Griffith Head (to the west). Inshore survey limits are listed in Table 2.

Inshore surveying was conducted on a semi-regular basis between in May and June 2016. The inshore surveying typically occurred when conditions were unsuitable for surveying in the mainscheme area.

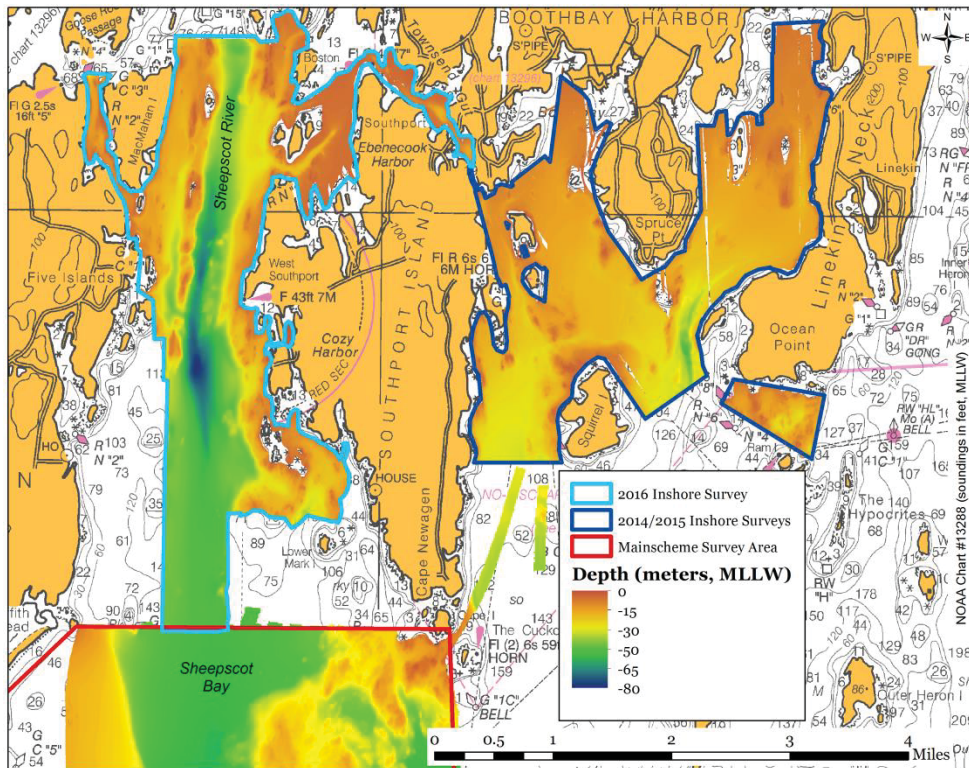

Figure 2. Inshore multibeam coverage within the lower Sheepscot River in mid-coast Maine. 2016 coverage (5 mi² (13 km²) outlined in light blue. 2014/2015 inshore coverage outlined in dark blue. Northern extent of adjacent mainscheme area is outlined in red. Includes portions of NOAA nautical charts 13288, 13293, 13295, and 13296.

Table 2. 2016 inshore survey limits

Southwest Limit	Northeast Limit
43° 46.862" N	43° 51.516" N
69° 43.004" W	69° 39.049" W

3.3 Survey Coverage

Holidays (gaps in MBES coverage) within the surveyed areas were rare, and occasionally appear as sonic shadows caused by areas of locally high relief and/or highly irregular bathymetry adjacent to inshore ledges. Holidays in inshore areas were mainly caused by survey obstructions (e.g. moored vessels, dense fishing gear, exposed ledges, etc.) Overall, it can be assumed with confidence that the shallowest depths of all features within the 2016 survey areas have been identified.

4.0 Data Acquisition

The following sub-sections contain a summary of the systems, software, and general operations used for acquisition and preliminary processing during the 2016 survey season.

4.1 Survey Vessel

All data were collected aboard the Research Vessel (R/V) Amy Gale (length = 10.7 m, width = 3.81 m, draft = 0.93 m) (Figure 3), a former lobster boat converted to a survey vessel, contracted to the MCMI. The vessel was captained by Caleb Hodgdon of Hodgdon Vessel Services based out of Boothbay Harbor, Maine. The multibeam sonar, motion reference unit (MRU), surface sound speed probe, and dual GNSS antennas were pole-mounted (Figure 3) to the bow and were raised (for transit) and lowered (for survey) via a pivot point at the edge of the bow. The main cabin of the vessel served as the data collection center and was outfitted with four display monitors for real time visualization of data during acquisition.



Figure 3. R/V Amy Gale shown with pole-mounted dual GPS antennas, Kongsberg EM2040c multibeam sonar, MRU (not visible), and surface sound speed probe (not visible) in acquisition mode.

4.2 Acquisition Systems

The real time acquisition systems used aboard the R/V Amy Gale during the 2016 survey are outlined in Table 3. Data acquisition was performed using the Quality Positioning Services (QPS) QINSy (Quality Integrated Navigation System; v.8.12) acquisition software. The modules within QINSy integrated all systems and were used for real-time navigation, survey line planning, data time tagging, data logging, and visualization.

Table 3. Summary of acquisition systems used aboard R/V Amy Gale

Sub-system	Components
Multibeam Sonar	Kongsberg EM2040c and processing unit
Position, Attitude, and Heading Sensor	Seapath 330 processing unit, HMI unit, dual GPS/GLONASS antennas, and MRU 5 motion reference unit
Data Acquisition and Display	QINSy software v.8.12 (Build 2016.03.16.2) and 64-bit Windows 7 PC console
Surface Sound Velocity (SV) Probe	AML Micro X with SV Xchange
Sound Velocity Profiler (SVP)	Teledyne Odom Digibar S sound speed profiler
Ground-truthing/Sediment Sampling Platform	Ponar grab sampler, GoPro Hero video camera, dive light, dive lasers, YSI Exo I sonde

4.3 Vessel Configuration Parameters

Prior to the start of the survey season, the acquisition system components (e.g. MRU, GPS antennas, and EM2040C) were measured in reference to the MRU, which served as the origin (e.g. 0,0,0), where ‘x’ was positive forward, ‘y’ was positive starboard, and ‘z’ was positive down. Reference measurements for each component were entered into the Seapath 330 Navigation Engine (Table 4) and converted so all outgoing datagrams would be relative to the location of the EM2040c transducer (e.g. EM2040c was used as the monitoring point for all outgoing datagrams being received by QINSy during acquisition). Additional configuration and interfacing of all systems were established during the creation of a template database in the QINSy console. See appendices for specific settings as entered in the Seapath 330 Navigation Engine (Appendix B) and for the template database (Appendix C) used during data acquisition while online in QINSy. Configuration settings of the EM2040c were assigned in the EM Controller module of QINSy (see Appendix D).

As a result of modifications made to the transducer mounting flange (Figure 4), the reference measurements for 2016 differ slightly from those assigned for 2014 and 2015 surveys. These modifications were prompted during the 2015 survey season by a reoccurring problem with a

loss of datagrams due to EM2040c transducer cable interference, which was caused by frequent agitation of the cable when surveying. The lack of rigidity, support, and protection along the external, pole-mounted cable relays was identified as a design flaw that ultimately needed adjustments prior to the 2016 survey season. As shown in Figure 4, the re-design for 2016 was more streamlined and has two additional support brackets for the transducer cable on the mounting flange. In addition, the MRU was moved from an external mount (as shown for 2014-2015 configuration in Figure 4) on the top of the transducer to an interior mount within the pole mount directly atop the transducer head. The new configuration housed all MRU components internally, thus protecting them from general wear and tear. The SV (sound speed) probe was also relocated and external cabling had negligible exposure to the elements.

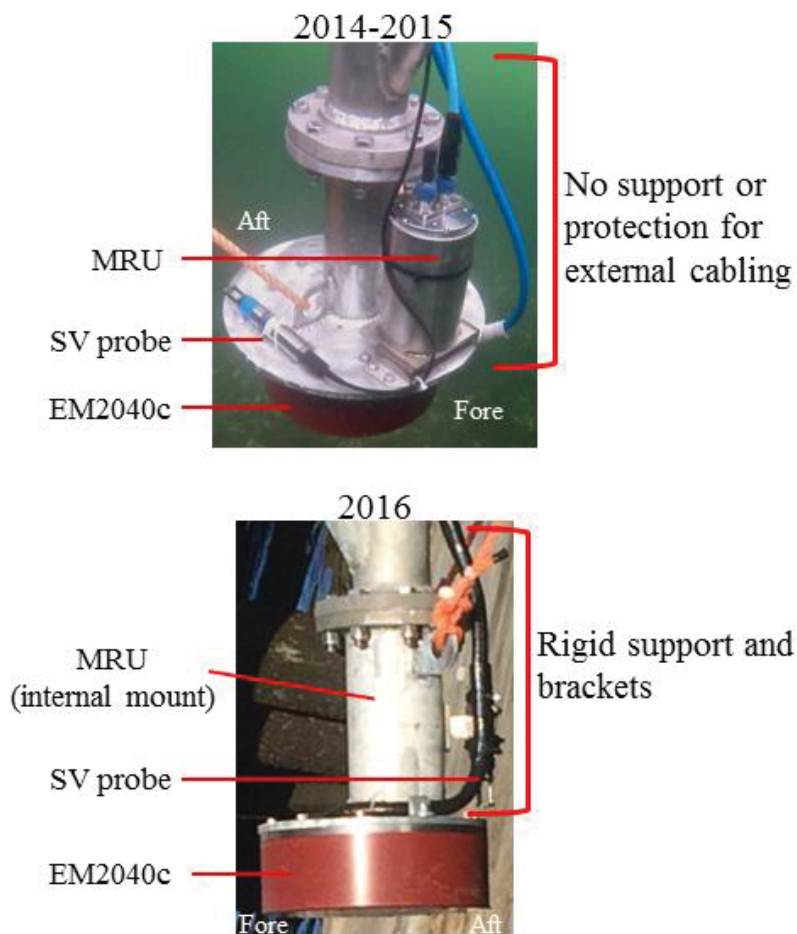

Figure 4. Transducer mounting flange configuration aboard the R/V Amy Gale during the 2014-2015 field seasons vs modifications for 2016 field season. When viewing the 2014-2015 configuration note the lack of support for virtually all cabling along relays from flange to pole mount. 2016 configuration has flush-mounted EM2040c transducer, internally-housed MRU, redundant support for external transducer and SV probe cabling, and more streamlined profile.

Table 4. 2016 equipment reference frame measurements for Seapath 330

	<u>x (m)</u>	<u>y (m)</u>	<u>z (m)</u>
MRU	0.000	0.000	0.00
Antenna 1 (port)	0.155	-1.250	-3.007
Antenna 2 (starboard)	0.155	1.250	-3.007
EM2040C	0.039	0.000	0.132

4.4 Survey Operations

The following is a general summary of daily survey operations. Once the survey destination was reached, the sonar pole mount was lowered into survey position and its bracing rods were fastened securely to the hull of the ship via heavy-duty ratchet straps. Electric power to the computers was provided by a 2000 watt Honda generator. Immediately following power-up, all interfacing instruments were given time to stabilize (e.g. approximately 30-45 minutes for Seapath to acquire time tag for GPS). Next, the desired QINSy project (e.g. mainscheme, inshore, etc.) was selected for data acquisition. All subsequent files (e.g. raw sonar files, sound speed profiles, grid files, etc.) were recorded and stored within their respective project subfolders on a local drive. Prior to surveying, a sound speed cast was taken and imported into the ‘imports’ folder of the current project. After confirming a close match between the upcast and downcast data, the profile was applied to the sonar (EM2040C) in the QINSy Controller module. Raw sonar files were logged in the QINSy Controller module in .db format and saved directly onto the hydrographic workstation computer.

At the end of each day’s survey, sonar and navigation systems were powered down and the pole mount was raised and fastened for transit back to port. Upon arriving at the dock, all external instruments/hardware were visually inspected and rinsed with freshwater to prevent corrosion.

Raw xyz data (e.g. bathymetry and backscatter) were exported and total daily coverage was calculated using the QINSy Process Manager. These data were used to create progress maps and to supplement daily logs, which were submitted to the project manager on a weekly basis. All data were backed up daily on an external hard drive.

4.5 Sound Speed Methods

After the initial application of the day’s first sound speed profile additional sound speed casts were taken as needed throughout the survey, which was generally when the observed surface sound speed differed from the surface sound speed in the active profile by more than 2 meters per second. In certain instances supplemental casts were taken when there was reason to suspect significant changes in the water column (e.g. change in tide, abrupt changes in seafloor relief, etc.). During the collection of sound speed casts, logging was stopped to download and apply the new cast and was resumed when the boat circled around and came back on the survey line. Throughout the duration of the survey, the surface sound speed observed in real-time (by the AML Micro X SV probe) at the transducer head was applied as the first entry in the active sound speed profile. Although sound speed data were recorded in raw sonar files, the raw sound velocity profiles (.csv) were also submitted with the survey data.

A quality comparison between the AML Micro X SV sensor and the Teledyne Odom Digibar S profiler was not performed. However, real-time comparisons between surface sound speed observed by the AML Micro X SV and the surface sound speed entry in the Digibar S profile suggested these instruments were in agreement.

4.6 Survey Planning

Line planning and coverage requirements were designed to meet the specifications set forth in the BOEM grant, but also met requirements for NOAA hydrographic standards (NOAA Field Procedures Manual, 2014). In the mainscheme area, parallel lines were mostly planned in several days prior to surveying and run in a NE-SW or E-W pattern, depending on the location. Lines varied in length from 1 to 3 nautical miles, and were spaced at consistent intervals to obtain a minimum of 10% overlap between full swaths. However, soundings from beam angles outside of ± 60 degrees from the nadir were blocked from visualization during acquisition, thus increasing the true minimum full-swath overlap. This online blocking filter was recommended by Quality Positioning Services field engineers with the intent of eliminating noisy outer beams from the final product, thereby increasing the overall contribution of higher quality soundings. In situations where bottom relief was highly irregular, typically in shallow water (e.g. <40 meters), overlap between swaths was increased considerably and was sometimes as much as 50%. All surveys were conducted at approximately 6 - 6.5 knots, although some inshore surveys required slower speeds to ensure safe operation of the vessel around obstructions (e.g. fishing gear, docks, ledges, etc.).

4.7 Calibrations

One patch test was conducted aboard the R/V Amy Gale at the beginning of the 2016 survey season to correct for alignment offsets and evaluate any adjustments caused by the new configuration described in section 4.3 (Table 5). During the test, a series of lines were run to determine the latency, pitch, roll, and heading offset. The patch test data were processed in the field using the Qimera (v.1.2.0) patch test tool. After calibration was complete, offsets were entered in to the template database in QINSy. Overall, roll and pitch offsets calculated for this patch test were comparable to calibrations from previous seasons. Full built-in self-tests (BIST) were performed at semi-regular intervals throughout the season to determine if any significant deviations in background noise were present at the chosen survey frequency of 300KHz.

Table 5. 2016 patch test calibration offsets for EM2040c

	<u>4/27/2016</u>
Latency (seconds)	0.00
Roll (degrees)	0.19
Pitch (degrees)	0.89
Heading (degrees)	-0.40

4.8 Equipment Effectiveness

Sonar

Sonar data were acquired with a Kongsberg EM2040c set to a survey frequency of 300 kHz, high-density beam forming, with 400 beams per ping. Although the depths of the 2016 surveys allowed full swath widths at this frequency, lines from previous year's survey run at comparable depths contained considerable noise in outer beams ($> \pm 60$ degrees from the nadir; as identified by QPS engineers). As a result (and as per QPS recommendation), these soundings were not included in final bathymetric surfaces.

Motion Latency

Due to concerns about potential motion latency in mid-June 2016, a small sample of sonar data was submitted to NOAA personnel for evaluation. An informal evaluation of the data performed by NOAA identified a motion latency of 0.02 seconds. In certain acquisition software (e.g. SIS), this latency can be applied in real time. QINSy only allows motion latency to be applied in real time to systems with non-UTC drivers and there was not a non-UTC option for our setup. Thus, any latency values would have to be applied during post-processing. However, no latency adjustments were incorporated during post-processing due to negligible improvement when applied to a subsample of survey data.

Hydrographic Workstation and Acquisition Software (QINSy)

On April 28th, 2016 raw sonar file prefix numbers had to be reset twice due to several acquisition software (QINSy) crashes, which forced the hydrographer to create a new survey grid within the project. As a result, multiple raw sonar files collected on this day share the same prefix. Support from QPS was immediately requested via their online ticket system. The issues were resolved during a remote support session with QPS the following morning.

During start up on May 12, 2016, it became apparent that the main hard drive used for MBES data storage had crashed, and as a result rendered the QINSy software inaccessible. However, all survey data had been backed up and no data were lost. A remote support session with QPS revealed the crash had reset the workstation firewall, which was blocking several QPS and Kongsberg software drivers. QPS support resolved the issue and surveying was resumed on May 18, 2016. As a result of the crash, multiple raw sonar files collected on May 18th, 2016 share the same prefix as sonar files collected in the mainscheme area prior to this date.

Following the instances described above, the hydrographic workstation and QINSy software remained stable for the duration of the survey season.

5.0 Quality Control

5.1 Crosslines

Crosslines were run every 900 meters (as per BOEM requirement; U.S. Department of the Interior, 2014) to act as a data quality check (Figure 5). Crosslines were filtered during post-processing to remove soundings greater than 45 degrees from the nadir. After filtering, the two-dimensional surface area of the crossline surface accounted for approximately 8% of the mainscheme area. Crossline sounding agreement with mainscheme data was evaluated by using

the cross check tool in Qimera v.1.3.6. The mean difference between these surfaces was 0.03 meters with a standard deviation of 0.25 meters. Summary statistics for this analysis are shown in Table 6. The reference surface and crossline files, as well as plots generated from this analysis are reported in Appendix E. Raw difference data, reference surfaces, and sonar files used for this analysis were submitted with the data in these surveys.

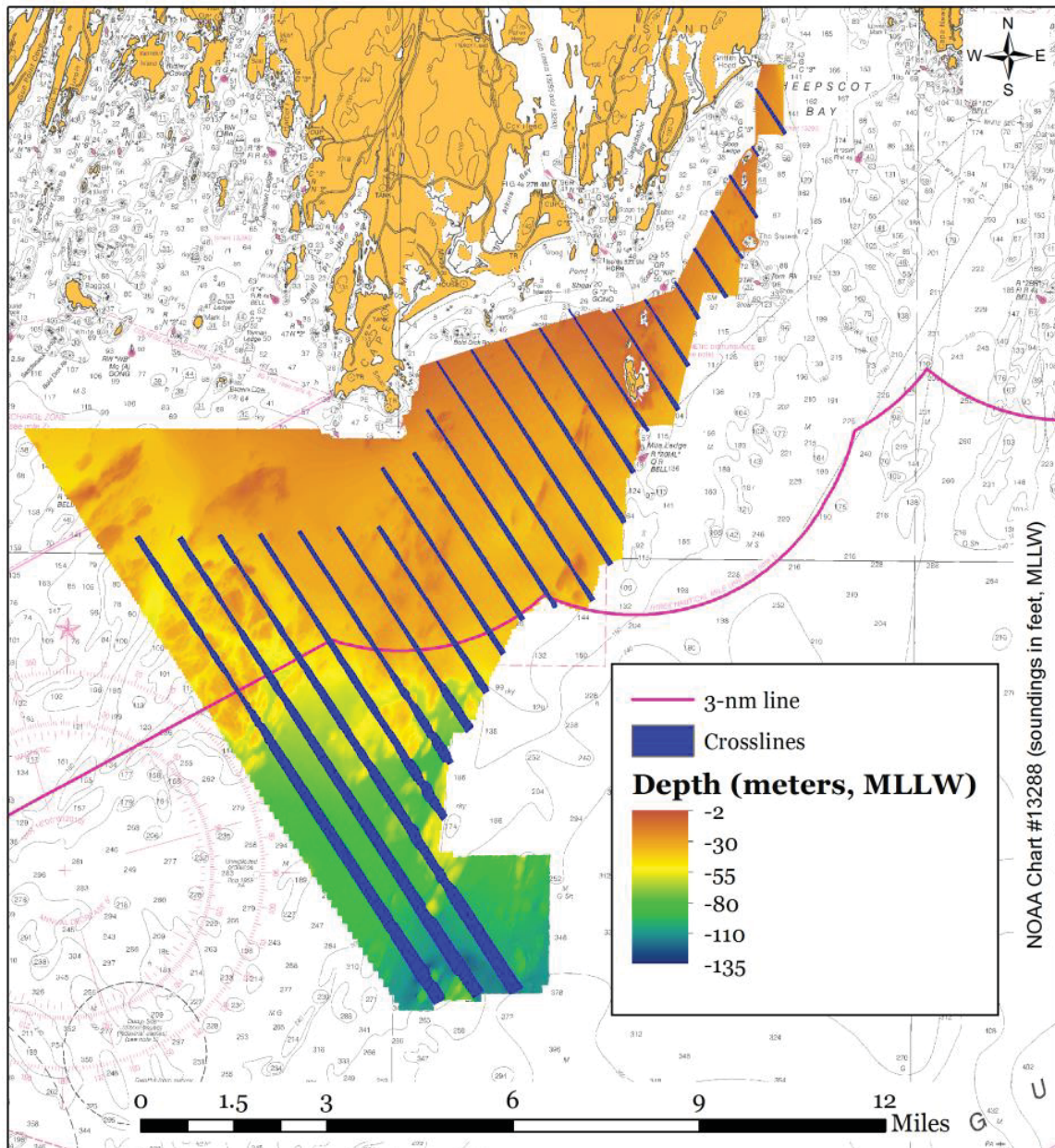

Figure 5. 2016 mainscheme crossline coverage (full-swath, blue) relative to mainscheme coverage.

Table 6. Mainscheme cross check summary statistics

# of Points of Comparison	48899424
Data Mean	-34.288084
Reference Mean	-34.254108
Mean	0.033976
Median	0.338406
Std. Deviation	0.253795
Data Z - Range	-135.83 to -3.59
Ref. Z - Range	-158.06 to -2.02
Diff Z - Range	-22.80 to 23.48
Mean + 2*stddev	0.541566
Median + 2*stddev	0.845996
Ord 1 Error Limit	0.500692
Ord 1 P-Statistic	0.029038
Ord 1 - # Rejected	1419919
Order 1 Survey	ACCEPTED

*Order 1 parameters: a = 0.25 and b = 0.013

5.2 Junctions

The areas of overlap between 2015 and 2016 mainscheme and inshore surveys were evaluated for sounding agreement by performing surface difference tests in Fledermaus (v.7.7.0), where the 2015 base surface was subtracted from the corresponding 2016 junction surface. A summary of three surface difference tests is shown in Table 7. The extent of overlap between the 2015 base surface and the corresponding 2016 junction surface for each test is illustrated in Figures 6 and 7. The .BAG surfaces used for these tests are submitted with the data in these surveys.

Table 7. Summary of surface difference test results for overlapping (junction) surveys

Junction Surface ID	Base Surface ID	Median (m)	Mean (m)	Std. Dev. (m)
MCMI_mainscheme_2016_4m_MLLW	MCMI_mainscheme_2015_4m	0.02	0.07	0.82
MCMI_inshore_2016_4m_MLLW	MCMI_mainscheme_2015_4m	0.06	0.08	0.27
MCMI_inshore_2016_1m_MLLW	MCMI_inshore_2015_50cm	0.03	0.07	0.26

Results were obtained by subtracting 2015 surface from 2016 surface.

Several factors were thought to contribute to the high standard deviation in the overlapping mainscheme surveys: poor agreement in rocky areas, filtering procedures, and slight differences in time and range corrections. As illustrated in Figure 6, the most disagreement between surfaces was in areas with a steep, rocky seabed. In addition, the 2015 data included soundings

from all beam angles (± 65 degrees from the nadir), whereas the 2016 data were filtered to exclude soundings from beams $> \pm 60$ degrees from the nadir. Although the 2015 data were not revisited for this analysis, it is possible that poor quality data from the outermost beams (where applicable) caused greater disagreement in certain areas. Furthermore, the 2015 mainscheme data were corrected by applying a wholesale time and range correction (e.g. -6 mins *0.95; see zone NA150 in Figure 8 and Table 8) to reference station (Portland 8418150) tide data, whereas 2016 mainscheme data were corrected using time and range corrections assigned in four discrete zones (see section 5.2 – Vertical Datum and Water Level Corrections). Although these zones had the same time corrections and the same or similar range corrections, it is possible these may have a small contribution to the vertical error observed in overlapping surfaces.

Overall, agreement was the best in overlapping areas with a smooth and/or flat seafloor. Likewise, standard deviations for the inshore areas were highest in areas with rocky and/or irregular seabed features.

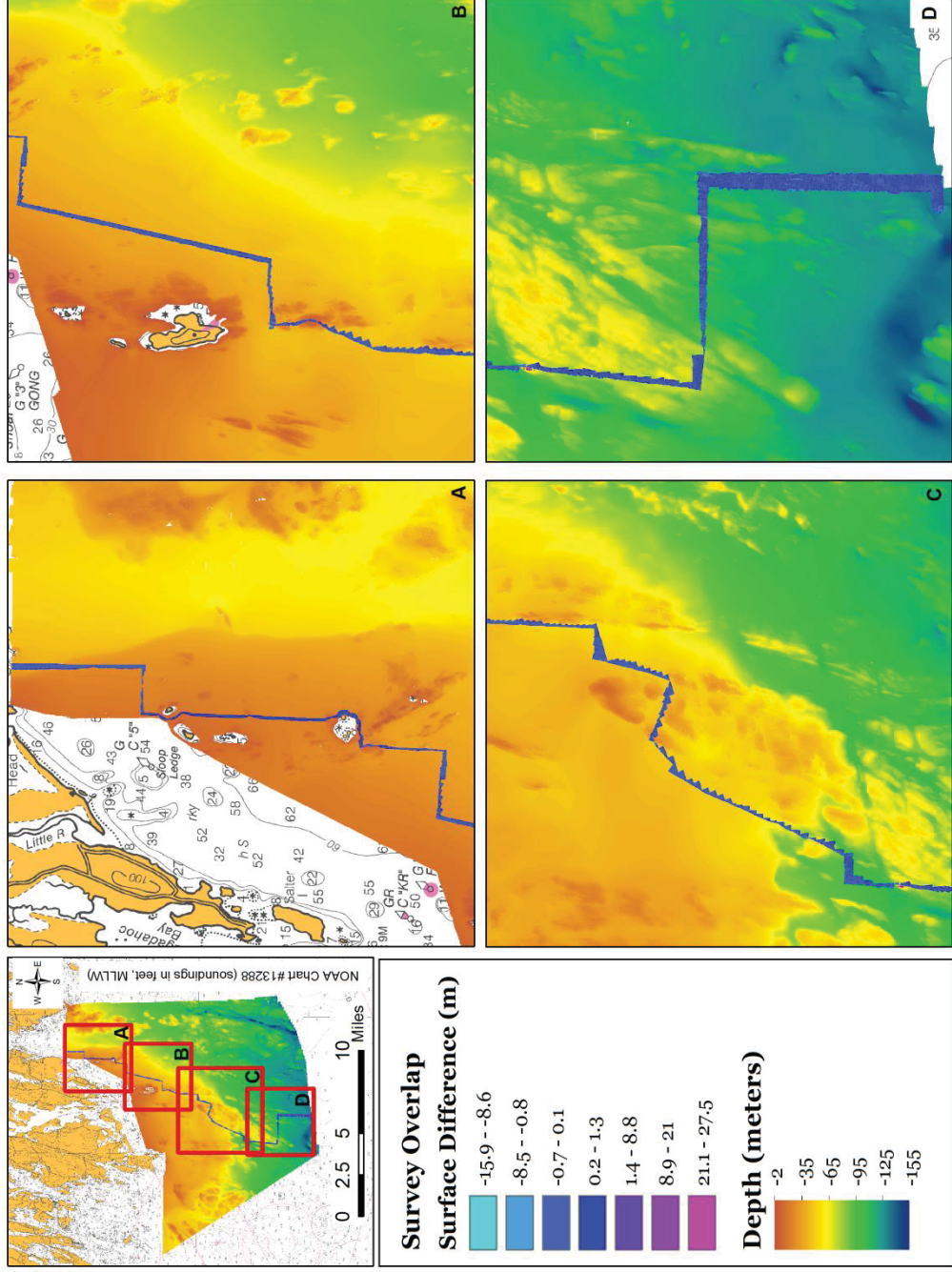

Figure 6. Extent of overlap and surface difference between 2015 and 2016 mainscheme surveys (4-meter surfaces).

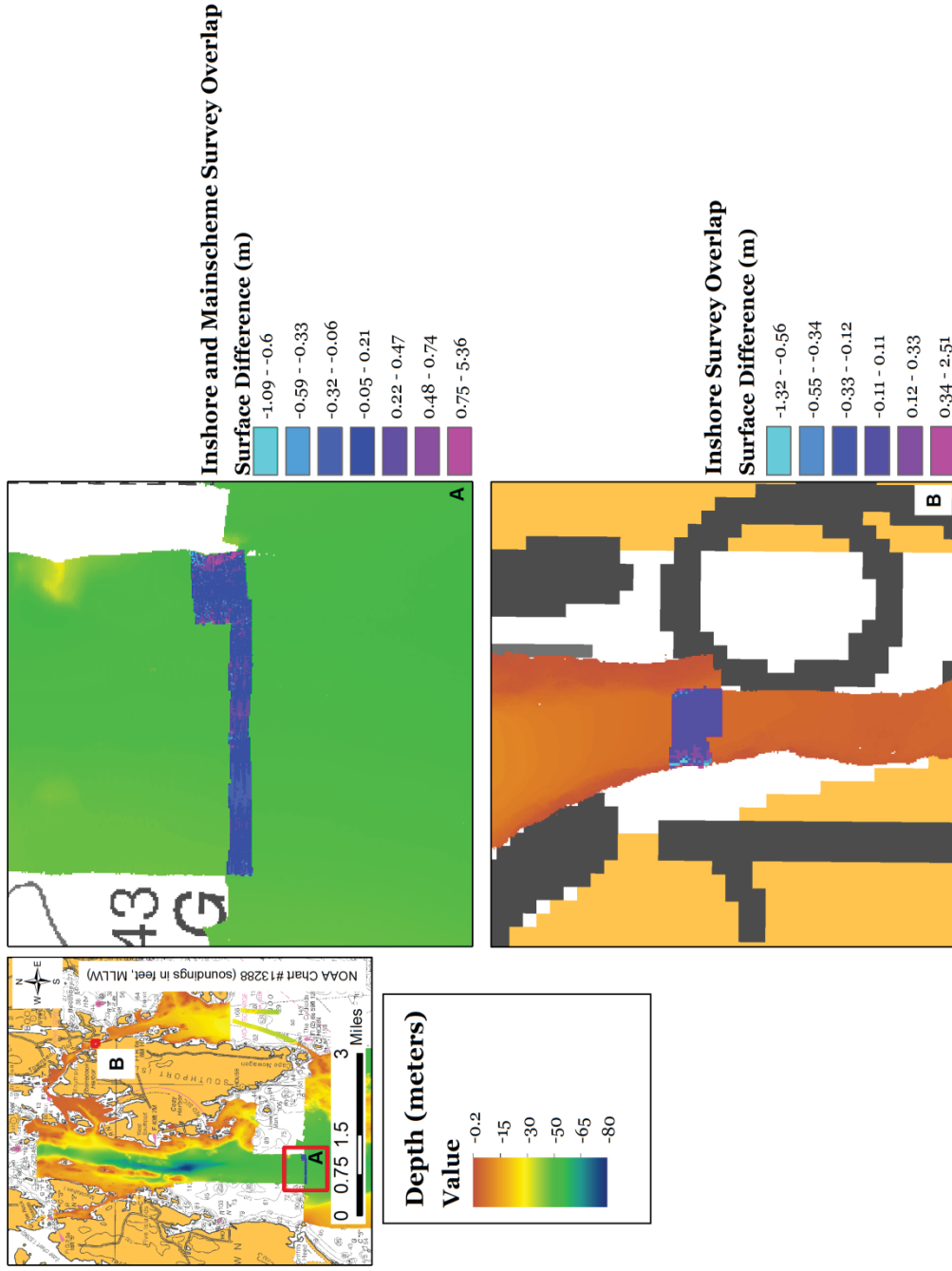

Figure 7. Extent of overlap and surface differences between (a) 2016 inshore and 2015 mainscheme surveys (4-meter surfaces) and (b) 2016 inshore (1-meter surface) and 2015 inshore (0.5-meter surface) surveys.

6.0 Data Post-processing

The following is a summary of the procedures used for post-processing and analysis of survey data using Qimera (v.1.3.6) and Fledermaus (v.7.7.0) software.

6.1 Horizontal Datum

The horizontal datum for these data is WGS 84 projected in UTM zone 19N (meters).

6.2 Vertical Datum and Water Level Corrections

The vertical datum for these data is mean lower-low water (MLLW) level in meters. A tidal zoning file (.zdf; provided by NOAA CO-OPS) containing time and range corrections for verified data referenced from the Portland, ME (8418150) tide gauge was applied to all areas surveyed (Figures 8 and 9). Time corrections, tide height offsets, and tide scale (range) for each zone are listed in Table 8.

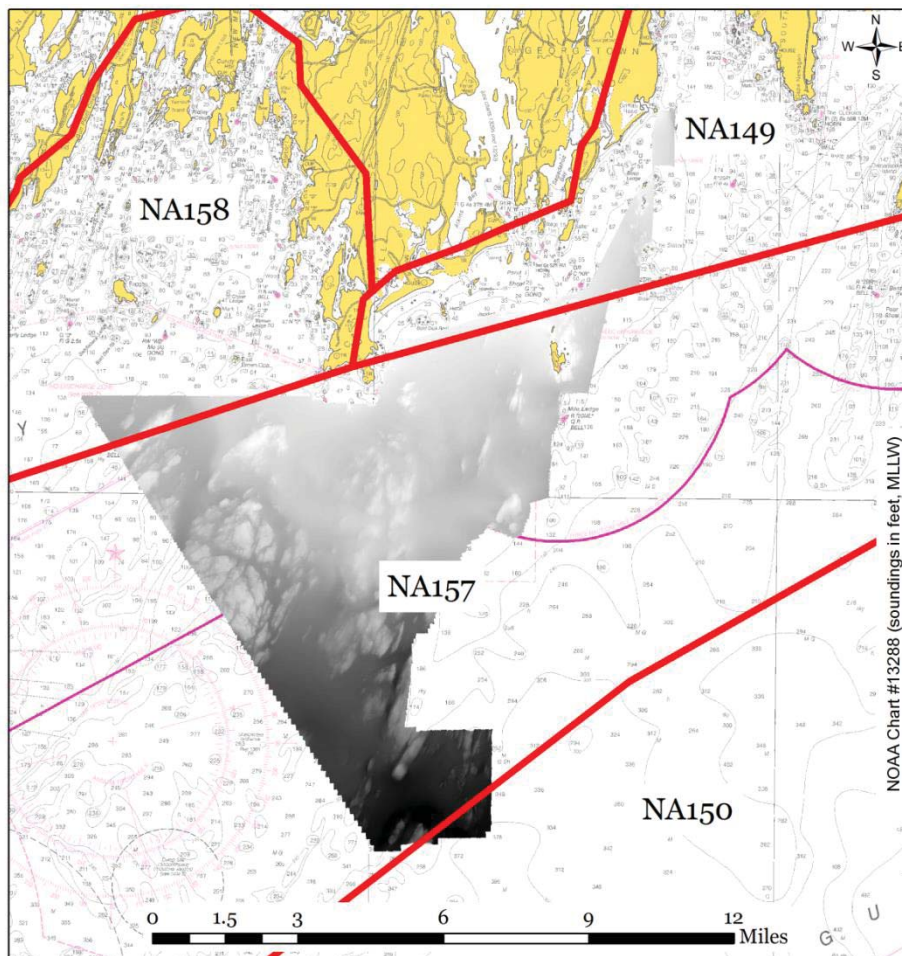

Figure 8. Tide zones (outlined in red) relative to mainscheme survey coverage.

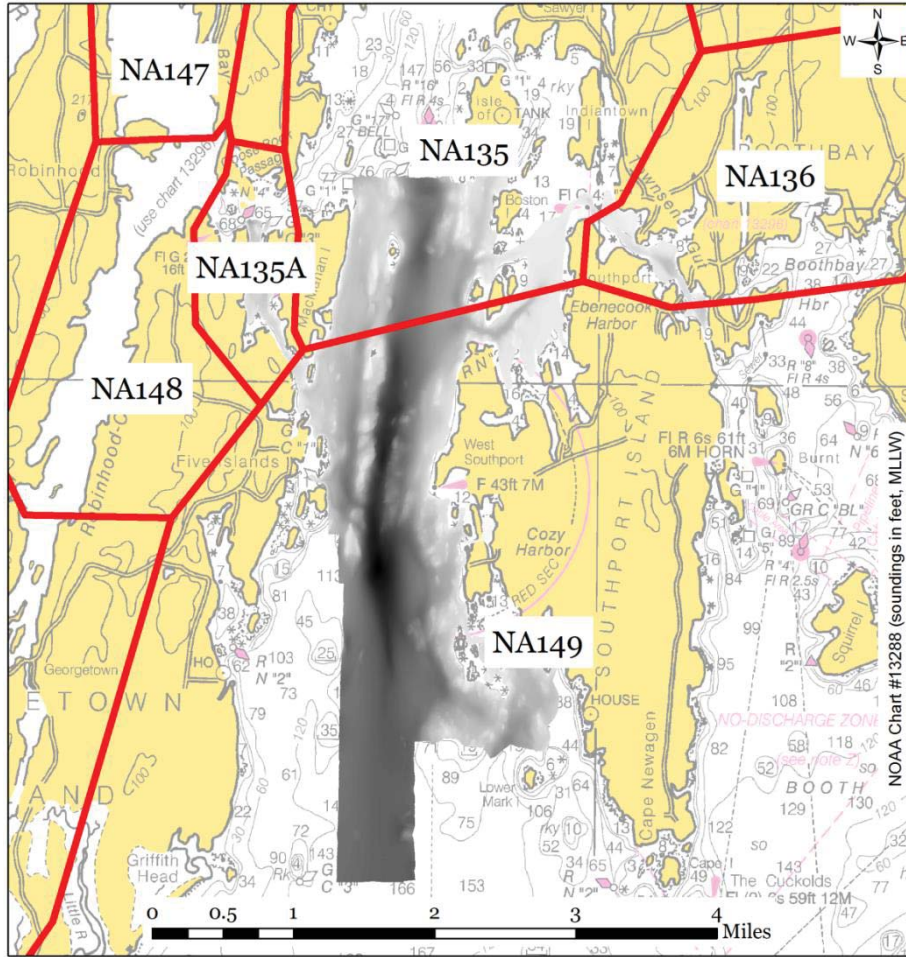

Figure 9. Tide zones (outlined in red) relative to inshore survey coverage. Zones NA147 and NA148 were not included in surveyed area.

Table 8. Tide zones and corrections referenced to verified Portland (8418150) tide data

Zone ID	Time Correction (mins.)	Tide Offset (m)	Tide Scale	Survey Area
NA135	0	0	0.98	Inshore
NA135A	6	0	0.96	Inshore
NA136	-6	0	0.98	Inshore
NA147	18	0	0.96	-
NA148	12	0	0.96	-
NA149	-6	0	0.96	Inshore/Mainscheme
NA150	-6	0	0.95	Mainscheme
NA157	-6	0	0.95	Mainscheme
NA158	-6	0	0.97	Mainscheme

6.3 Processing Workflow

Two projects, mainscheme and inshore, were created in Qimera for post-processing. The general work flow was as follows:

1. Create project
2. Add raw sonar files (e.g. metadata extracted and processed bathymetry data converted to .qpd, including vessel configuration and sound velocity)
3. Add tide zoning file (.zdf) and associated tide data and integrate into raw files
4. Create dynamic surface with shallow water CUBE settings enabled
5. Review and edit soundings/clean surface with 3D editor tool
6. Export final surface to .BAG file and CUBE surface
7. Export processed bathy in .GSF format

CUBE

A CUBE (Combined Uncertainty and Bathymetry Estimator) surface was created for editing and as a starting point for final products. The ‘Shallow Water’ configuration (Figure 10) was selected for each surface based on a recommendation by QPS support engineers who confirmed these CUBE parameters were in accordance with those employed by NOAA. All CUBE settings in this configuration are constant for all grid resolutions except for the CUBE capture distance, which equals $0.71 \times$ grid resolution. The mainscheme survey was gridded at 2 and 4 meters, and the inshore survey was gridded at 1, 2, and 4 meters, based on the average depth of the area and in accordance with NOAA’s survey recommendations (NOAA, 2014). Manual editing of soundings was performed in the 3D editor tool of Qimera.

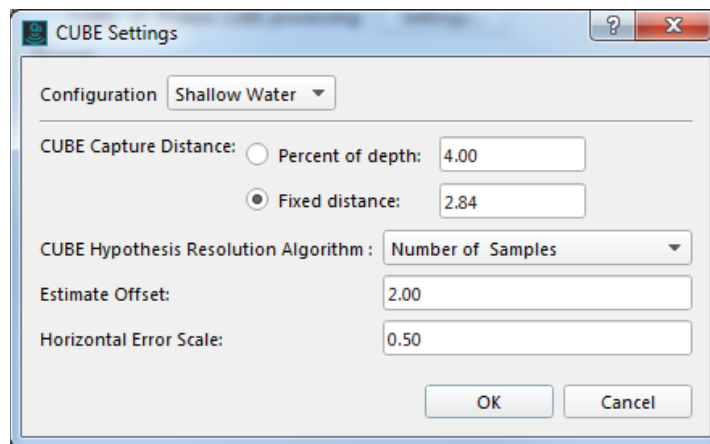

Figure 10. CUBE settings parameters window shown with shallow water settings for 4-meter grid resolution.

****Important Note on Inshore Data Processing****

After creating the initial surface for the 2016 inshore data, it became apparent that there was an issue with raw sonar database file 0052_165504_042916_Townsend_Gut-0001.db, which also revealed an associated bug in Qimera (v.1.3.6). Briefly, Qimera was unable to apply the draft value after applying tide data to the processed sonar file (.qpd format). As a result, all data associated with this file were vertically offset by 0.85 meters (0.85 meters shallower than the surrounding surface). This static offset was confirmed (and reproduced by QPS technicians) by performing a surface difference test between the erroneous file and the surrounding surface (Figure 11). To compensate for this offset, a static offset equal to the draft (0.85 meters) was applied to the data in the erroneous file. This offset applies to this file only where it is included in surfaces submitted for inshore survey data. After applying the static offset, a second surface difference test was performed to confirm the vertical match of these data with the surrounding surface (Figure 12). A full explanation and details related to the discovery of this issue, the steps taken as a work-around to ensure incorporation of the data into the final surface, and corrective actions taken by QPS support technicians are outlined in Appendix F.

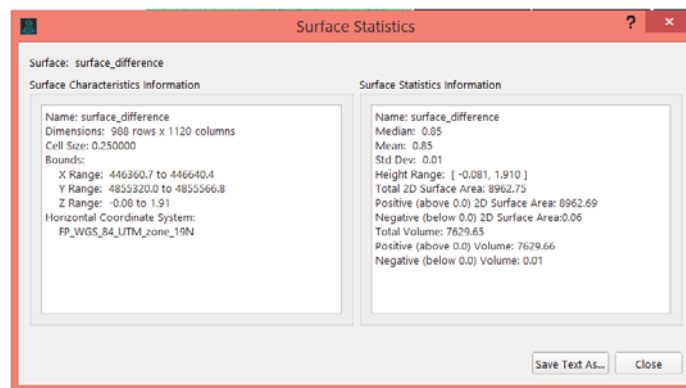

Figure 11. Surface difference results showing static offset of 0.85 meters (equal to draft) after tide data were applied to processed data for file 0052_165504_042916_Townsend_Gut-0001.db.

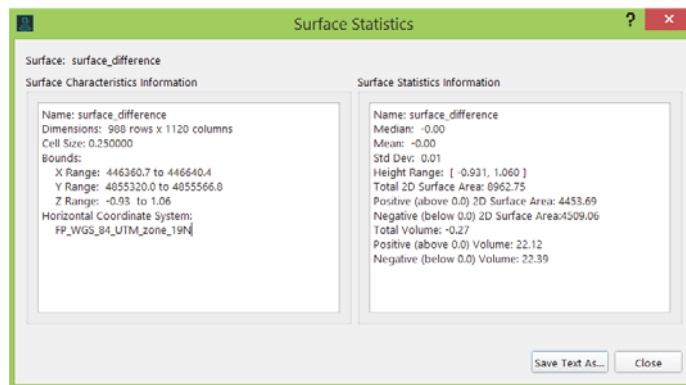

Figure 12. Surface difference results showing vertical match after applying static offset of 0.85 meters (equal to draft) to processed data for 0052_165504_042916_Townsend_Gut-0001.db.

7.0 Results

7.1 Final Surfaces

The surfaces and BAGs listed in Table 9 were submitted with the survey data.

Table 9. Surfaces submitted with 2016 survey data

Surface Name	Resolution (m)	Depth Range (m)	Surface Parameter
MCMI_mainscheme_2016_4m_MLLW	4.0	2 - 135	NOAA_4m
MCMI_mainscheme_2016_2m_MLLW	2.0	2 - 135	NOAA_2m
MCMI_crosslines_2016_4m_MLLW	4.0	4 - 136	NOAA_4m
MCMI_inshore_2016_4m_MLLW	4.0	0 - 82	NOAA_4m
MCMI_inshore_2016_2m_MLLW	2.0	0 - 82	NOAA_2m
MCMI_inshore_2016_1m_MLLW	1.0	0 - 82	NOAA_1m

7.2 Backscatter

Backscatter was logged in the raw .db files. The .db files also hold the navigation record and bottom detections for all lines of surveys. Processed files containing multibeam backscatter data (snippets and beam-average) were exported from Qimera v.1.3.6. in .GSF format. QPS Fledermaus Geocoder Toolbox (FMGT) v.7.7.0 (Build 372, 64-bit edition) was used to import, process, and mosaic time-series backscatter data. Backscatter mosaics of mainscheme and inshore data are shown in Figures 13 and 14, respectively. The GSF files containing the extracted were submitted with the data in this survey. Processed mosaics (Table 10) were saved in geoTiff format and also submitted.

Table 10. Backscatter mosaics submitted with 2016 survey data

Mosaic Name	Pixel Size (m)
MCMI_mainscheme_backscatter_2016_4m	4.0
MCMI_mainscheme_backscatter_2016_2m	2.0
MCMI_inshore_backscatter_2016_4m	4.0
MCMI_inshore_backscatter_2016_2m	2.0
MCMI_inshore_backscatter_2016_1m	1.0

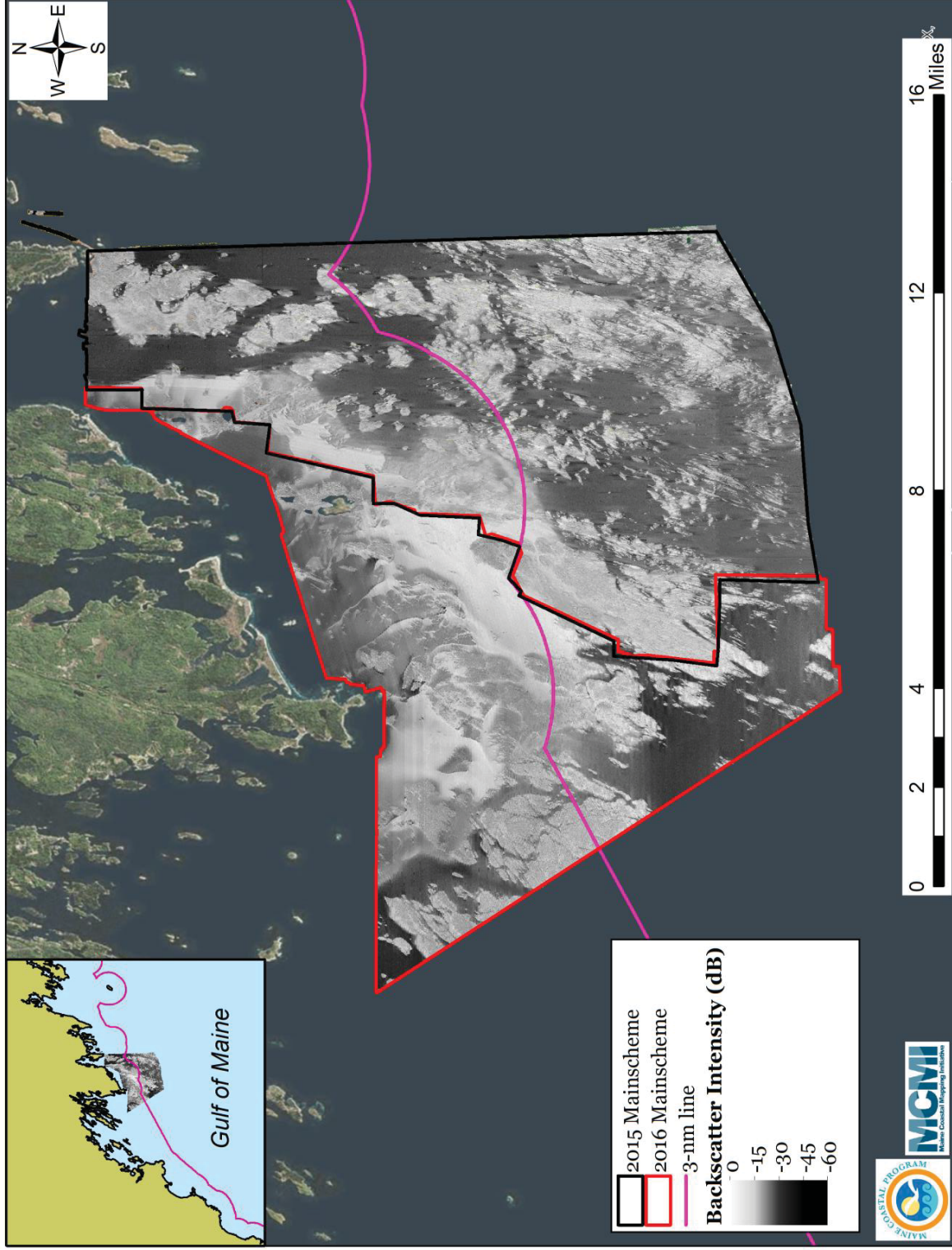

Figure 13. Combined backscatter mosaic (4-meter pixel size) of 2015 (black outline) and 2016 (red outline) mainscheme surveys.

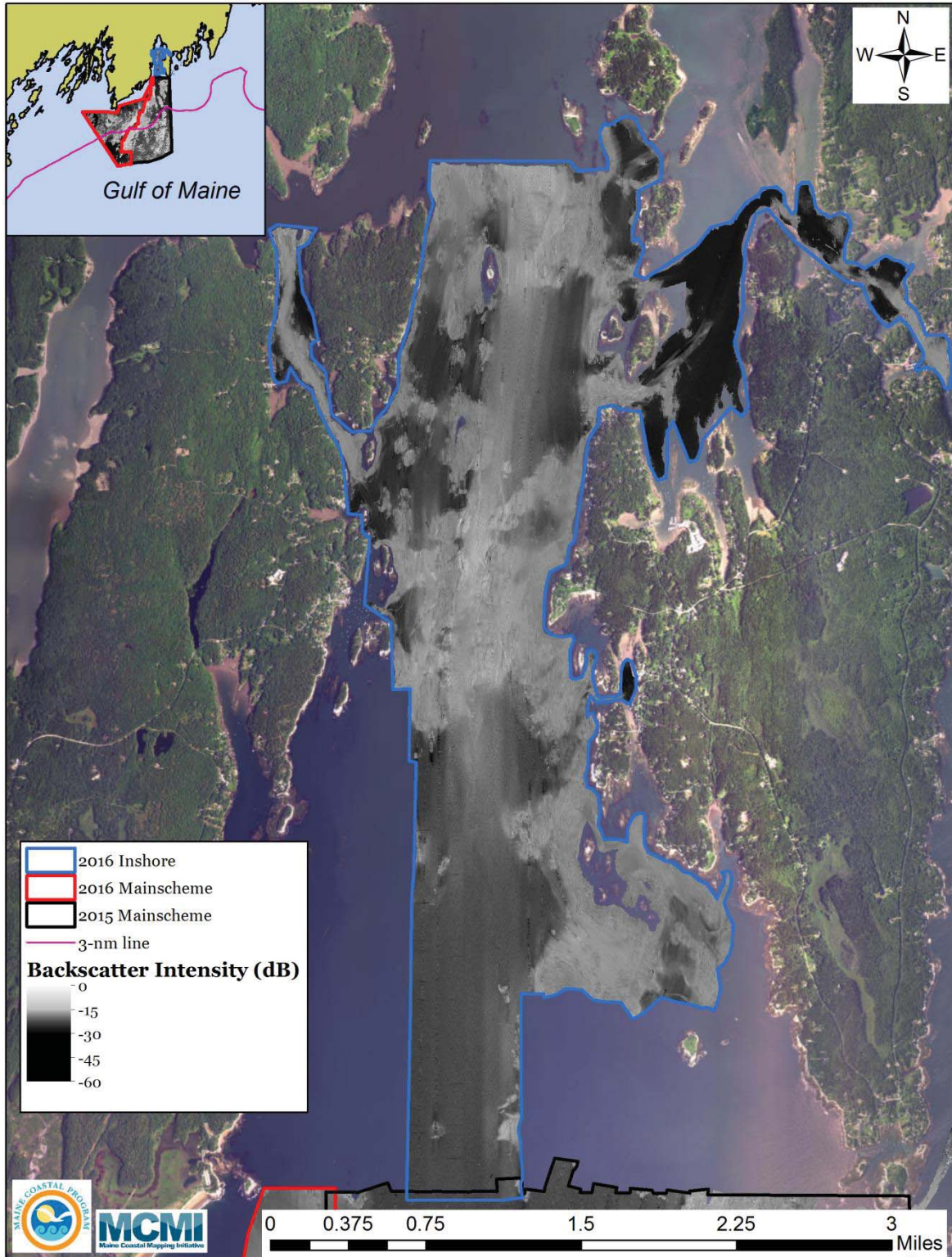

Figure 14. Inshore 2016 backscatter intensity (4-meter grid) mosaic.

7.3 Charts and Prior Surveys

The largest scale raster navigational charts which cover the survey areas are listed in Table 11. Prior hydrographic surveys in the vicinity were conducted by NOAA between 1940 and 1969 and consisted only of partial bottom coverage. The most recent hydrographic survey data for the southern-most portions of the mainscheme survey area took place prior to 1900. These data were not compared with data collected by the MCMI.

Table 11. Largest scale raster charts in survey areas

Chart	Scale	Source Edition	Source Date	NTM Edition	NTM Date
13286	1:80,000	32	12/1/2013	27	2/28/2015
13288	1:80,000	43	7/1/2010	95	2/28/2015
13290	1:40,000	39	7/1/2010	98	2/28/2015
13293	1:40,000	35	10/1/2010	84	2/28/2015
13295	1:15,000	12	5/1/2013	27	2/28/2015
13296	1:15,000	26	1/1/2012	50	2/28/2015

7.4 Bottom Samples

Grab sampling data was used to supplement existing seafloor substrate data collected in the immediate vicinity of the mainscheme survey area. A total of 54 bottom samples, 43 in state water and 11 in federal waters, were collected to supplement existing sediment data collected previously by other agencies in the 2015/2016 mainscheme survey areas (Figure 15). The results of grain-size and video analyses were used to calibrate, refine, and digitize interpretations of seafloor substrate using backscatter intensity, bathymetry, and first-order bathymetry derivatives (e.g. slope, aspect, and rugosity). These data were also used to investigate how these data relate to benthic infauna in the survey area. Sediment and infauna analyses are presented in Dobbs (2017b) and Ozmon (2017), respectively.

7.5 Seafloor Anomalies

For the purposes of this report, seafloor anomalies consist of unidentified seabed features that do not exhibit distinctly natural or anthropogenic characteristics but deviate notably from the surrounding seabed. The locations of many anomalies were noted in real-time during surveying and were later reviewed during post-processing. After removing insignificant anomalies, a total of 14 seabed anomalies in the mainscheme survey area were selected for notation. 7 of the 14 anomalies lie within a danger zone (presumably a relic of previous military activity) noted in chart 13288. These features do not pose a hazard to navigation and are simply noted as potential features of interest. An anomaly map, coordinates, basic attributes, generalized descriptions, and sounding imagery are provided in Appendix G.

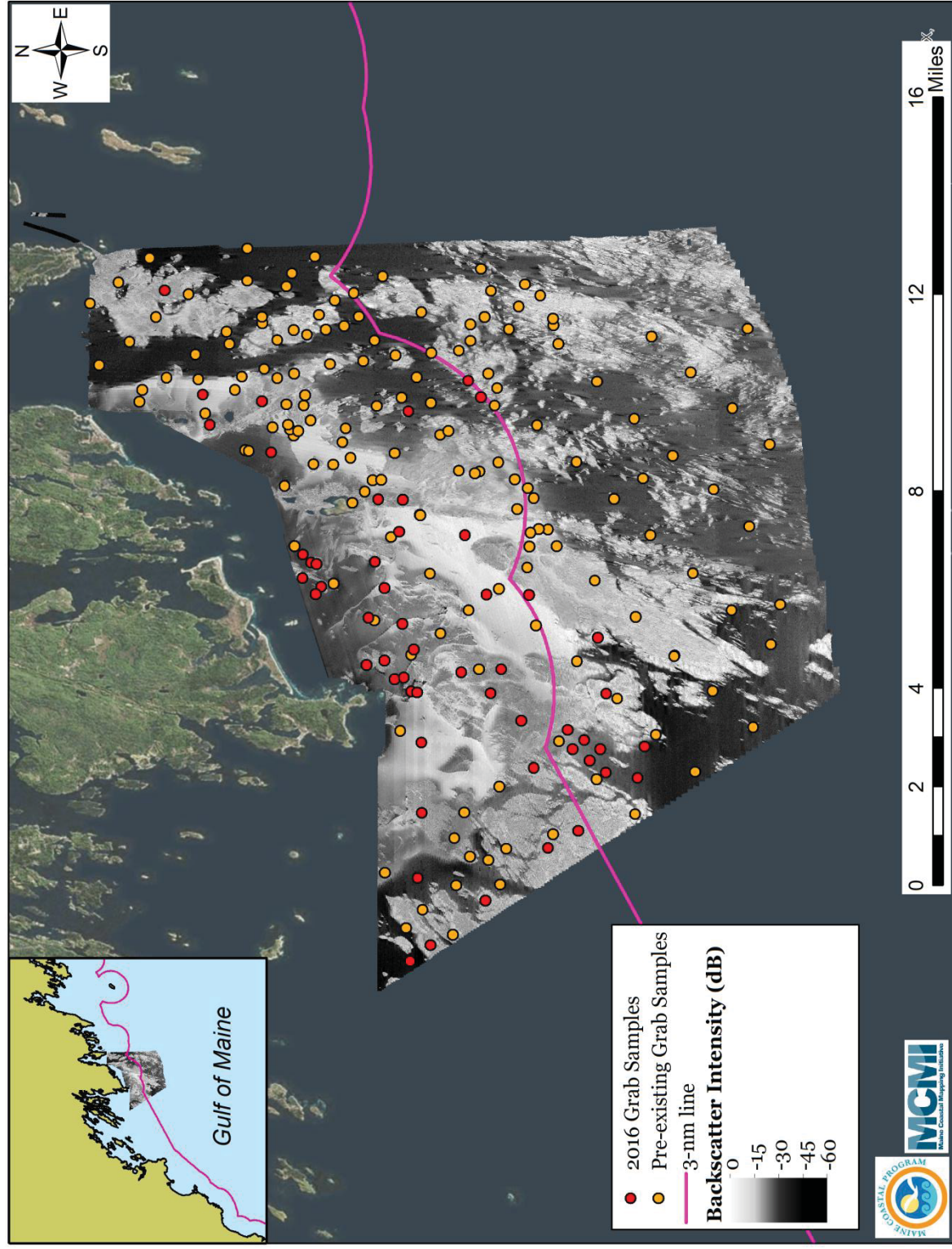

Figure 15. Grab sample locations with 2015 and 2016 mainscheme survey areas. Red circles represent grabs collected during the 2016 survey season. Orange circles represent all pre-existing sample sites collected in the survey areas by various agencies.

8.0 Summary

A total of approximately 62 mi² (161 km²), 57 mi² (148 km²) mainscheme and 5 mi² (13 km²) inshore, of high-resolution multibeam data were collected by MCMI between April and October 2016. Multibeam coverage was at least 100% in all areas surveyed. Mainscheme and inshore surveys were processed with 2 and 4 m and 1, 2, and 4 m grid resolution, respectively. The consistency of hydrographic data collected aboard the R/V Amy Gale was reflected in the results of the surface difference tests between crosslines and junction survey data, where mean vertical differences for all tests were less than 0.08 meters. Standard deviations of all tests were relatively low and comparable to those achieved by small NOAA vessels (e.g. *Ferdinand R. Hassler*) for similar surveys in Maine's coastal waters.

MCMI has utilized final data products for high-resolution backscatter and bathymetry to refine existing seafloor sediment maps and determine the spatial extent of sand deposits within federal water. When combined with existing geophysical (e.g. seismic reflection profiles and side-scan sonar) data, these data may also be used to refine interpretations of coastal/nearshore geomorphology and three-dimensional assessments of potential sediment resources/valley fill in the region. In addition, these data are a critical component of benthic habitat classification and modeling performed by MCMI (see Ozmon, 2017). Overall, these data have a variety of applications and are an invaluable resource to public and private agencies who wish to more effectively manage and understand coastal and marine resources.

References

Barnhardt, W.A., 1994. Late Quaternary sea-level change and evolution of the Maine inner continental shelf 12-7 ka B.P.: Ph.D. dissertation, University of Maine, Orono, Maine, 196 p.

Barnhardt, W.A., Kelley, J.T., Dickson, S.M., and Belknap, D.F., 1998. Mapping the Gulf of Maine with side-scan sonar: A new bottom-type classification for complex seafloors. *Journal of Coastal Research*, Vol. 14, No. 2, pp. 646-659.

Dobbs, K.M., 2016. Preliminary report of Saco River submerged debris investigation. Maine Coastal Mapping Initiative, Maine Coastal Program, Augusta, ME. 45 p.

Dobbs, K.M., 2017a. 2016 Descriptive report for seafloor mapping – Federal Navigation Channel of Saco River, Biddeford/Saco to Camp Ellis, Maine. Maine Coastal Mapping Initiative, Maine Coastal Program, Augusta, ME. 43 p.

Dobbs, K.M., 2017b. 2016 Seafloor sediment analysis and mapping: Mid-coast Maine. Maine Coastal Mapping Initiative, Maine Coastal Program, Augusta, ME. 120 p.

NOAA, 2014. NOS hydrographic surveys specifications and deliverables: U.S Department of Commerce National Oceanic and Atmospheric Administration. Page 89.

Ozmon, I.M., 2017. 2015 Benthic habitat classification report (Manuscript). Maine Coastal Mapping Initiative, Maine Coastal Program, Augusta, ME. January 2017.

U.S. Department of the Interior, 2014. Proposed geophysical and geological activities in the Atlantic OCS to identify sand resources and borrow areas north Atlantic, mid-Atlantic, and south Atlantic-Straits of Florida planning areas, *final environmental assessment*. OCS EIS/EA BOEM 2013-219 U.S. Department of the Interior Bureau of Ocean Energy Management Division of Environmental Assessment Herndon, VA, January 2014.

Appendix A – Specific dates of data acquisition for mainscheme and inshore surveys

Dates (mm/dd/yyyy) of Data Acquisition for 2016 Surveys*		
Mainscheme	Mainscheme Crosslines	Inshore
04/28/16	08/30/16	04/29/16
05/10/16	08/31/16	05/02/16
05/12/16	09/01/16	05/04/16
05/18/16	09/02/16	05/09/16
06/01/16		05/10/16
06/15/16		05/13/16
06/16/16		05/17/16
06/17/16		06/03/16
06/22/16		06/08/16
06/24/16		06/10/16
06/30/16		06/14/16
07/01/16		06/22/16
07/05/16		06/29/16
07/06/16		
07/11/16		
07/12/16		
07/13/16		
07/18/16		
07/19/16		
07/21/16		
07/25/16		
07/26/16		
07/27/16		
07/28/16		
07/29/16		
08/01/16		
08/02/16		
08/03/16		
08/08/16		
08/09/16		
08/12/16		
08/15/16		
08/16/16		
08/18/16		
09/07/16		
09/08/16		
09/09/16		
09/16/16		
09/19/16		
09/21/16		
09/22/16		
10/03/16		
10/07/16		

*Dates of Saco River survey not listed.

Appendix B – Configuration settings for Seapath 330

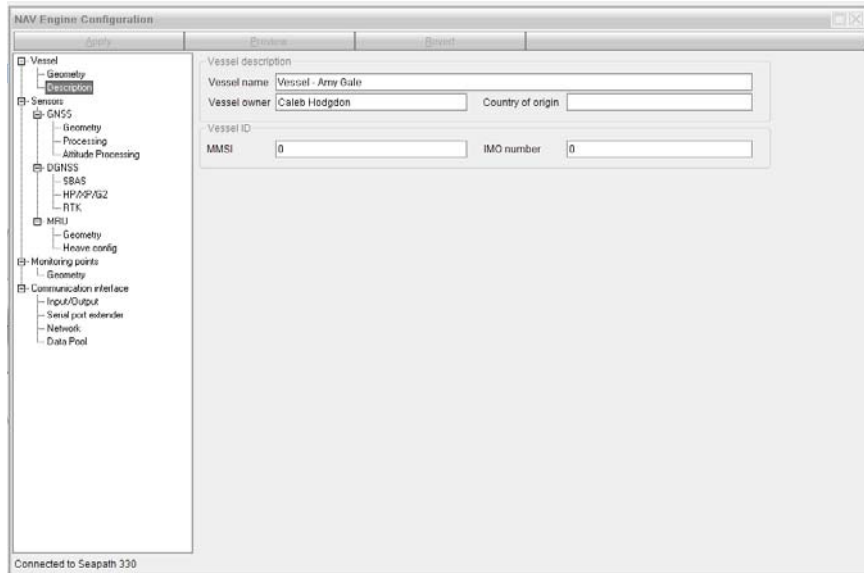
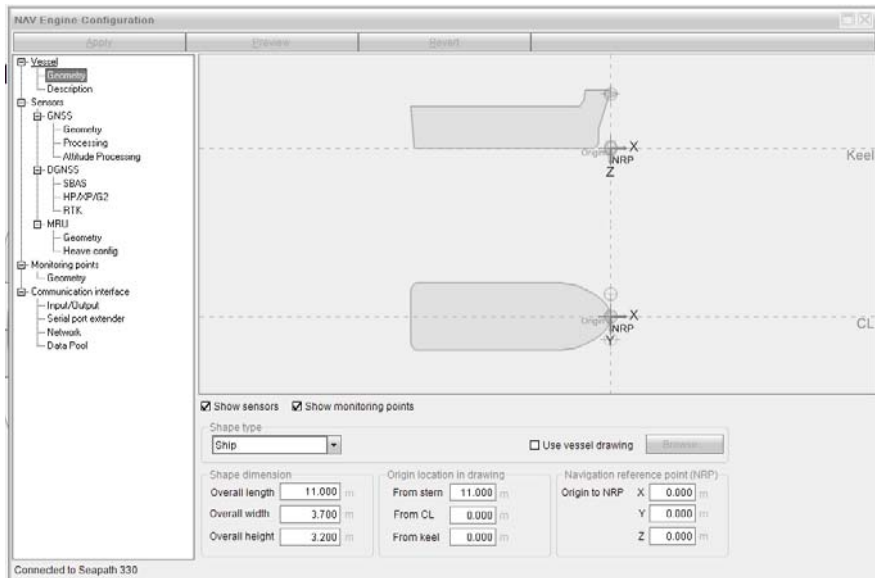

NAV Engine Configuration

apply Preview Revert

- Vessel
 - Geometry
 - Description
- Sensors
 - GNSS
 - Geometry
 - Processing
 - Altitude Processing
 - DGNSS
 - SBAS
 - HPA/P/G2
 - RTK
 - MRU
 - Geometry
 - Heave config
 - Monitoring points
 - Geometry
 - Communication interface
 - Input/Output
 - Serial port extender
 - Network
 - Data Pool

Show sensors Show monitoring points

Antenna configuration

Antenna type: NOV7020G NONE Antenna beam

Antenna location (from Origin)

	Position [m]		
	X	Y	Z
Antenna 1	0.155	-1.25	-3.007
Antenna 2	0.155	1.25	-3.007

Antenna offset (from antenna 1 to antenna 2)

Baseline length: 2.500 m
 Heading offset: 270.000 °
 Height difference: 0.000 m

Calibration wizard

Connected to Seapath 330

NAV Engine Configuration

apply Preview Revert

- Vessel
 - Geometry
 - Description
- Sensors
 - GNSS
 - Geometry
 - Processing
 - Altitude Processing
 - DGNSS
 - SBAS
 - HPA/P/G2
 - RTK
 - MRU
 - Geometry
 - Heave config
 - Monitoring points
 - Geometry
 - Communication interface
 - Input/Output
 - Serial port extender
 - Network
 - Data Pool

Height aiding

Aid mode: Off

SV masking

Elevation mask: 10 °

Integrity

Accuracy level: 10.00 m

Ionosphere

Ionosphere activity: Normal

Connected to Seapath 330

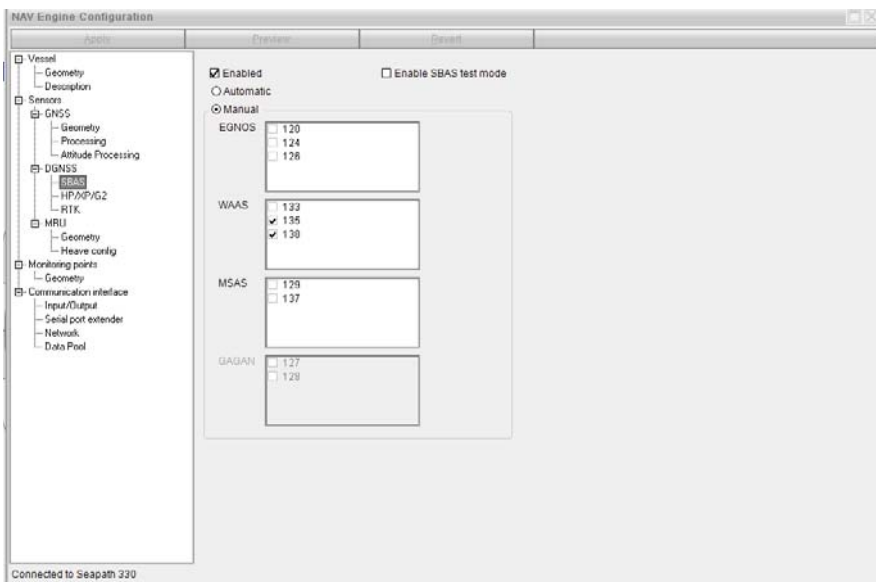
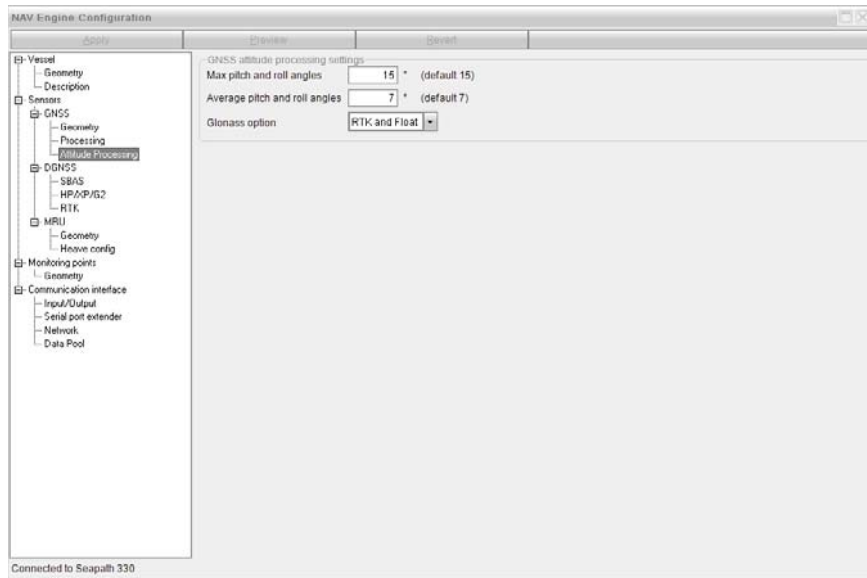

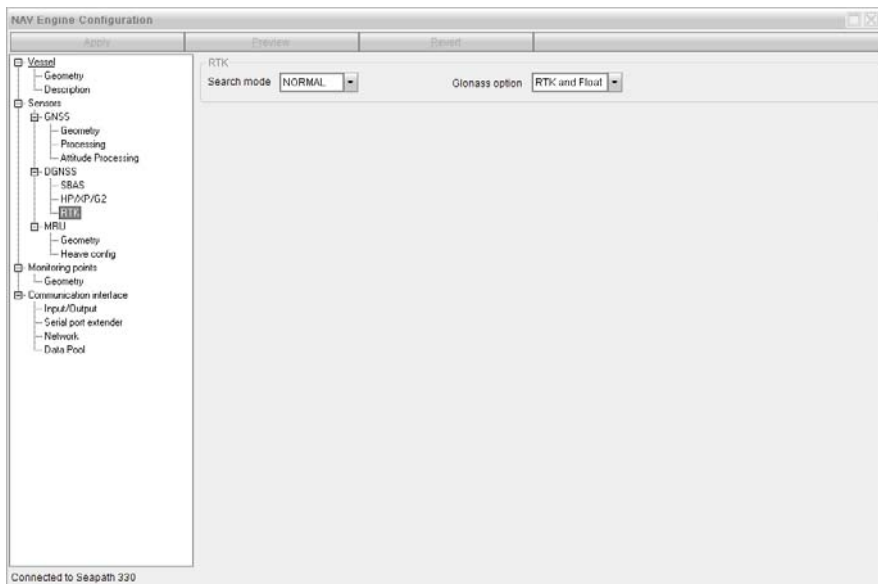
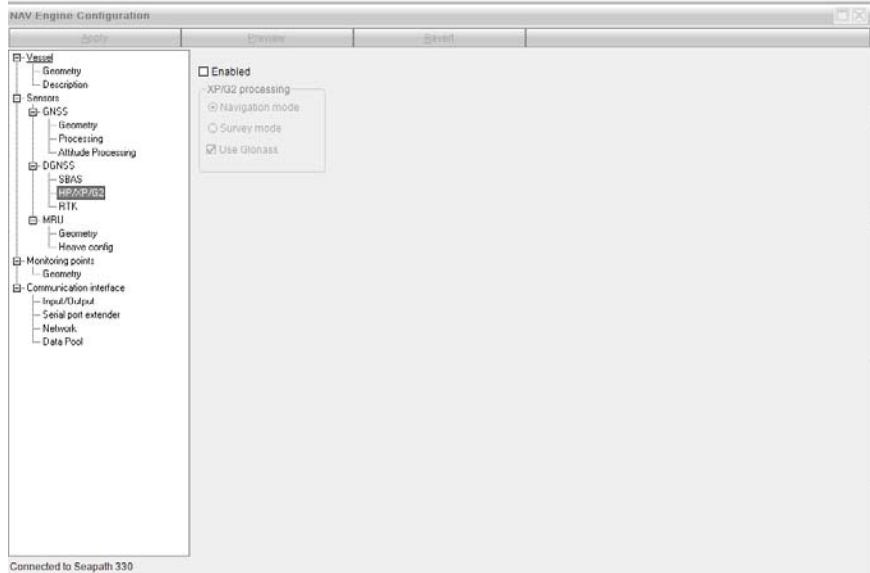

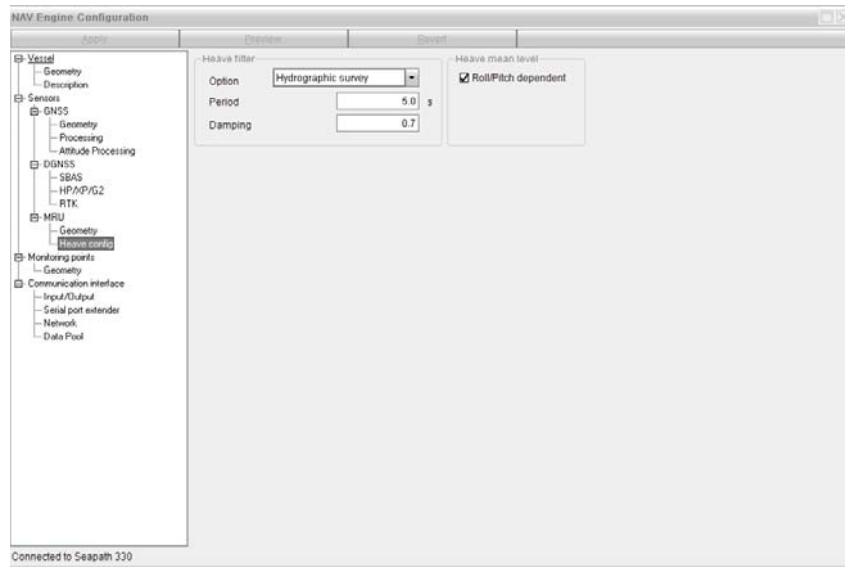
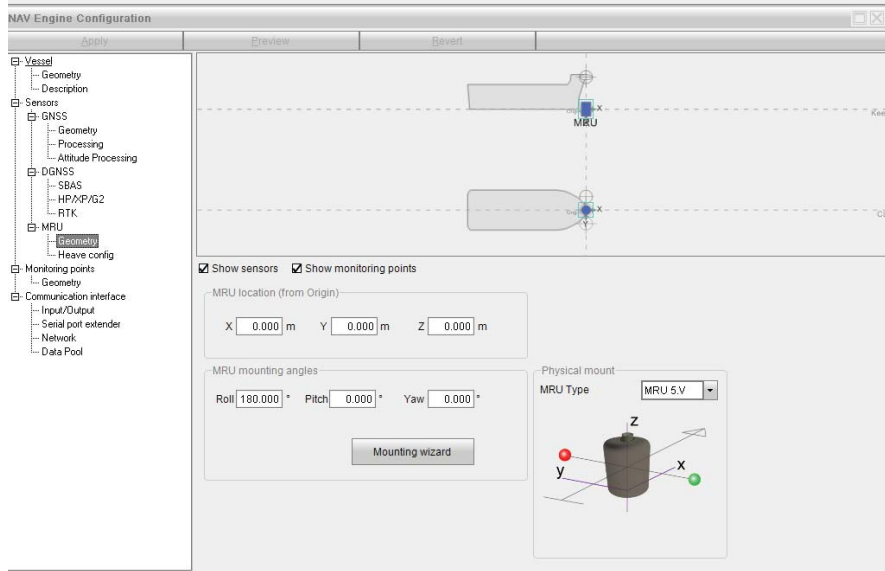

NAV Engine Configuration

Apply | Preview | Revert

- Vessel
 - Geometry
 - Description
- Sensors
 - GNSS
 - Geometry
 - Processing
 - Attitude Processing
 - DGNSS
 - SBAS
 - HP/XP/G2
 - RTK
 - MRU
 - Geometry
 - Heave config
 - Monitoring points
 - EM2040C**
 - Communication interface
 - Input/Output
 - Serial port extender
 - Network
 - Data Pool

Show sensors

ID	Name	Position [m]		
		X	Y	Z
1	EM2040C	0.039	0.000	0.132

Monitoring points are entered relative to Origin

Connected to Seapath 330

NAV Engine Configuration

Apply | Preview | Revert

- Vessel
 - Geometry
 - Description
- Sensors
 - GNSS
 - Geometry
 - Processing
 - Attitude Processing
 - DGNSS
 - SBAS
 - HP/XP/G2
 - RTK
 - MRU
 - Geometry
 - Heave config
 - Monitoring points
 - EM2040C
 - Communication interface
 - Input/Output
 - Serial port extender
 - Network
 - Data Pool

Interface	Type	Direction	UID Properties	Description
<input checked="" type="checkbox"/> GrrsRec1	Serial	In/Out	GNSSA1 57600 n 8 1	Receiver #1
<input checked="" type="checkbox"/> GrrsRec2	Serial	In/Out	GNSSB1 57600 n 8 1	Receiver #2
<input checked="" type="checkbox"/> MRU	Serial	In/Out	MRU 115200 n 8 1 vs-422	MRU #1
<input type="checkbox"/> DgnssLink1	Serial	In	COM11 9600 n 8 1 vs-232	Link #1
<input type="checkbox"/> DgnssLink2	Serial	In	COM9 38400 n 8 1 vs-232	Link #2
<input type="checkbox"/> DgnssLink3	Serial	In	NONE	Link #3
<input type="checkbox"/> DgnssLink4	Serial	In	NONE	Link #4
<input type="checkbox"/> ConnectorRadio1	Serial	In	NONE	
<input type="checkbox"/> ConnectorRadio2	Serial	In	NONE	
<input type="checkbox"/> ConnectorRadio3	Serial	In	NONE	
<input type="checkbox"/> ConnectorRadio4	Serial	In	NONE	
<input checked="" type="checkbox"/> TelegramOut1	Serial	Out	COM9 9600 n 8 1 vs-332	POSITION TO EM2040C
<input checked="" type="checkbox"/> TelegramOut2	Serial	Out	COM10 19200 n 8 1 vs-232	SIRRAD EM3000 to EM2040C
<input checked="" type="checkbox"/> TelegramOut3	Ethernet	Out	UDP LAN3 3001 BROADCAST	ATTITUDE VELOCITY TO EM2...
<input checked="" type="checkbox"/> TelegramOut4	Serial	Out	COM2 9600 n 8 1	POSITION TO QINSY
<input checked="" type="checkbox"/> TelegramOut5	Ethernet	Out	UDP LAN4 13001 BROADCAST	ATTITUDE VELOCITY TO QINSY
<input type="checkbox"/> TelegramOut6	Out	NONE		Telegram Out #6
<input type="checkbox"/> TelegramOut7	Out	NONE		Telegram Out #7
<input type="checkbox"/> TelegramOut8	Out	NONE		Telegram Out #8
<input type="checkbox"/> TelegramOut9	Out	NONE		Telegram Out #9
<input type="checkbox"/> TelegramOut10	Out	NONE		Telegram Out #10
<input type="checkbox"/> TelegramOut11	Out	NONE		Telegram Out #11
<input type="checkbox"/> TelegramOut12	Out	NONE		Telegram Out #12
<input type="checkbox"/> TelegramOut13	Out	NONE		Telegram Out #13
<input type="checkbox"/> TelegramOut14	Out	NONE		Telegram Out #14
<input type="checkbox"/> TelegramOut15	Out	NONE		Telegram Out #15
<input type="checkbox"/> TelegramOut16	Out	NONE		Telegram Out #16
<input type="checkbox"/> AnalogOut1	Analog	Out	Gain: 0.0000, offset: 2.0000	Analog Out #1
<input type="checkbox"/> AnalogOut2	Analog	Out	Gain: 0.0000, offset: -5.0000	Analog Out #2
<input type="checkbox"/> AnalogOut3	Analog	Out	Gain: 0.0000, offset: 7.0000	Analog Out #3

Connected to Seapath 330

Disabled | OK | Warning | Error

NAV Engine Configuration

Options | Settings

Input/Output list

Interface	Type	Direction	I/O Properties	Description
<input type="checkbox"/> GpsRec1	Serial	In/Out	GNSS81 57600 n 8 1	Receiver #1
<input checked="" type="checkbox"/> GpsRec2	Serial	In/Out	GNSS81 57600 n 8 1	Receiver #2
<input checked="" type="checkbox"/> MRU	Serial	In/Out	MRU 115200 n 8 1 rs-422	IMU #1
<input type="checkbox"/> GYRO1	Serial	In	COM11 9600 n 8 1 rs-232	Gyro #1
<input type="checkbox"/> GpsLink1	Serial	In	COM9 38400 n 8 1 rs-232	Link #1

Configuration details

Interface: Description:

Type:

Cable ID:

I/O properties

Port: Baud rate: rs-232 rs-422

Advanced

Parity: Data bits: Stop bits:

Connected to SeaSwath 330

NAV Engine Configuration

Options | Settings

Input/Output list

Interface	Type	Direction	I/O Properties	Description
<input checked="" type="checkbox"/> GpsRec1	Serial	In/Out	GNSSA1 57600 n 8 1	Receiver #1
<input checked="" type="checkbox"/> GpsRec2	Serial	In/Out	GNSSB1 57600 n 8 1	Receiver #2
<input checked="" type="checkbox"/> MRU	Serial	In/Out	MRU 115200 n 8 1 rs-422	IMU #1
<input type="checkbox"/> GYRO1	Serial	In	COM11 9600 n 8 1 rs-232	Gyro #1
<input type="checkbox"/> GpsLink1	Serial	In	COM9 38400 n 8 1 rs-232	Link #1

Configuration details

Interface: Description:

Type:

Cable ID:

I/O properties

Port: Baud rate: rs-232 rs-422

Advanced

Parity: Data bits: Stop bits:

Connected to SeaSwath 330

NAV Engine Configuration

Summary Overview Details

Input/Output list

Interface	Type	Direction	I/O Properties	Description
<input checked="" type="checkbox"/> GncRec1	Serial	In/Out	GNSSA1 57600 n 8 1	Receiver #1
<input checked="" type="checkbox"/> GncRec2	Serial	In/Out	GNSSB1 57600 n 8 1	Receiver #2
<input checked="" type="checkbox"/> IMU1	Serial	In/Out	COM9 115200 n 8 rs-422	IMU #1
<input type="checkbox"/> Sps1	Serial	In	COM11 3600 n 8 rs-232	Sps #1
<input type="checkbox"/> DgnedLck1	Serial	In	COM9 3600 n 8 rs-232	Lck #1

Configuration details

Interface: Description:

Type:

Cable ID:

I/O properties

Port: Baud rate: rs-232 rs-422

Advanced

Parity: Data bits: Stop bits:

Connected to Seapath 330

NAV Engine Configuration

Summary Overview Details

Input/Output list

Interface	Type	Direction	I/O Properties	Description
<input checked="" type="checkbox"/> TelegramOut1	Serial	Out	COM9 2600 n 8 rs-232	POSITION TO EM2040C
<input checked="" type="checkbox"/> TelegramOut2	Serial	Out	COM10 18200 n 8 rs-232	SIMRAD EM3000 to EM2040C
<input checked="" type="checkbox"/> TelegramOut3	Ethernet	Out	UDP LAN3 3001 BROADCAST	ATTITUDE VELOCITY TO EM2...
<input checked="" type="checkbox"/> TelegramOut4	Serial	Out	COM2 3600 n 8 1	POSITION TO QINSY
<input checked="" type="checkbox"/> TelegramOut5	Ethernet	Out	UDP LAN4 13001 BROADCAST	ATTITUDE VELOCITY TO QINSY

Configuration details

Interface: Description:

Type:

Cable ID:

I/O properties

Port: Baud rate: rs-232 rs-422

Advanced

Parity: Data bits: Stop bits:

Telegram out properties

Format: Datum: Monitoring point:

NMEA selection:

Options:

NMEA talker ID: Log to file Time precision:

Telegram timing

Interval [s]: Event driven Timer driven

Connected to Seapath 230

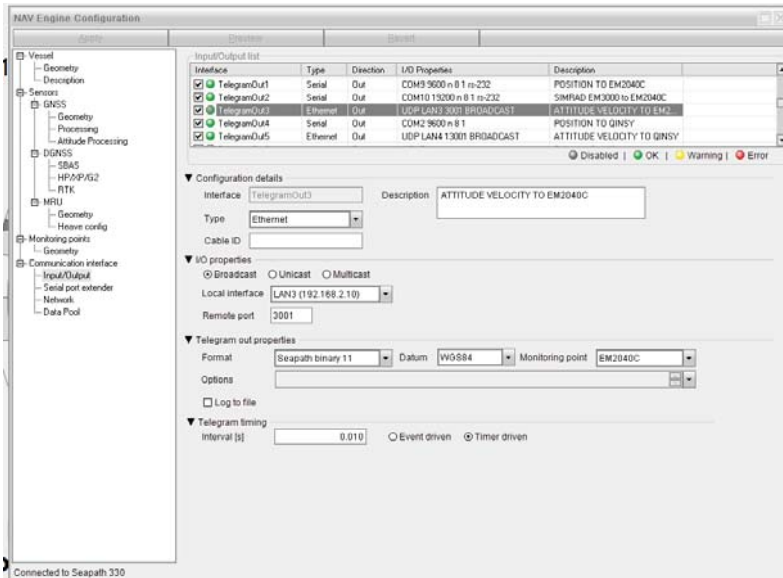
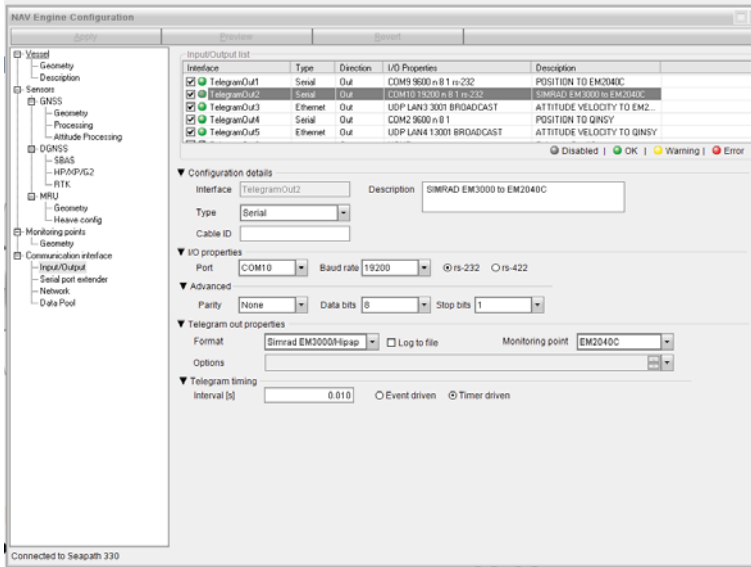

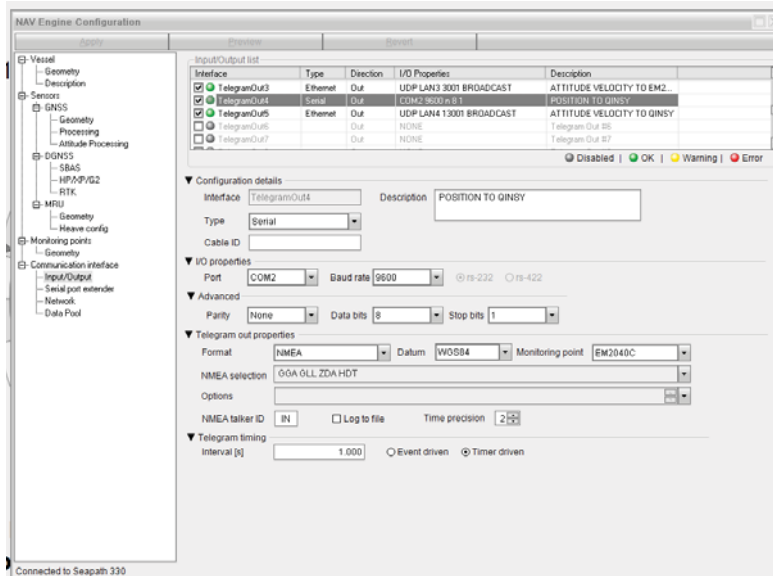
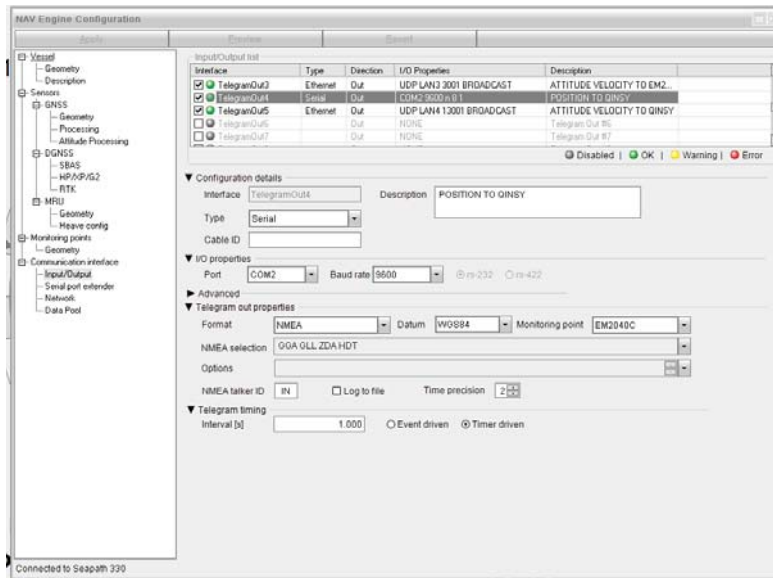

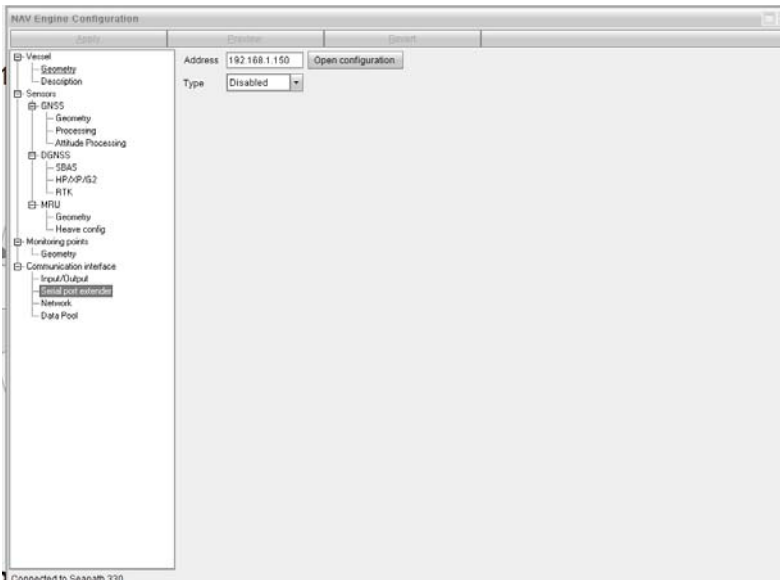
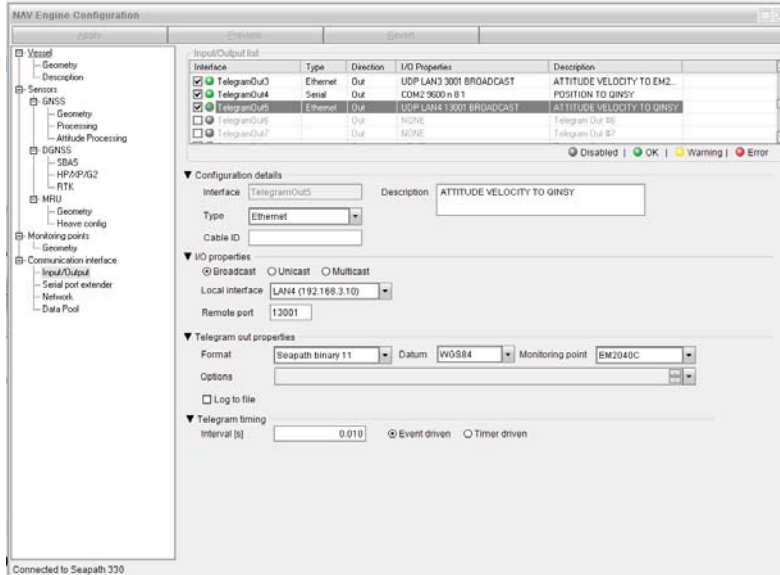

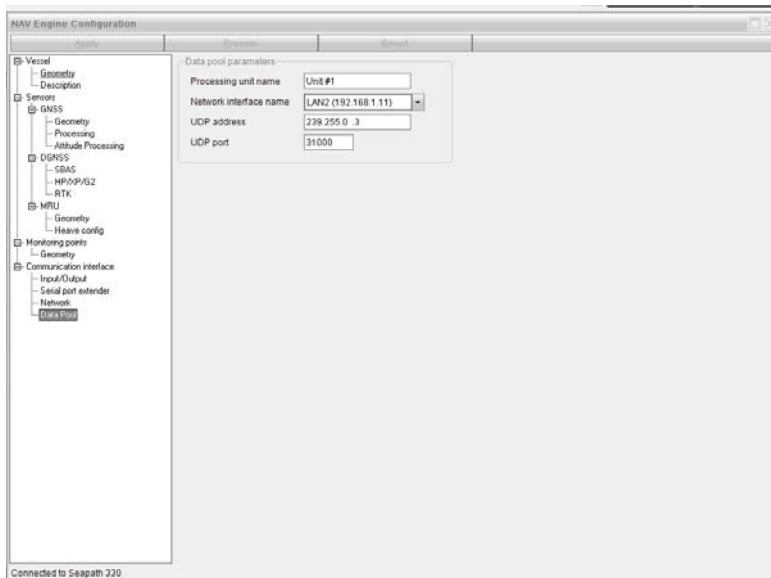
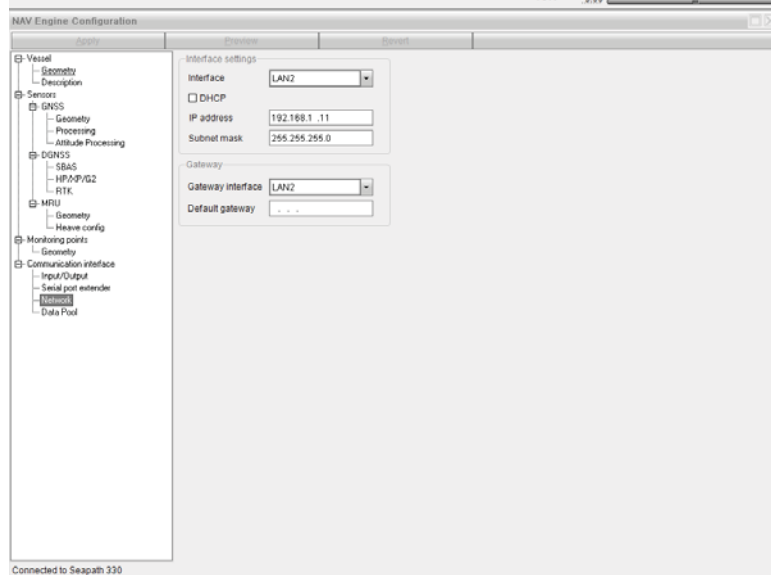

Appendix C – Template database settings in QINSy

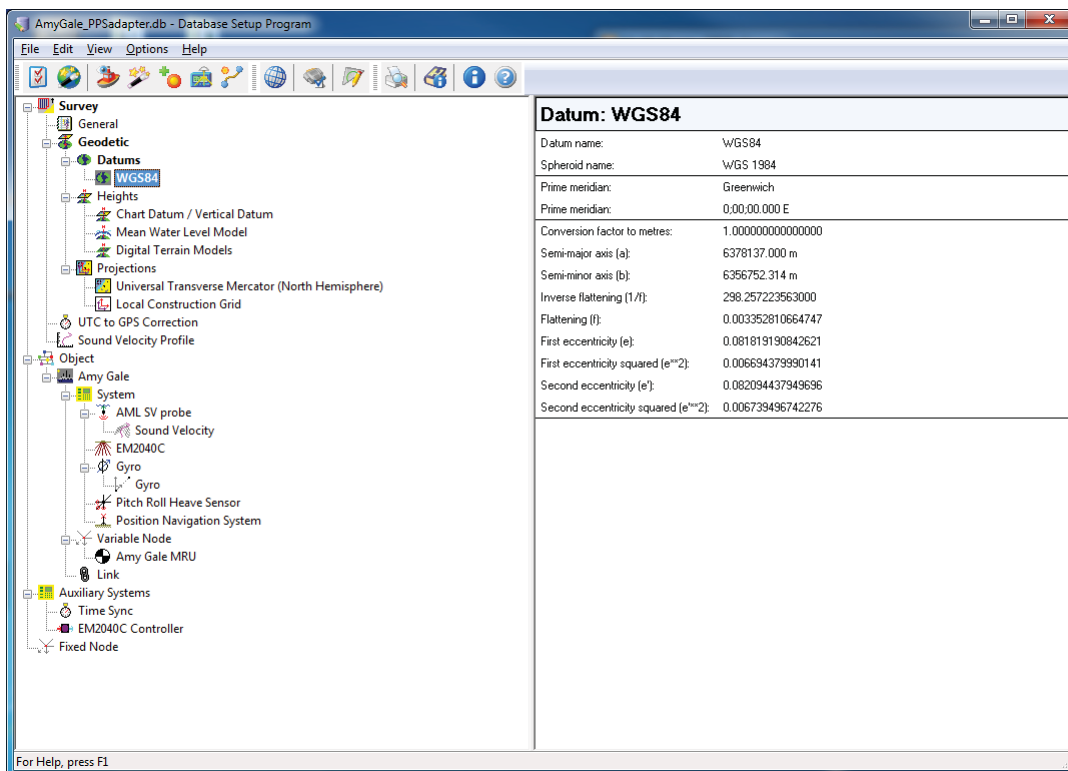
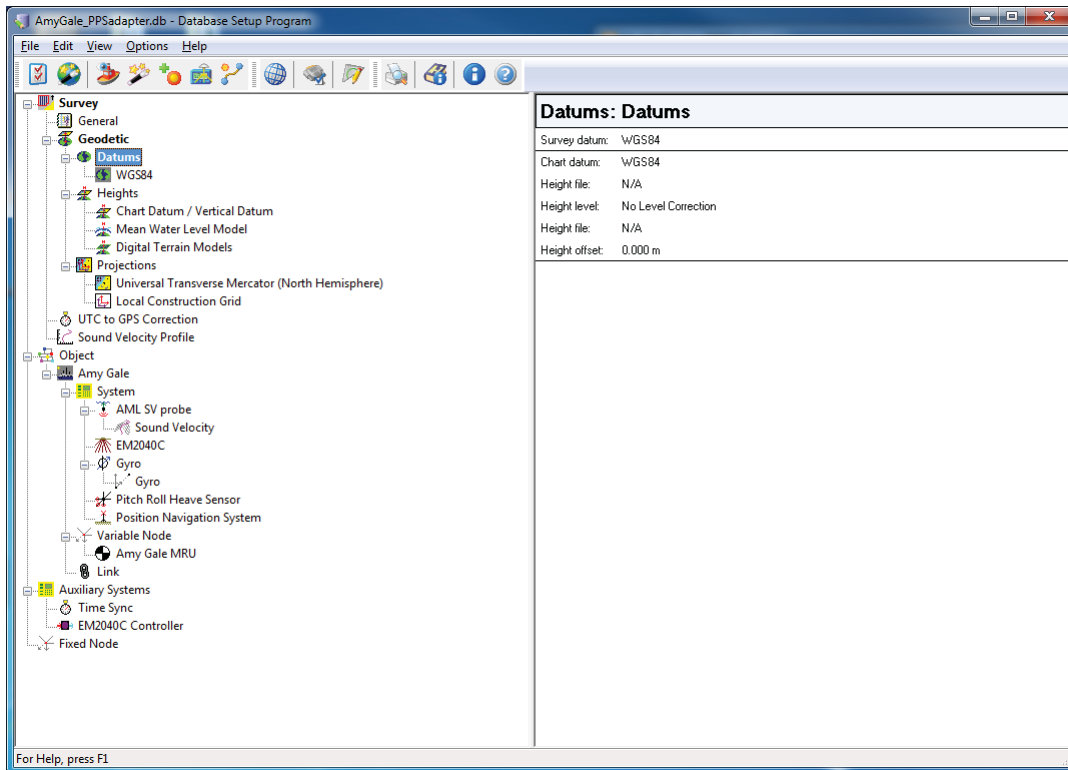

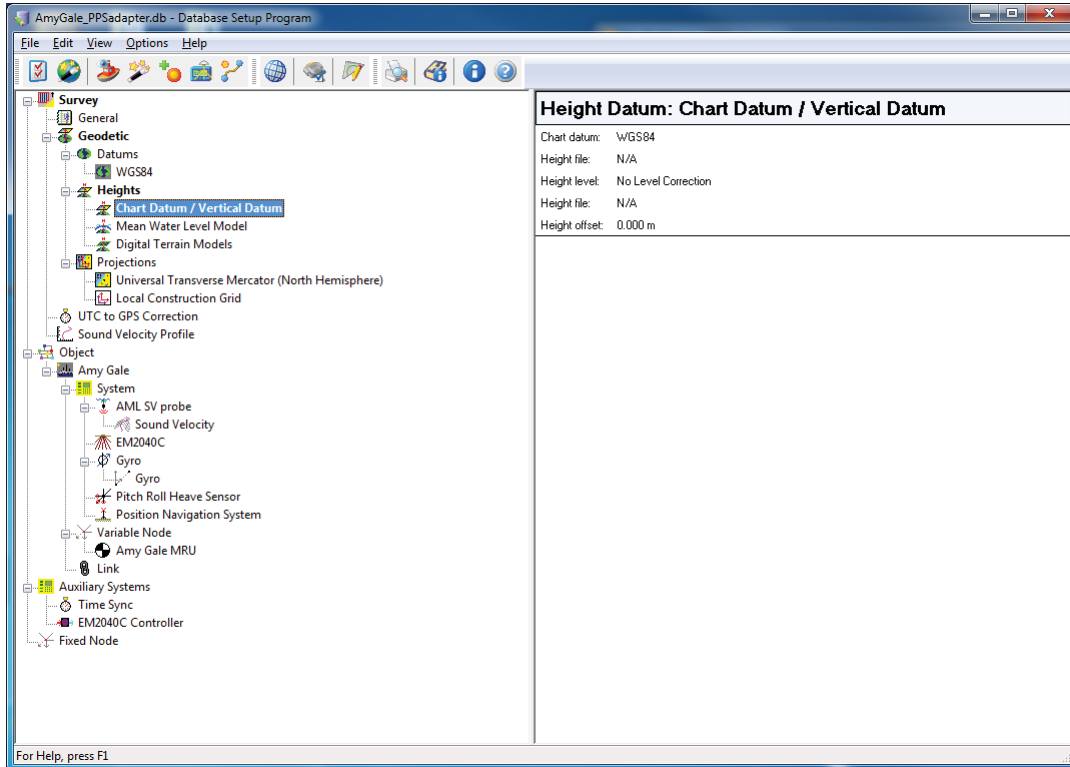
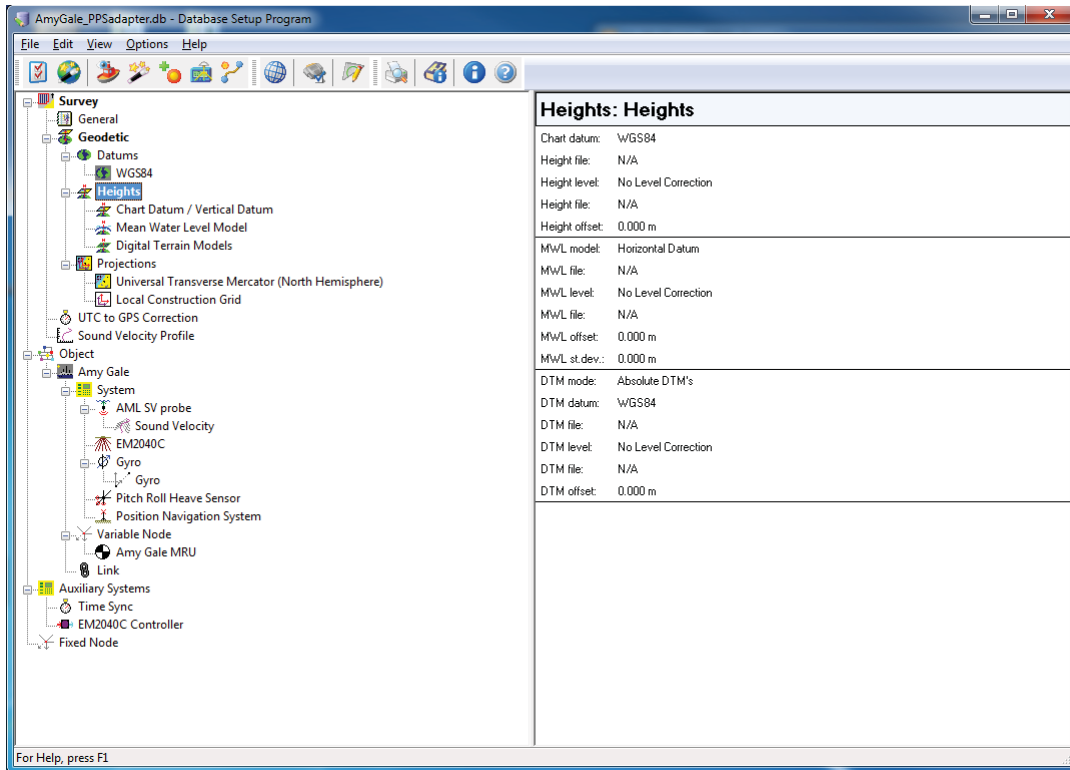

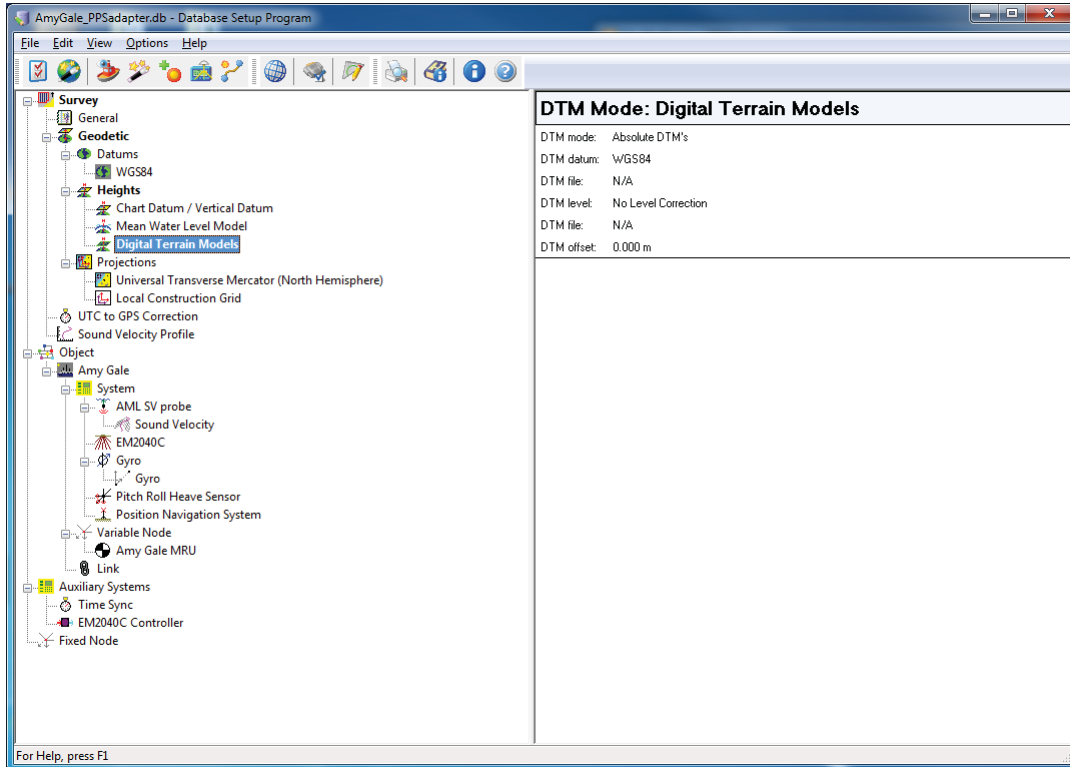
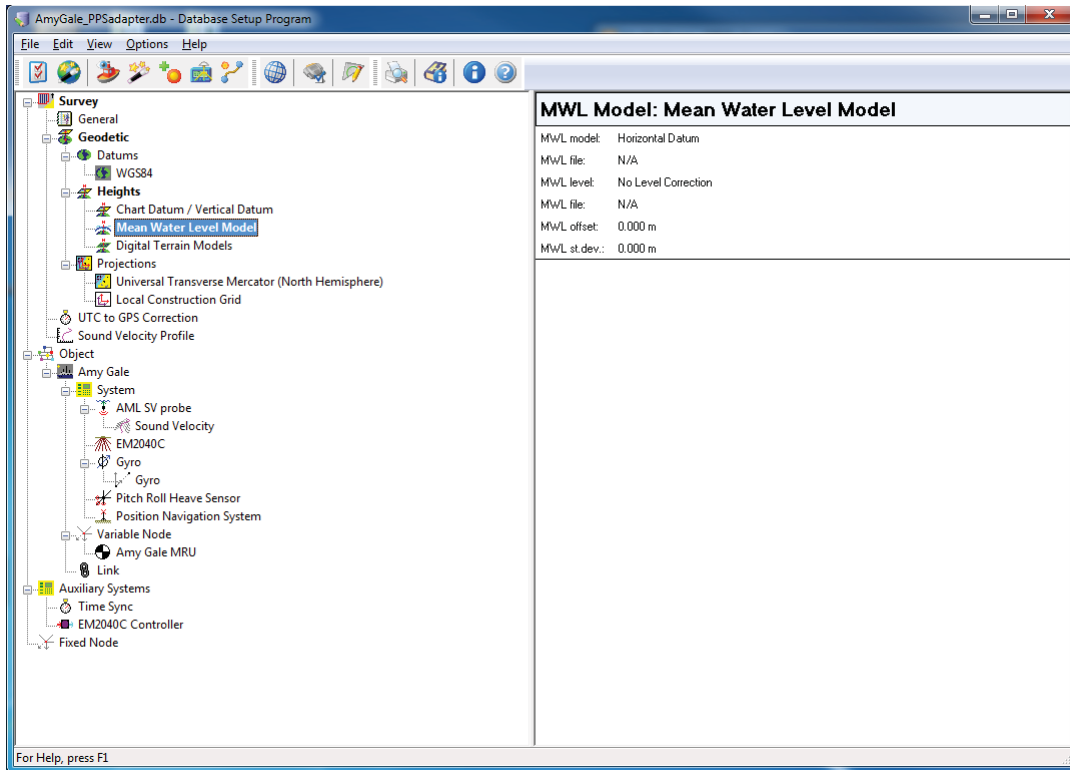

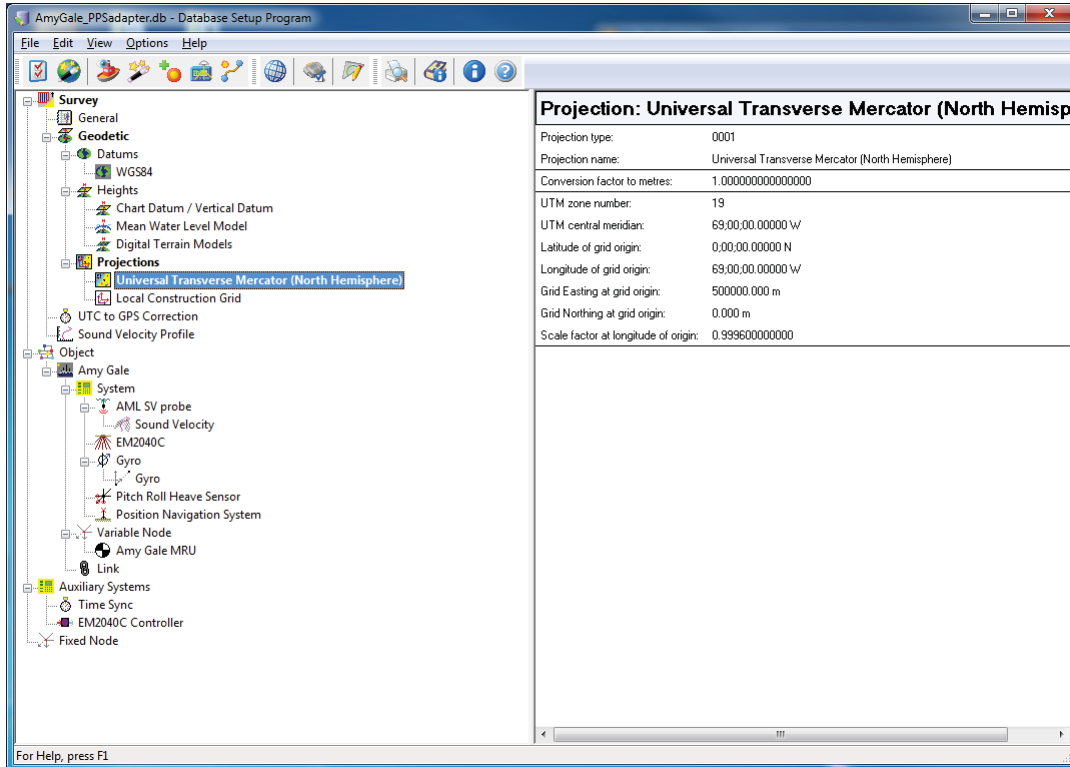
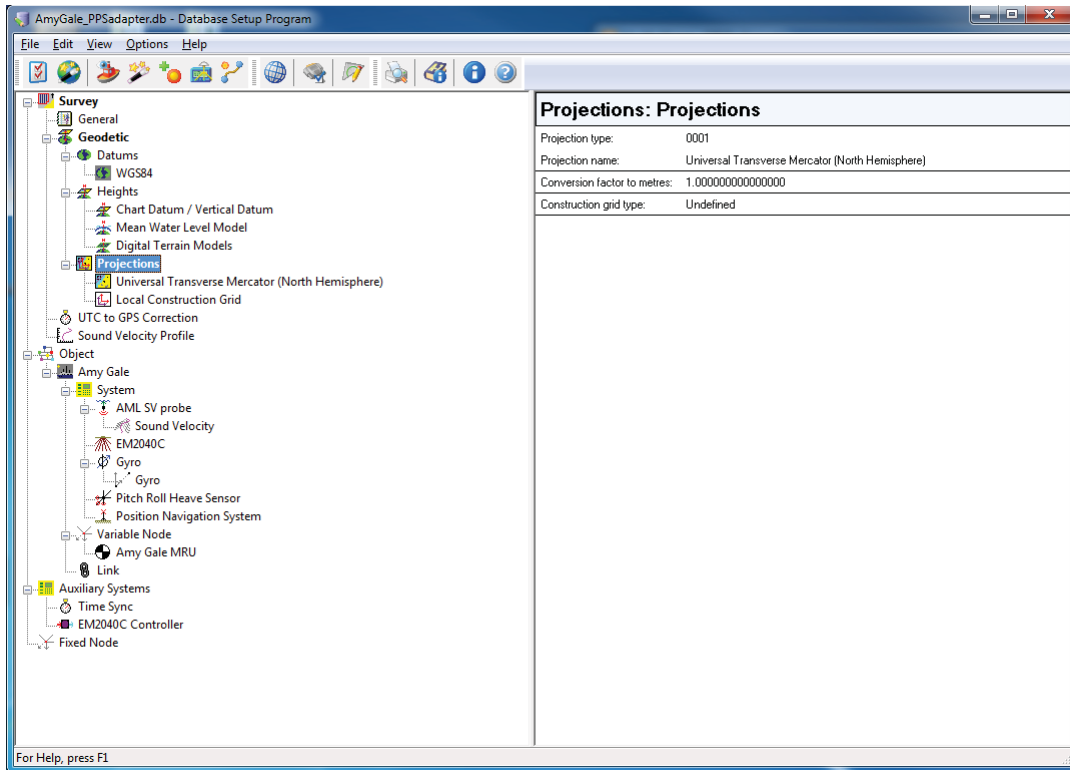

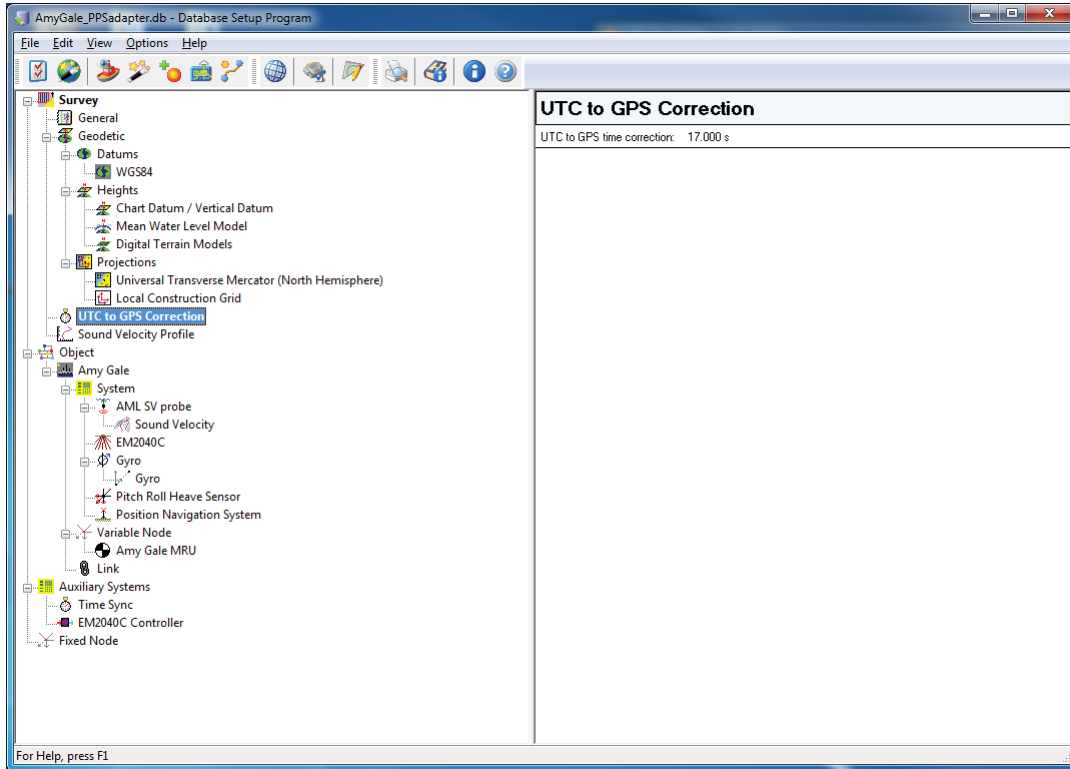
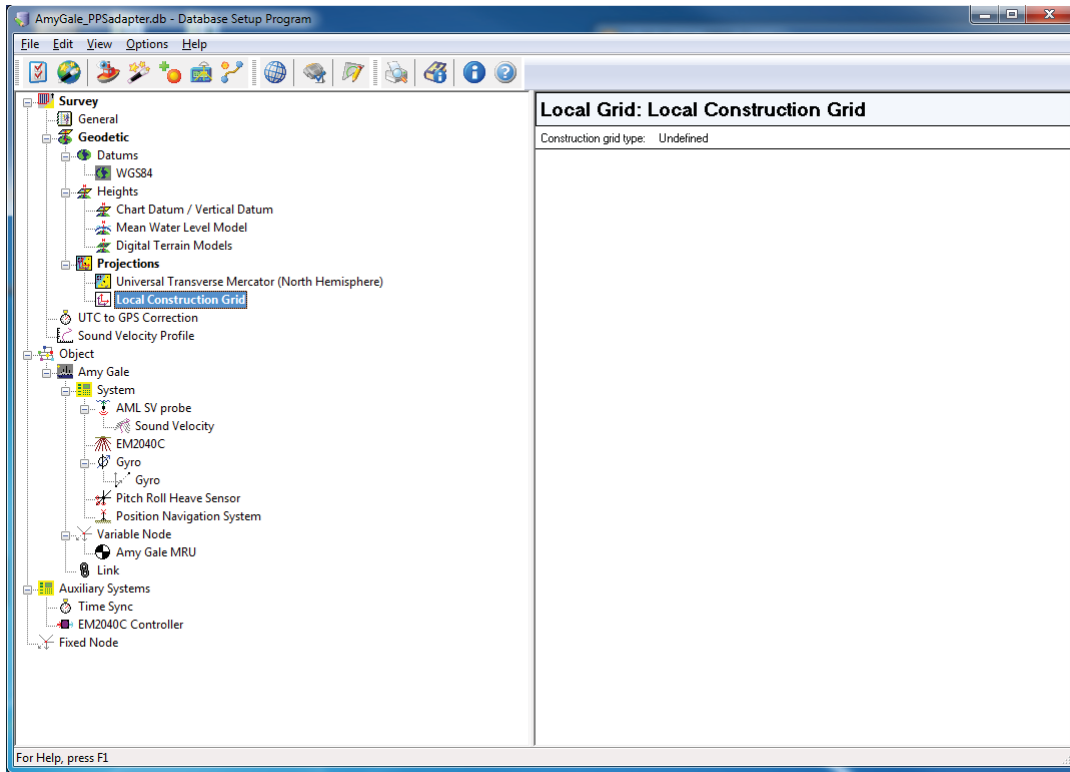

AmyGale_PPSadapter.db - Database Setup Program

File Edit View Options Help

Survey

- General
- Geodetic
 - Datums
 - WGS84
 - Heights
 - Chart Datum / Vertical Datum
 - Mean Water Level Model
 - Digital Terrain Models
 - Projections
 - Universal Transverse Mercator (North Hemisphere)
 - Local Construction Grid
 - UTC to GPS Correction
 - Sound Velocity Profile**
- Object
 - Amy Gale
 - System
 - AML SV probe
 - Sound Velocity
 - EM2040C
 - Gyro
 - Gyro
 - Pitch Roll Heave Sensor
 - Position Navigation System
 - Variable Node
 - Amy Gale MRU
 - Link
 - Auxiliary Systems
 - Time Sync
 - EM2040C Controller
 - Fixed Node

Sound Velocity Profile

Profile ID:	440
Profile latitude:	43.4356.87840 N
Profile longitude:	69.3720.29622 W
Profile date:	2015-11-18
Profile time:	13:50
Depth unit:	Meters
Velocity unit:	Meters / Second
SD depth data:	0.100 m
SD velocity data:	0.050 m/s
Number of entries:	40

For Help, press F1

AmyGale_2016_1.db - Database Setup Program

File Edit View Options Help

Survey

- General
- Geodetic
 - Datums
 - WGS84
 - Heights
 - Chart Datum / Vertical Datum
 - Mean Water Level Model
 - Digital Terrain Models
 - Projections
 - Universal Transverse Mercator (North Hemisphere)
 - Local Construction Grid
 - UTC to GPS Correction
 - Sound Velocity Profile
- Object
 - Amy Gale**
 - System
 - AML SV probe
 - Sound Velocity
 - EM2040C
 - Gyro
 - Gyro
 - Pitch Roll Heave Sensor
 - Position Navigation System
 - Variable Node
 - Amy Gale MRU
 - RX
 - TX
 - Link
 - Auxiliary Systems
 - Time Sync
 - EM2040C Controller
 - Fixed Node

Object: Amy Gale

Object reference number:	1
Object type:	Vessel
Description of reference point:	Amy Gale MRU
Height above draft reference:	0.000 m
Squat model:	Not Defined
SD draft:	0.050 m
SD squat:	0.050 m
SD load:	0.050 m
SD tide:	0.100 m
Time latency navigation:	0.025 s
Time correction to GMT (UTC):	0.000 h
Time correction to master vessel's time:	0.000 s

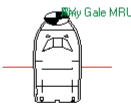

For Help, press F1

AmyGale_PPSadapter.db - Database Setup Program

File Edit View Options Help

Survey

- General
- Geodetic
 - Datums
 - WGS84
 - Heights
 - Chart Datum / Vertical Datum
 - Mean Water Level Model
 - Digital Terrain Models
 - Projections
 - Universal Transverse Mercator (North Hemisphere)
 - Local Construction Grid
 - UTC to GPS Correction
 - Sound Velocity Profile
- Object
 - Amy Gale
 - System
 - AML SV probe**
 - Sound Velocity
 - EM2040C
 - Gyro
 - Gyro
 - Pitch Roll Heave Sensor
 - Position Navigation System
 - Variable Node
 - Amy Gale MRU
 - Link
 - Auxiliary Systems
 - Time Sync
 - EM2040C Controller
 - Fixed Node

System: AML SV probe

Description:	AML SV probe
Type:	Underwater Sensor
Driver:	Sound Velocity - Smart SV (AML, ASCII) (Active)
Executable and Cmdline:	DrvSoundVelocity.exe ACT
Port:	5
Baud rate:	9600
Data bits:	8
Stop bits:	1
Parity:	None
Byte frame length (time):	10 bits (1.042 ms)
Maximum data transfer rate:	960 bytes / second
Update rate:	0.000 s
Latency:	0.000 s
Acquired by:	[Directly into QINSy] (No additional time tags)
Observation time from:	N/A
Number of slots:	0

For Help, press F1

AmyGale_PPSadapter.db - Database Setup Program

File Edit View Options Help

Survey

- General
- Geodetic
 - Datums
 - WGS84
 - Heights
 - Chart Datum / Vertical Datum
 - Mean Water Level Model
 - Digital Terrain Models
 - Projections
 - Universal Transverse Mercator (North Hemisphere)
 - Local Construction Grid
 - UTC to GPS Correction
 - Sound Velocity Profile
- Object
 - Amy Gale
 - System
 - AML SV probe
 - Sound Velocity**
 - EM2040C
 - Gyro
 - Gyro
 - Pitch Roll Heave Sensor
 - Position Navigation System
 - Variable Node
 - Amy Gale MRU
 - Link
 - Auxiliary Systems
 - Time Sync
 - EM2040C Controller
 - Fixed Node

Observation: Sound Velocity

Observation description:	Sound Velocity
Observation type:	Sound Velocity
'A1' node:	Amy Gale MRU
Measurement unit code:	Meters / Second
System description:	AML SV probe
[C-O] option:	[C-O] offsets applied first
Scale factor:	1.000000000000
Fixed system [C-O]:	0.0000000000
Variable [C-O]:	0.00000000
A-priori SD:	0.0500

For Help, press F1

AmyGale_2016_1ldb - Database Setup Program

File Edit View Options Help

System: EM2040C

Description: EM2040C
 Type: Multibeam Echosounder
 Driver: Kongsberg EM2040/EM710/EM302/EM122
 Executable and Endpoint: D:\KongsbergEM.exe
 Driver specific settings: RAW_BATHY=1,RAW_SNP=1,RAW_WCD=1:
 Port: 2001
 Update rate: 0.000 s
 Acquired by: [Directly into QINSy] (No additional time tags)
 Observation time from: N/A
 Number of slots: 1
 Manufacturer: Unknown
 Model: Unknown
 Object location: Amy Gale
 Node name: TX - TX
 X (Sbtd = Positive): 0.040 m
 Y (Bow = Positive): 0.004 m
 Z (Up = Positive): 0.006 m
 Apriori SD: 0.010 m
 Object location: Amy Gale
 Node name: RX - RX
 X (Sbtd = Positive): 0.000 m
 Y (Bow = Positive): -0.045 m
 Z (Up = Positive): 0.006 m
 Apriori SD: 0.010 m
 Roll offset: TX: 0.190 , RX: 0.190
 Pitch offset: TX: 0.890 , RX: 0.890
 Heading offset: TX: -0.400 , RX: -0.400
 Unit is roll stabilized: No
 Unit is pitch stabilized: No
 Unit is heave compensated: No
 Beam steering (flat transducer): No
 Beam angle width along: 1.500 m
 Beam angle width across: 1.500 m
 Maximum number of beams per ping: 800
 Use sound velocity from unit: Yes
 Slot: 1
 Sound velocity for beam angle: Sound Velocity
 SD type: Pulse, Sampling

For Help, press F1

AmyGale_2016_1ldb - Database Setup Program

File Edit View Options Help

Observation time from: N/A
 Number of slots: 1
 Manufacturer: Unknown
 Model: Unknown
 Object location: Amy Gale
 Node name: TX - TX
 X (Sbtd = Positive): 0.040 m
 Y (Bow = Positive): 0.004 m
 Z (Up = Positive): 0.006 m
 Apriori SD: 0.010 m
 Object location: Amy Gale
 Node name: RX - RX
 X (Sbtd = Positive): 0.000 m
 Y (Bow = Positive): -0.045 m
 Z (Up = Positive): 0.006 m
 Apriori SD: 0.010 m
 Roll offset: TX: 0.190 , RX: 0.190
 Pitch offset: TX: 0.890 , RX: 0.890
 Heading offset: TX: -0.400 , RX: -0.400
 Unit is roll stabilized: No
 Unit is pitch stabilized: No
 Unit is heave compensated: No
 Beam steering (flat transducer): No
 Beam angle width along: 1.500 m
 Beam angle width across: 1.500 m
 Maximum number of beams per ping: 800
 Use sound velocity from unit: Yes
 Slot: 1
 Sound velocity for beam angle: Sound Velocity
 SD type: Pulse, Sampling
 SD pulse length: 0.150 ms
 SD sampling length: 0.050 m
 SD roll offset: 0.050 °
 SD pitch offset: 0.050 °
 SD heading offset: 0.500 °
 SD roll stabilization: 0.000 °
 SD pitch stabilization: 0.000 °
 SD heave compensation: 0.000 m
 SD sound velocity: 0.050 m/s

For Help, press F1

AmyGale_PPSadapter.db - Database Setup Program

File Edit View Options Help

Survey

- General
- Geodetic
 - Datums
 - WGS84
 - Heights
 - Chart Datum / Vertical Datum
 - Mean Water Level Model
 - Digital Terrain Models
 - Projections
 - Universal Transverse Mercator (North Hemisphere)
 - Local Construction Grid
 - UTC to GPS Correction
 - Sound Velocity Profile
- Object
 - Amy Gale
 - System
 - AML SV probe
 - Sound Velocity
 - EM2040C
 - Gyro
 - Pitch Roll Heave Sensor
 - Position Navigation System
 - Variable Node
 - Amy Gale MRU
 - Link
 - Auxiliary Systems
 - Time Sync
 - EM2040C Controller
 - Fixed Node

System: Gyro

Description:	Gyro
Type:	Gyro Compass
Driver:	Network - Seapath Binary Format 11 (Hdg) (With UTC)
Executable and Cmdline:	DrvQPSCountedJDP.exe SEAPATH_FMT11 PPS
Port:	13001
Update rate:	0.000 s
Latency:	0.000 s
Acquired by:	[Directly into QINSy] [No additional time tags]
Observation time from:	N/A
Number of slots:	0

For Help, press F1

AmyGale_PPSadapter.db - Database Setup Program

File Edit View Options Help

Survey

- General
- Geodetic
 - Datums
 - WGS84
 - Heights
 - Chart Datum / Vertical Datum
 - Mean Water Level Model
 - Digital Terrain Models
 - Projections
 - Universal Transverse Mercator (North Hemisphere)
 - Local Construction Grid
 - UTC to GPS Correction
 - Sound Velocity Profile
- Object
 - Amy Gale
 - System
 - AML SV probe
 - Sound Velocity
 - EM2040C
 - Gyro
 - Pitch Roll Heave Sensor
 - Position Navigation System
 - Variable Node
 - Amy Gale MRU
 - Link
 - Auxiliary Systems
 - Time Sync
 - EM2040C Controller
 - Fixed Node

Observation: Gyro

Observation description:	Gyro
Observation type:	Bearing (True)
'A1' node:	Amy Gale MRU
Measurement unit code:	Degrees
System description:	Gyro
[C-O] option:	[C-O] offsets applied first
Scale factor:	1.000000000000
Fixed system [C-O]:	0.0000000000
Variable [C-O]:	0.0000000000
A-priori SD:	0.5000

For Help, press F1

AmyGale_PPSadapter.db - Database Setup Program

File Edit View Options Help

Survey

- General
- Geodetic
 - Datums
 - WGS84
 - Heights
 - Chart Datum / Vertical Datum
 - Mean Water Level Model
 - Digital Terrain Models
 - Projections
 - Universal Transverse Mercator (North Hemisphere)
 - Local Construction Grid
 - UTC to GPS Correction
 - Sound Velocity Profile
- Object
 - Amy Gale
 - System
 - AML SV probe
 - Sound Velocity
 - EM2040C
 - Gyro
 - Gyro
 - Pitch Roll Heave Sensor**
 - Position Navigation System
 - Variable Node
 - Amy Gale MRU
 - Link
 - Auxiliary Systems
 - Time Sync
 - EM2040C Controller
 - Fixed Node

System: Pitch Roll Heave Sensor

Description:	Pitch Roll Heave Sensor
Type:	Pitch Roll Heave Sensor
Driver:	Network - Seapath MRU Binary Format 11 (With UTC)
Executable and Cmdline:	DrvQPSCountedUDP.exe SEAPATH_FMT11 PPS
Port:	13001
Update rate:	0.000 s
Latency:	0.000 s
Acquired by:	[Directly into QINSy] (No additional time tags)
Observation time from:	N/A
Number of slots:	0
Object:	Amy Gale
PRH sensor reference number:	1
Rotation convention pitch:	Positive bow up
Rotation convention roll:	Positive heeling to starboard
Angular variable measured:	HPR (roll first)
Angular measurement units:	Degrees
Sign convention heave:	Positive upwards
Measurement units heave:	Meters
Conversion factor to degrees decimal:	N/A
Conversion factor to metres:	N/A
Quality indicator type pitch and roll:	No quality info recorded
Quality indicator type heave:	No quality info recorded
Description of quality indicator type:	
Object location:	Amy Gale
Node name:	Amy Gale MRU
X (Stbd = Positive):	0.000 m
Y (Bow = Positive):	0.000 m
Z (Up = Positive):	0.000 m

For Help, press F1

AmyGale_PPSadapter.db - Database Setup Program

File Edit View Options Help

Survey

- General
- Geodetic
 - Datums
 - WGS84
 - Heights
 - Chart Datum / Vertical Datum
 - Mean Water Level Model
 - Digital Terrain Models
 - Projections
 - Universal Transverse Mercator (North Hemisphere)
 - Local Construction Grid
 - UTC to GPS Correction
 - Sound Velocity Profile
- Object
 - Amy Gale
 - System
 - AML SV probe
 - Sound Velocity
 - EM2040C
 - Gyro
 - Gyro
 - Pitch Roll Heave Sensor**
 - Position Navigation System
 - Variable Node
 - Amy Gale MRU
 - Link
 - Auxiliary Systems
 - Time Sync
 - EM2040C Controller
 - Fixed Node

PRH sensor reference number: 1

Rotation convention pitch:	Positive bow up
Rotation convention roll:	Positive heeling to starboard
Angular variable measured:	HPR (roll first)
Angular measurement units:	Degrees
Sign convention heave:	Positive upwards
Measurement units heave:	Meters
Conversion factor to degrees decimal:	N/A
Conversion factor to metres:	N/A
Quality indicator type pitch and roll:	No quality info recorded
Quality indicator type heave:	No quality info recorded
Description of quality indicator type:	
Object location:	Amy Gale
Node name:	Amy Gale MRU
X (Stbd = Positive):	0.000 m
Y (Bow = Positive):	0.000 m
Z (Up = Positive):	0.000 m
A-priori SD:	0.000 m
[C-0] roll offset:	0.000 °
[C-0] pitch offset:	0.000 °
[C-0] heave offset:	0.000 m
Heave time delay:	0.000 s
Heave filter length:	N/A
SD roll and pitch:	0.050 °
SD heave (fixed):	0.050 m
SD heave (variable):	5.000 %
SD roll offset:	0.050 °
SD pitch offset:	0.050 °
SD heave offset:	0.050 m

For Help, press F1

AmyGale_PPSadapter.db - Database Setup Program

File Edit View Options Help

Survey

- General
- Geodetic
 - Datums
 - WGS84
 - Heights
 - Chart Datum / Vertical Datum
 - Mean Water Level Model
 - Digital Terrain Models
 - Projections
 - Universal Transverse Mercator (North Hemisphere)
 - Local Construction Grid
 - UTC to GPS Correction
 - Sound Velocity Profile
- Object
 - Amy Gale**
 - System**
 - AML SV probe
 - Sound Velocity
 - EM2040C
 - Gyro
 - Gyro
 - Pitch Roll Heave Sensor
 - Position Navigation System**
 - Variable Node
 - Amy Gale MRU
 - Link
 - Auxiliary Systems
 - Time Sync
 - EM2040C Controller
 - Fixed Node

System: Position Navigation System

Description:	Position Navigation System
Type:	Position Navigation System
Driver:	Network - Seapath Binary Format 11 (With UTC)
Executable and Cmdline:	DrvQPSCountedJDP.exe SEAPATH_FMT11 PPS
Port:	13001
Update rate:	0.000 s
Latency:	0.000 s
Acquired by:	[Directly into QINSy] (No additional time tags)
Observation time from:	N/A
Number of slots:	0
Horizontal datum:	1
Satellite system:	4
Satellite system name:	WGS84
Horizontal datum:	WGS84
Vertical datum:	WGS84
Height file:	N/A
Height level:	No Level Correction
Height file:	N/A
Height offset:	0.000 m
SD latitude:	0.500 m
SD longitude:	0.500 m
SD height:	1.000 m
Receiver number:	0
Slot:	0
Object location:	Amy Gale
Node name:	Amy Gale MRU
X (Stbd = Positive):	0.000 m
Y (Bow = Positive):	0.000 m

For Help, press F1

AmyGale_PPSadapter.db - Database Setup Program

File Edit View Options Help

Survey

- General
- Geodetic
 - Datums
 - WGS84
 - Heights
 - Chart Datum / Vertical Datum
 - Mean Water Level Model
 - Digital Terrain Models
 - Projections
 - Universal Transverse Mercator (North Hemisphere)
 - Local Construction Grid
 - UTC to GPS Correction
 - Sound Velocity Profile
- Object
 - Amy Gale**
 - System**
 - AML SV probe
 - Sound Velocity
 - EM2040C
 - Gyro
 - Gyro
 - Pitch Roll Heave Sensor
 - Position Navigation System**
 - Variable Node
 - Amy Gale MRU
 - Link
 - Auxiliary Systems
 - Time Sync
 - EM2040C Controller
 - Fixed Node

System: Position Navigation System

Type:	Position Navigation System
Driver:	Network - Seapath Binary Format 11 (With UTC)
Executable and Cmdline:	DrvQPSCountedJDP.exe SEAPATH_FMT11 PPS
Port:	13001
Update rate:	0.000 s
Latency:	0.000 s
Acquired by:	[Directly into QINSy] (No additional time tags)
Observation time from:	N/A
Number of slots:	0
Horizontal datum:	1
Satellite system:	4
Satellite system name:	WGS84
Horizontal datum:	WGS84
Vertical datum:	WGS84
Height file:	N/A
Height level:	No Level Correction
Height file:	N/A
Height offset:	0.000 m
SD latitude:	0.500 m
SD longitude:	0.500 m
SD height:	1.000 m
Receiver number:	0
Slot:	0
Object location:	Amy Gale
Node name:	Amy Gale MRU
X (Stbd = Positive):	0.000 m
Y (Bow = Positive):	0.000 m
Z (Up = Positive):	0.000 m
A-priori SD:	0.000 m

For Help, press F1

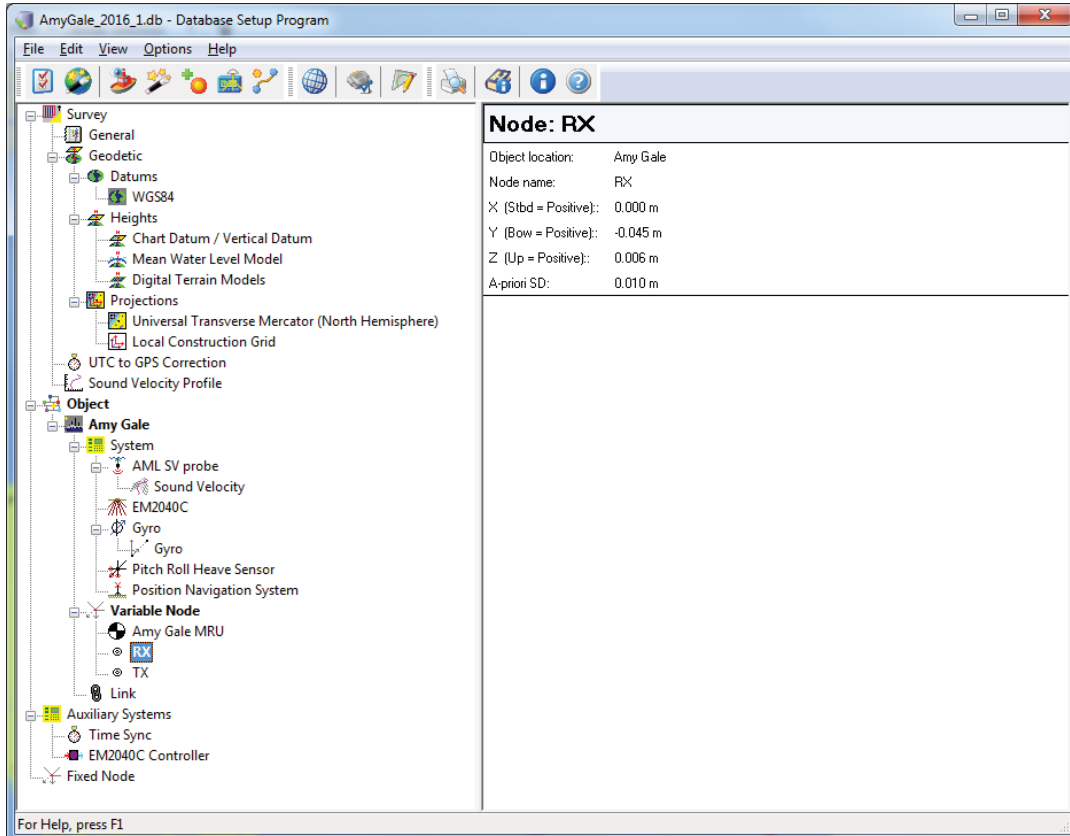
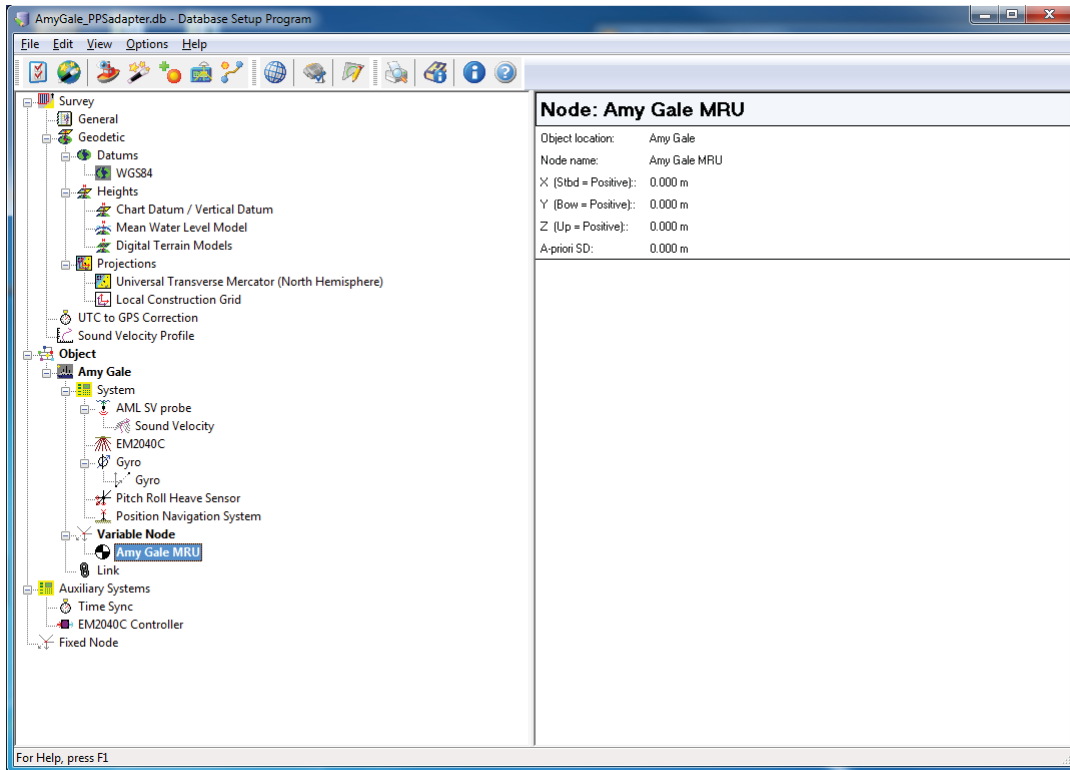

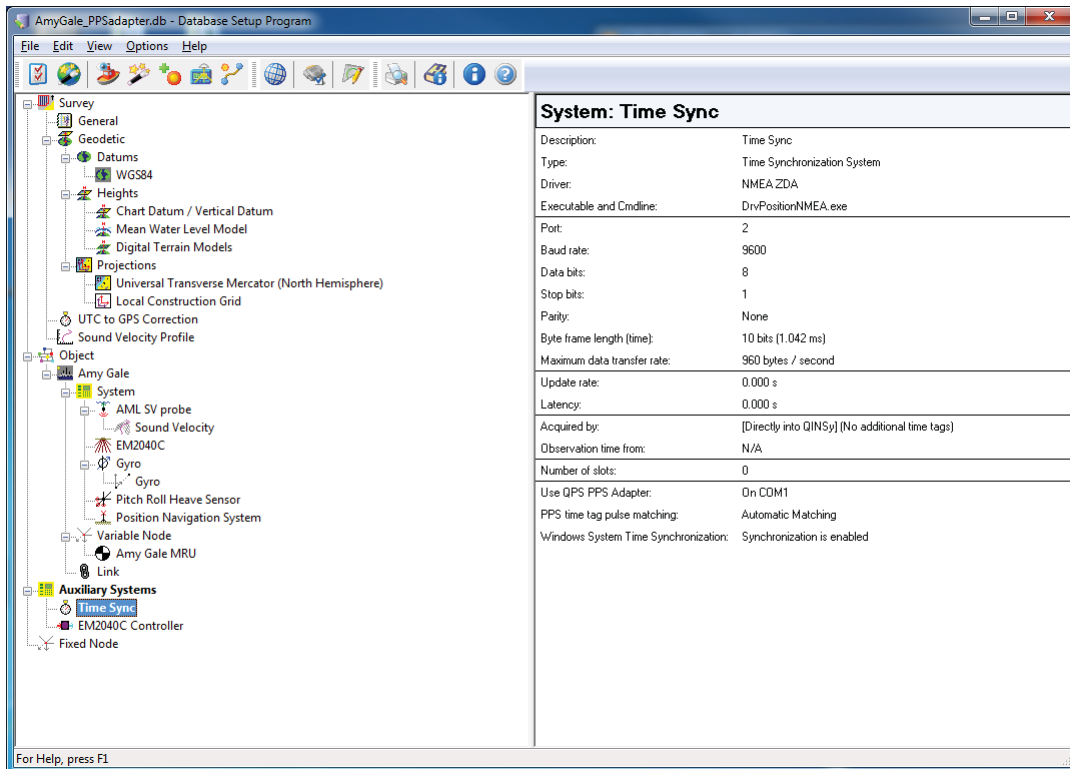
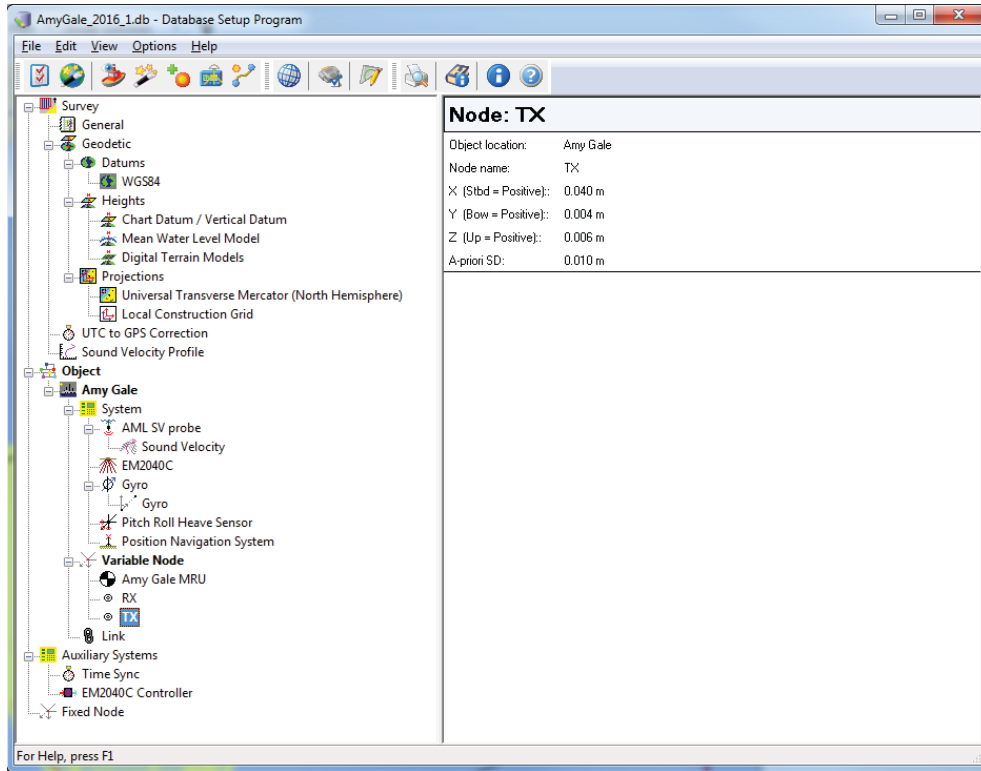

AmyGale_PPSadapter.db - Database Setup Program

File Edit View Options Help

System: EM2040C Controller

Description:	EM2040C Controller
Type:	Miscellaneous System
Driver:	Kongsberg EM2040 Compact (Single) Multibeam Controller
Executable and Cmdline:	DrvKongsbergEMCtrl.exe 2040C
Update rate:	0.000 s
Latency:	0.000 s
Acquired by:	[Directly into QINSy] (No additional time tags)
Observation time from:	N/A
Number of slots:	0

For Help, press F1

The screenshot shows a software interface for configuring a database system. The left pane is a tree view with the following structure:

- Survey
 - General
 - Geodetic
 - Datums
 - WGS84
 - Heights
 - Chart Datum / Vertical Datum
 - Mean Water Level Model
 - Digital Terrain Models
 - Projections
 - Universal Transverse Mercator (North Hemisphere)
 - Local Construction Grid
 - UTC to GPS Correction
 - Sound Velocity Profile
 - Object
 - Amy Gale
 - System
 - AML SV probe
 - Sound Velocity
 - EM2040C
 - Gyro
 - Gyro
 - Pitch Roll Heave Sensor
 - Position Navigation System
 - Variable Node
 - Amy Gale MRU
 - Link
 - Auxiliary Systems
 - Time Sync
 - EM2040C Controller
 - Fixed Node

Appendix D – Configuration settings for EM2040C shown in QINSy EM controller

EM Controller - EM2040C Controller

PU Status

Status	Active
Pinging	28848 @ 33.60 Hz
Clock Status	Ok
Errors	All Ok

Buttons: Stop, Pu Info, Options...

Settings

Transmit Angle (deg)	0.0
Minimum Depth	1.00
Maximum Depth	500.00
Detector Mode	Normal
Slope Filter	On
Aeration Filter	Off
Interference Filter	Off
Range Gate Size	Normal
Spike Filter Strength	Medium
Phase Ramp	Normal
Special Amp Detect	Off
Special TVG	Off
Normal Inci. Sector Angle	10
Ping Mode	300 KHz
Pulse Type	Auto
Transmit Power Level	Maximum
FM Enable	FM Enabled
3D Scanning - Scan Step	0.0
3D Scanning - Min Angle	-5
3D Scanning - Max Angle	5
Dual Swath Mode	Off
Min. Swath Distance	0.0
Yaw Stabilization Mode	Off
Yaw Manual Angle	0.0
Heading Filter	Medium

Buttons: Apply, Settings..., Force..., Log Events

Events

```

11:02:11.135 Connection to PU Established
11:02:11.135 Set Initial Settings
11:02:11.405 Command Accepted
11:05:39.685 New Sound Velocity (1476.6 m/s)
    
```

Options

PU Setup

System Type (from DbSetup)	EM2040C Single Transducer
Pu Ip Address	157.237.20.40
Simulation Mode	Off
External Triggering	Off
Control Port	2000
Enabled Output Ports	Output Port 1,2,3
Output Port 1 (Bathy)	2001
Output Port 2 (Bathy)	2002
Output Port 3 (Sidescan)	2003
ZDA/GGA Serial Port	Port 1 (default)
Use GGA	On
Baudrate ZDA/GGA	9600
Motion Serial Port	Port 2 (default)

Program Options

Start Pinging when QINSy Starts	Pinging On Startup
Synchronize Clock Interval(min.)	60
Sound Velocity Mode	From SoundVelocity C
Sound Velocity Observation	Sound Velocity
Popup window when error occurs	On
Allow HD beamspaceing with Water Column Data	Not Allowed

Installation Parameters

RX1 Gain Offet	0
RX2 Gain Offet	0
Head1 Installation angles from	EM2040C
Head2 Installation angles from	Not Used
Velocity Sensor Number	Motion Sensor 1
Velocity Sensor UDP Port	3001
Velocity Sensor Ethernet Port	Ethernet Port 2 (if available)
Ethernet Port 2 IP Address	192.168.1.1
Ethernet Port 2 IP Mask	255.255.0.0

OK Cancel

Appendix E – Mainscheme crossline surface difference test files, results, and plots

File List

Reference Surface: MCMI_mainscheme_2016_4m_MLLW.sd

Crosslines:

Sonar File: 0001_112125_083016_Amy_Gale_xline - 0001.db
Sonar File: 0002_112954_083016_Amy_Gale_xline - 0001.db
Sonar File: 0003_113708_083016_Amy_Gale_xline - 0001.db
Sonar File: 0004_115132_083016_Amy_Gale_xline - 0001.db
Sonar File: 0005_120420_083016_Amy_Gale_xline - 0001.db
Sonar File: 0005_120503_083016_Amy_Gale_xline - 0002.db
Sonar File: 0005_120859_083016_Amy_Gale_xline - 0003.db
Sonar File: 0006_121949_083016_Amy_Gale_xline - 0001.db
Sonar File: 0007_124026_083016_Amy_Gale_xline - 0001.db
Sonar File: 0008_125442_083016_Amy_Gale_xline - 0001.db
Sonar File: 0009_131105_083016_Amy_Gale_xline - 0001.db
Sonar File: 0010_132821_083016_Amy_Gale_xline - 0001.db
Sonar File: 0011_135603_083016_Amy_Gale_xline - 0001.db
Sonar File: 0011_141531_083016_Amy_Gale_xline - 0002.db
Sonar File: 0012_142901_083016_Amy_Gale_xline - 0001.db
Sonar File: 0013_145314_083016_Amy_Gale_xline - 0001.db
Sonar File: 0014_151851_083016_Amy_Gale_xline - 0001.db
Sonar File: 0014_154756_083016_Amy_Gale_xline - 0002.db
Sonar File: 0015_155954_083016_Amy_Gale_xline - 0001.db
Sonar File: 0016_163419_083016_Amy_Gale_xline - 0001.db
Sonar File: 0016_163853_083016_Amy_Gale_xline - 0002.db
Sonar File: 0016_164237_083016_Amy_Gale_xline - 0003.db
Sonar File: 0017_170057_083016_Amy_Gale_xline - 0001.db
Sonar File: 0017_170813_083016_Amy_Gale_xline - 0002.db
Sonar File: 0018_173514_083016_Amy_Gale_xline - 0001.db
Sonar File: 0019_114700_083116_Amy_Gale_xline - 0001.db
Sonar File: 0020_123050_083116_Amy_Gale_xline - 0001.db
Sonar File: 0020_123312_083116_Amy_Gale_xline - 0002.db
Sonar File: 0021_125349_083116_Amy_Gale_xline - 0001.db
Sonar File: 0022_131616_083116_Amy_Gale_xline - 0001.db
Sonar File: 0023_134430_083116_Amy_Gale_xline - 0001.db
Sonar File: 0023_141422_083116_Amy_Gale_xline - 0002.db
Sonar File: 0024_143202_083116_Amy_Gale_xline - 0001.db
Sonar File: 0024_145231_083116_Amy_Gale_xline - 0002.db

Sonar File: 0025_114731_090116_Amy_Gale_xline - 0001.db
 Sonar File: 0026_120816_090116_Amy_Gale_xline - 0001.db
 Sonar File: 0027_124258_090116_Amy_Gale_xline - 0001.db
 Sonar File: 0028_130819_090116_Amy_Gale_xline - 0001.db
 Sonar File: 0028_132157_090116_Amy_Gale_xline - 0002.db
 Sonar File: 0029_135940_090116_Amy_Gale_xline - 0001.db
 Sonar File: 0029_143538_090116_Amy_Gale_xline - 0002.db
 Sonar File: 0030_152205_090116_Amy_Gale_xline - 0001.db
 Sonar File: 0030_153838_090116_Amy_Gale_xline - 0002.db
 Sonar File: 0031_155721_090116_Amy_Gale_xline - 0001.db
 Sonar File: 0031_160039_090116_Amy_Gale_xline - 0002.db
 Sonar File: 0031_161014_090116_Amy_Gale_xline - 0003.db
 Sonar File: 0032_164229_090116_Amy_Gale_xline - 0001.db
 Sonar File: 0033_170200_090116_Amy_Gale_xline - 0001.db
 Sonar File: 0034_125858_090216_Amy_Gale_xline - 0001.db
 Sonar File: 0035_133837_090216_Amy_Gale_xline - 0001.db
 Sonar File: 0036_140208_090216_Amy_Gale_xline - 0001.db
 Sonar File: 0036_141642_090216_Amy_Gale_xline - 0002.db
 Sonar File: 0037_143845_090216_Amy_Gale_xline - 0001.db
 Sonar File: 0038_145439_090216_Amy_Gale_xline - 0001.db
 Sonar File: 0038_151049_090216_Amy_Gale_xline - 0002.db
 Sonar File: 0038_153652_090216_Amy_Gale_xline - 0003.db
 Sonar File: 0038_154353_090216_Amy_Gale_xline - 0004.db

Summary Stats

# of Points of Comparison	48899424
Data Mean	-34.288084
Reference Mean	-34.254108
Mean	0.033976
Median	0.338406
Std. Deviation	0.253795
Data Z - Range	-135.83 to -3.59
Ref. Z - Range	-158.06 to -2.02
Diff Z - Range	-22.80 to 23.48
Mean + 2*stddev	0.541566
Median + 2*stddev	0.845996
Ord 1 Error Limit	0.500692
Ord 1 P-Statistic	0.029038
Ord 1 - # Rejected	1419919
Order 1 Survey	ACCEPTED

Plots (histogram, scatter, and uncertainty)

Key for plots:

- Gray dots represent difference in depth between the crossline and the reference surface for individual beam angles or beam numbers
- Purple areas represent the 95% confidence interval (2 standard deviations) based on normal distribution (see histogram)
- Yellow dashed lines represent limit of IHO Order 1 test vertical tolerance
- Gray dashed lines on histogram represent \pm sigma 1, 2, and 3
- Blue lines represent the mean value

Histogram

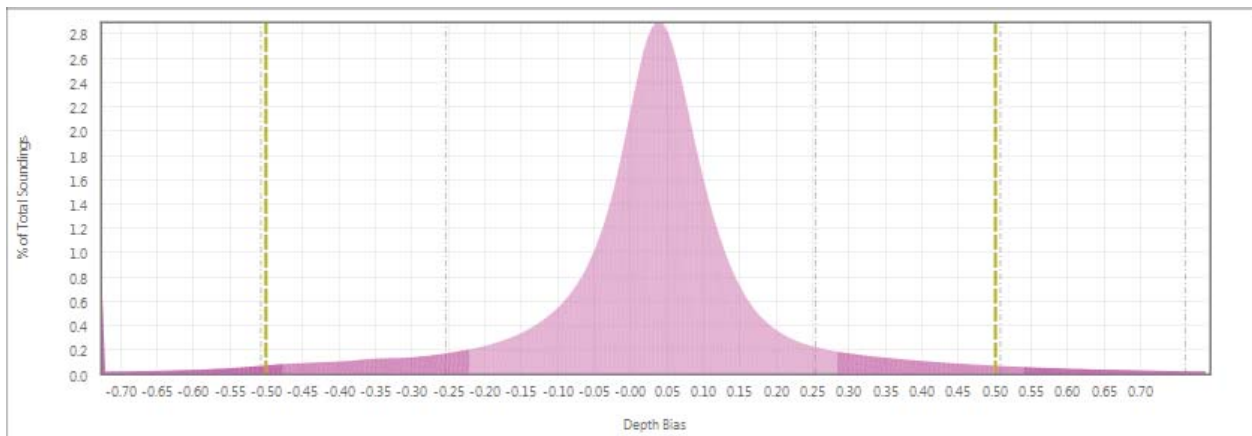

Scatter Plots

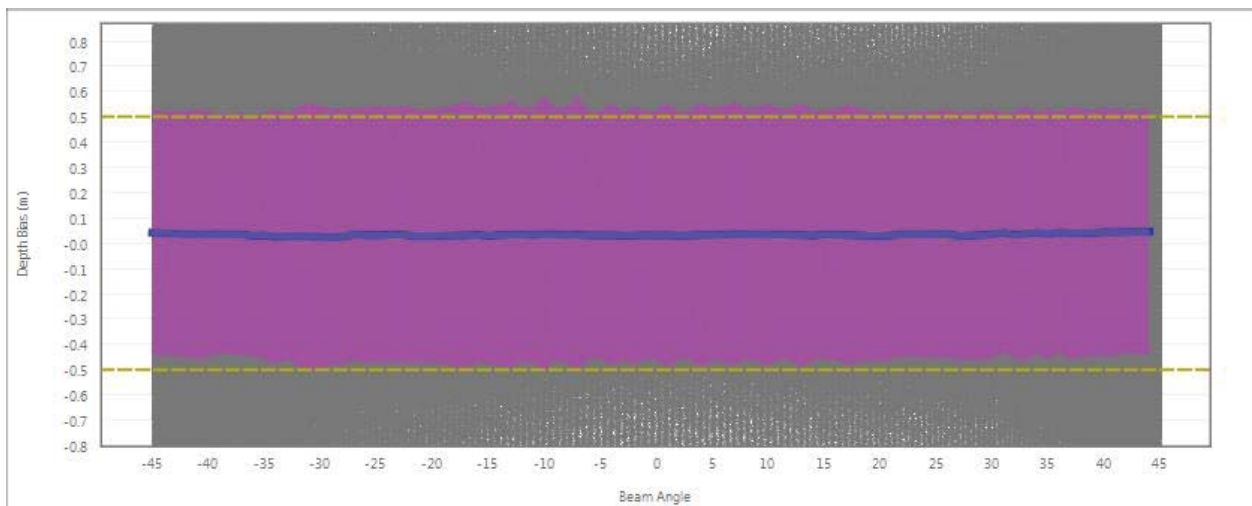

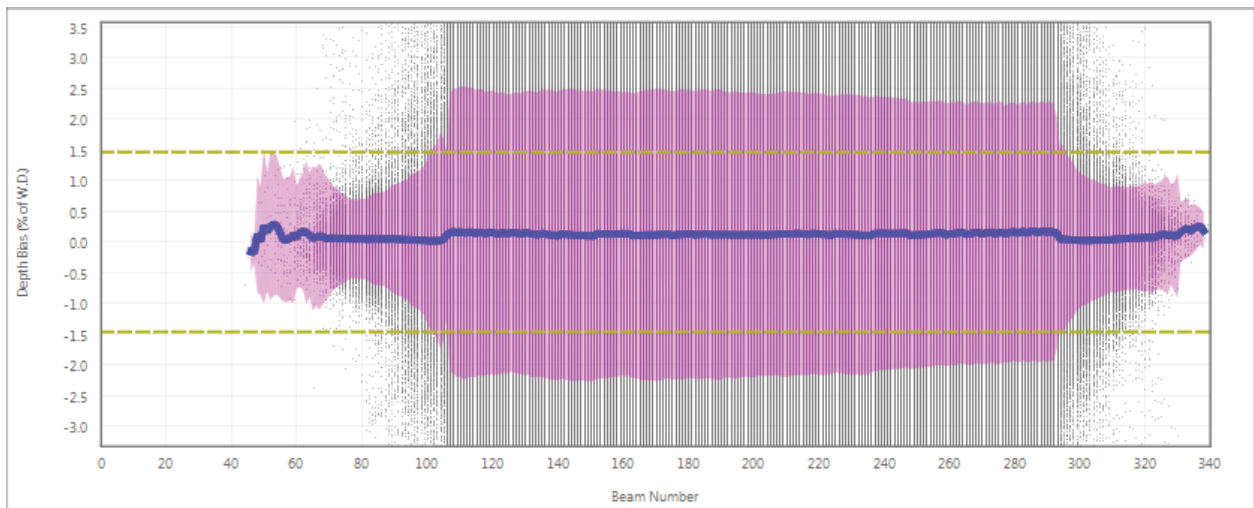
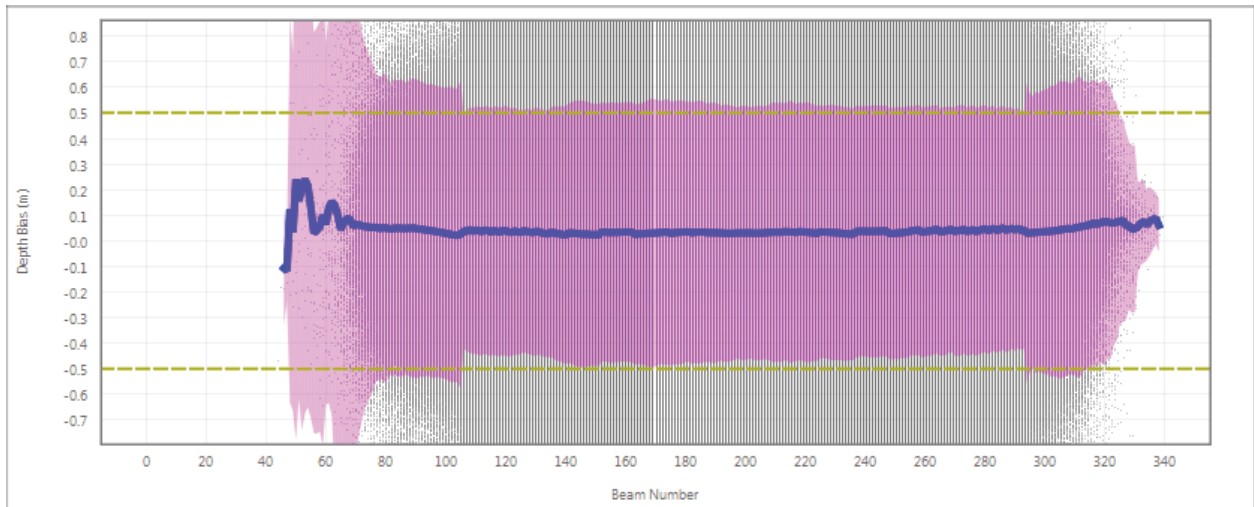
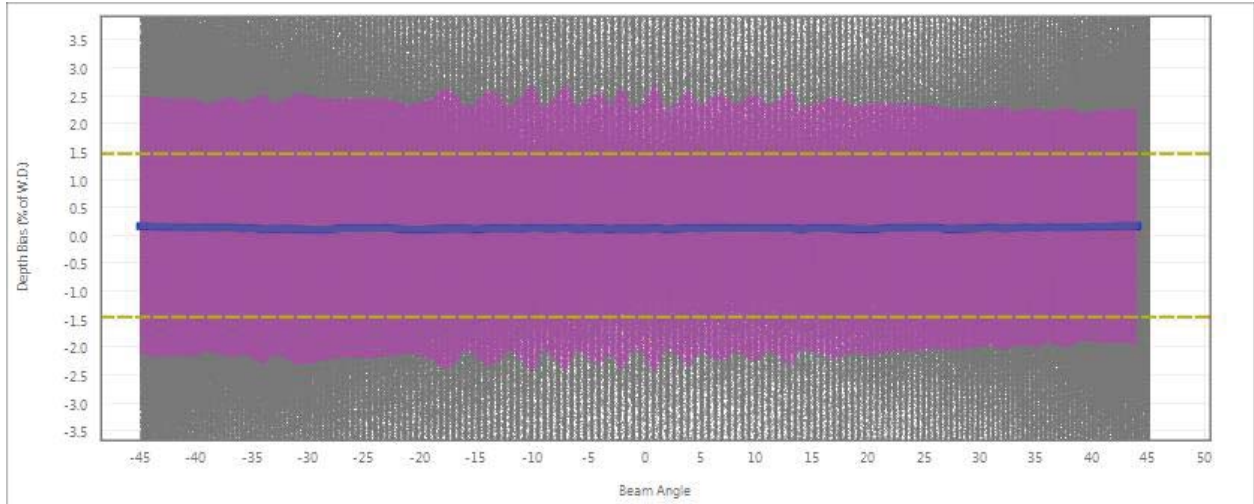

Uncertainty Plots

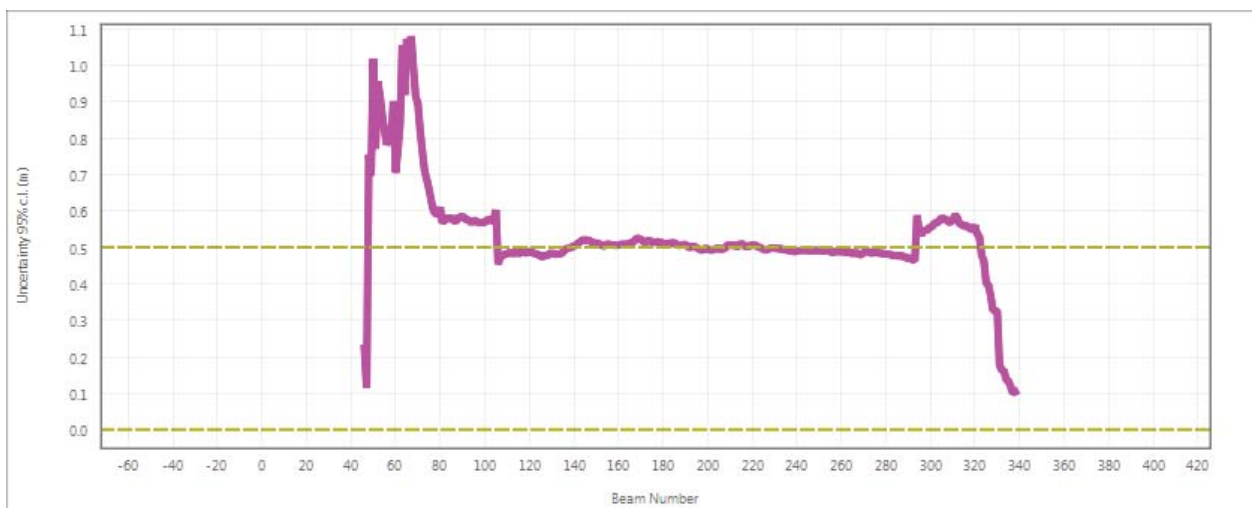
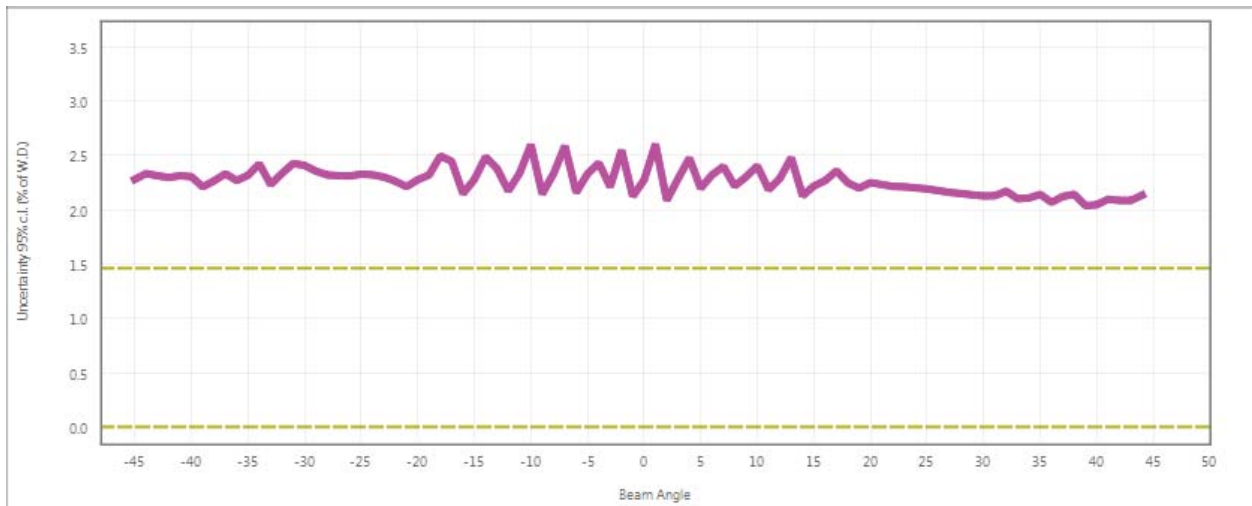
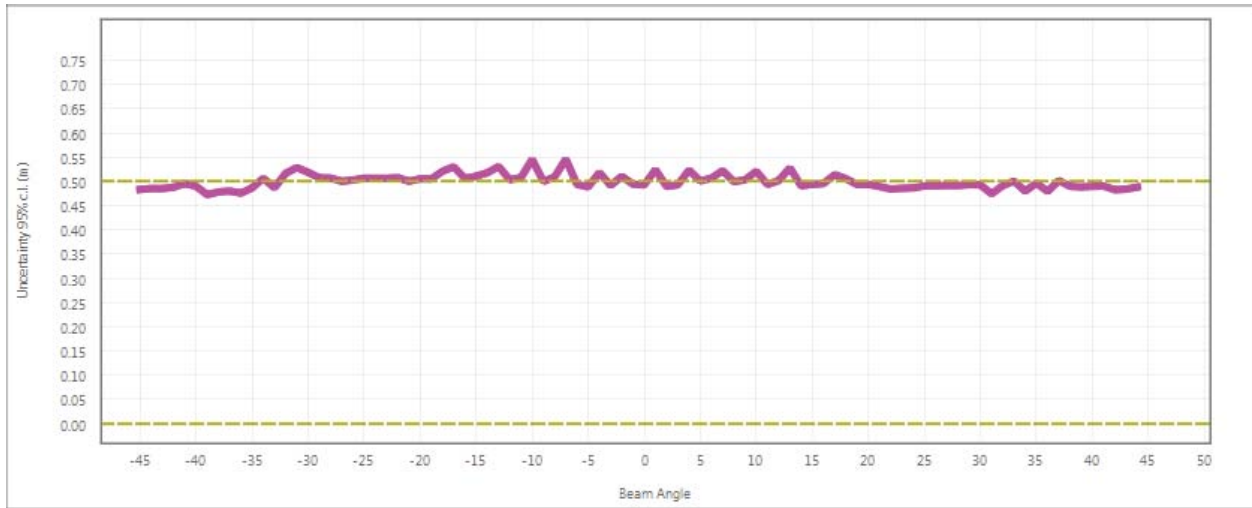

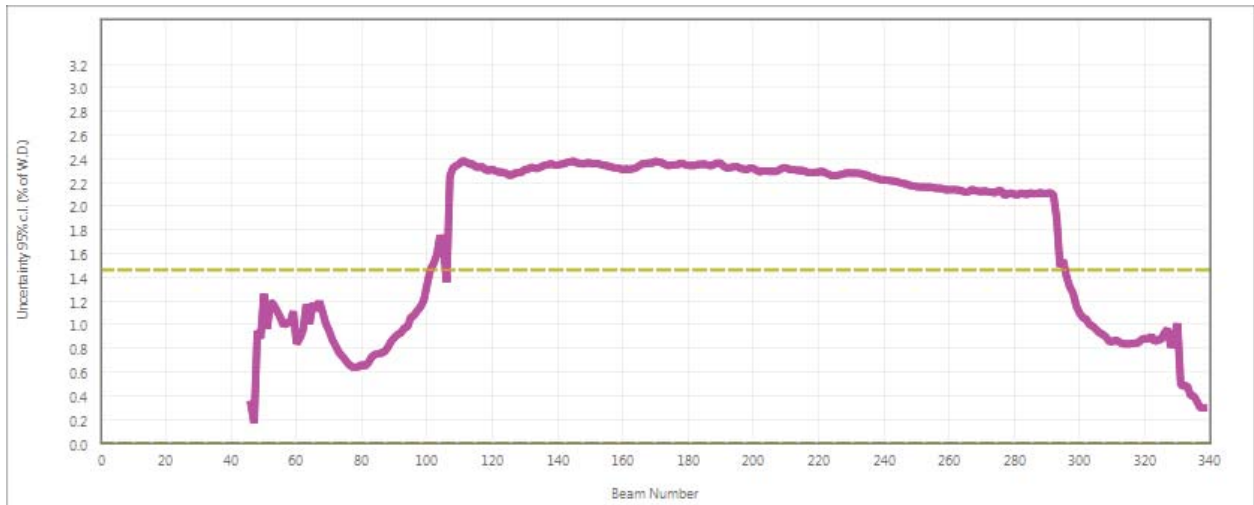

Appendix F – Explanation and details related to vertical offset/inshore post-processing issue

This appendix contains a full explanation and details related to the discovery of the issues with raw sonar file 0052_165504_042916_Townsend_Gut-0001.db (referred to in the following as line 0052), corrective actions to be taken by QPS support technicians, and the interim steps taken as a work-around to ensure incorporation of the data into the final surface.

The initial discovery of this issue became apparent during post-processing and when viewing the initial dynamic surface created from raw sonar files (.db format; acquired with QINSy v.8.12) acquired (on April 29, 2016) during inshore surveying in Townsend Gut area of Southport, Maine, where the navigation (survey trackline) for line 0052 appeared as a truncated version (Figure F1) of the original file. The result of this truncation was an incomplete surface containing many holidays that were coincident with the original survey trackline. This was immediately identified as an error associated with the processed .qpd file for line 0052 because a preliminary processing session (performed several days after completing the survey within Townsend Gut) contained a complete surface with no evidence of erroneous data (Figure F2).

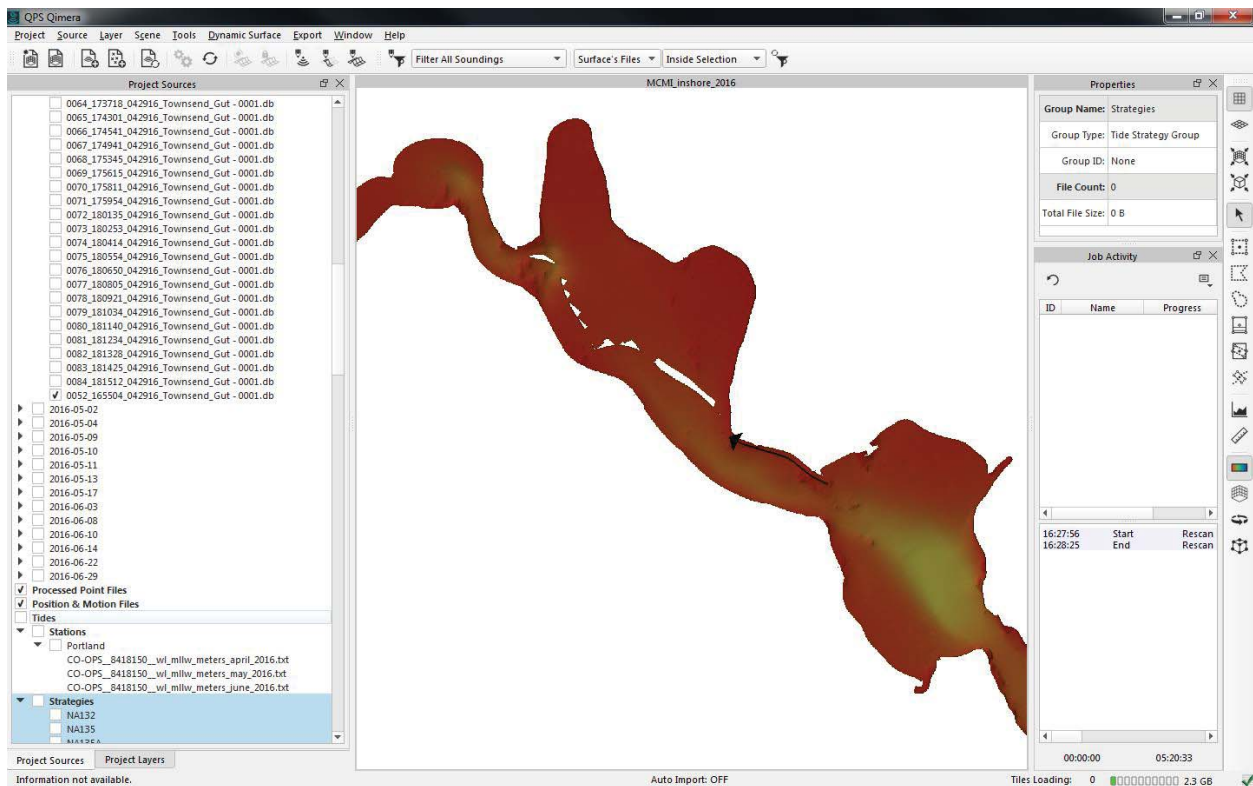

Figure F1. Incomplete dynamic surface resulting from incomplete extraction of data associated with line 0052 (black arrow). This surface was created from .qpd files created from raw sonar files (.db format) in Qimera v.1.3.6.

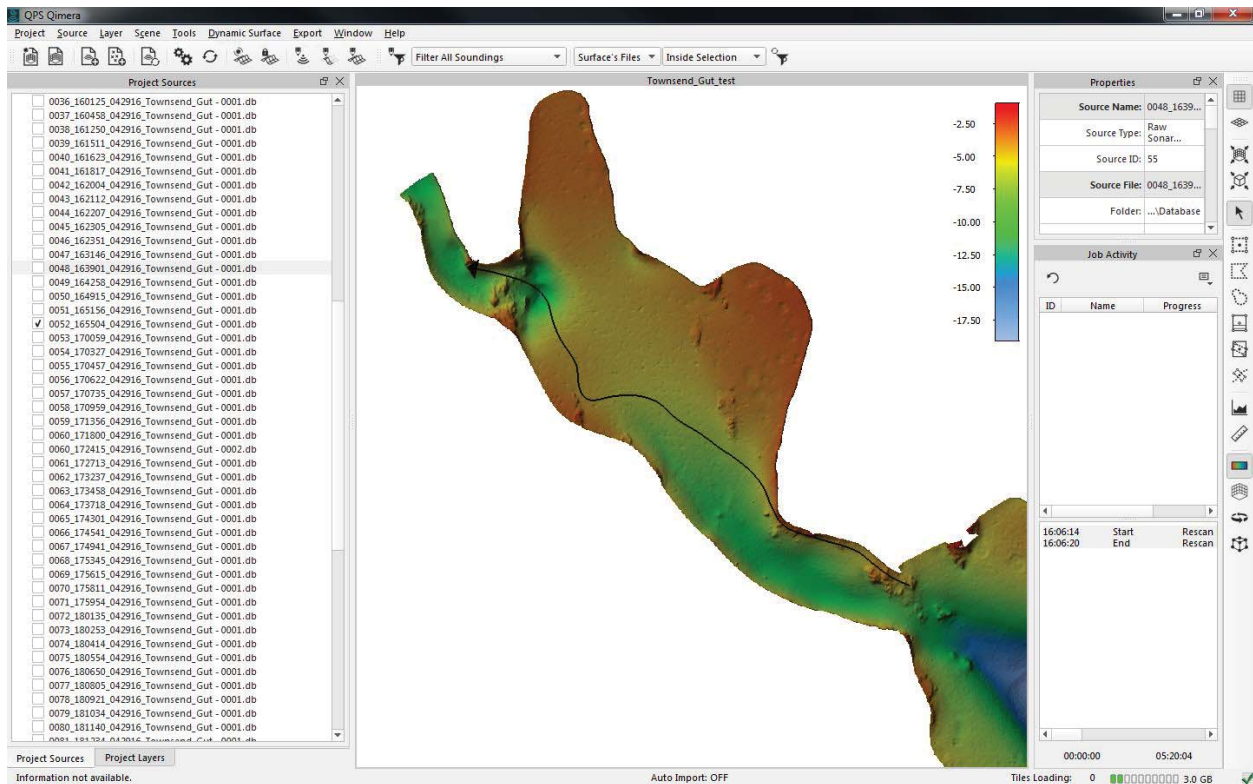

Figure F2. Complete dynamic surface resulting from incomplete extraction of data associated with line 0052 (black arrow). In contrast to the surface shown in Figure F1, this surface was created from matching pre-existing .qpj files (created in QINSy v.8.12 during acquisition) with raw sonar files (.db format) in Qimera v.1.3.6.

The 0.5-meter surfaces shown in Figures F1 and F2 were created in separate Qimera projects. The main difference between these surfaces was that the surface in F1 was created from processed .qpj files newly generated within the Qimera project from raw sonar source files (.db format), whereas the surface in F2 was created from processed .qpj files that were created from source files that were matched with pre-existing (created during acquisition in QINSy) .qpj files upon import in to the Qimera project. Each 0.5-meter surface was exported from Qimera as an .sd object and a surface difference test was performed in Fledermaus v.7.7.0. The result of this test revealed a virtually uniform vertically offset equal to the draft value across the entire surface. Summary statistics from this test are shown in Table F1. Subsequent surface difference tests with adjacent surfaces (e.g. 2015 inshore surface) confirmed that the surface created from matched .qpj files was in fact erroneous, and that the offset was also equal to draft. As a result of these observations, two issues became apparent: (1) there is an issue with the raw sonar file for line 0052 and (2) Qimera is not applying values entered for draft when creating surfaces for source files (.db format) matched with pre-existing .qpj file upon import. These issues were promptly brought to the attention of QPS support engineers via JIRA support tickets (JIRA ticket ID numbers SQL-18439 and SQM-1579).

QPS support engineers were able to reproduce these issues and have noted the following as of 12-14-2016: The issue related to the inability of Qimera to incorporate draft values for surface created from source files with matched .qpj files has been recognized as an issue to be addressed in future release versions of the software. The issue related to the erroneous values and the unexplained truncation of line 0052 when not matched with pre-existing .qpj file is currently under investigation.

Table F1. Surface difference results: surface created from new qpds vs. surface created from matched qpds.

Surface Characteristics Information	
Name:	QR0_MCMI_townsend_gut_2016_50cm_MLLW_matched_qpd_surface_TownsendGut_50cm
Dimensions:	3264 rows x 2784 columns
Cell Size:	0.500000
Bounds:	
X Range:	446265.2 to 447656.8
Y Range:	4854173.2 to 4855804.8
Z Range:	-6.15 to 2.58
Horizontal Coordinate System:	
FP_WGS_84_UTM_zone_19N	
Surface Statistics Information	
Name:	QR0_MCMI_townsend_gut_2016_50cm_MLLW_matched_qpd_surface_TownsendGut_50cm
Median:	-0.85
Mean:	-0.85
Std Dev:	0.07
Height Range:	[-6.152, 2.577]
Total 2D Surface Area:	374235.00
Positive (above 0.0) 2D Surface Area:	182.50
Negative (below 0.0) 2D Surface Area:	374052.00
Total Volume:	-318529.77
Positive (above 0.0) Volume:	63.80
Negative (below 0.0) Volume:	318593.57

Since Qimera had/has no problems incorporating draft values for surfaces created from newly generated .qpd files, the only issue that needed immediate action was how to deal with the missing data for line 0052. Thus, an interim work-around for this issue was developed by the hydrographer to meet previously established goals related to the timeline in which the post-processing of 2016 data was completed. This work-around procedure is explained below.

First, all inshore survey raw sonar files except for line 0052 were imported in to the Qimera project. Qimera then generated new .qpd files for these files. The raw sonar file for line 0052 was then imported separately and matched with the original .qpd file that was created during acquisition. As a result, all data associated with line 0052 were vertically offset by 0.85 meters (0.85 meters shallower than the surrounding surface; see (a) in Figure F3). To compensate for this offset, a static offset equal to the draft (0.85 meters) was applied to the data in the erroneous file, which resulted in a vertical match with the adjacent survey data (see (b) in Figure F3). This work-around did not affect any results related to junction survey analyses. Any further corrective action for this issue is pending the results of the investigation by QPS.

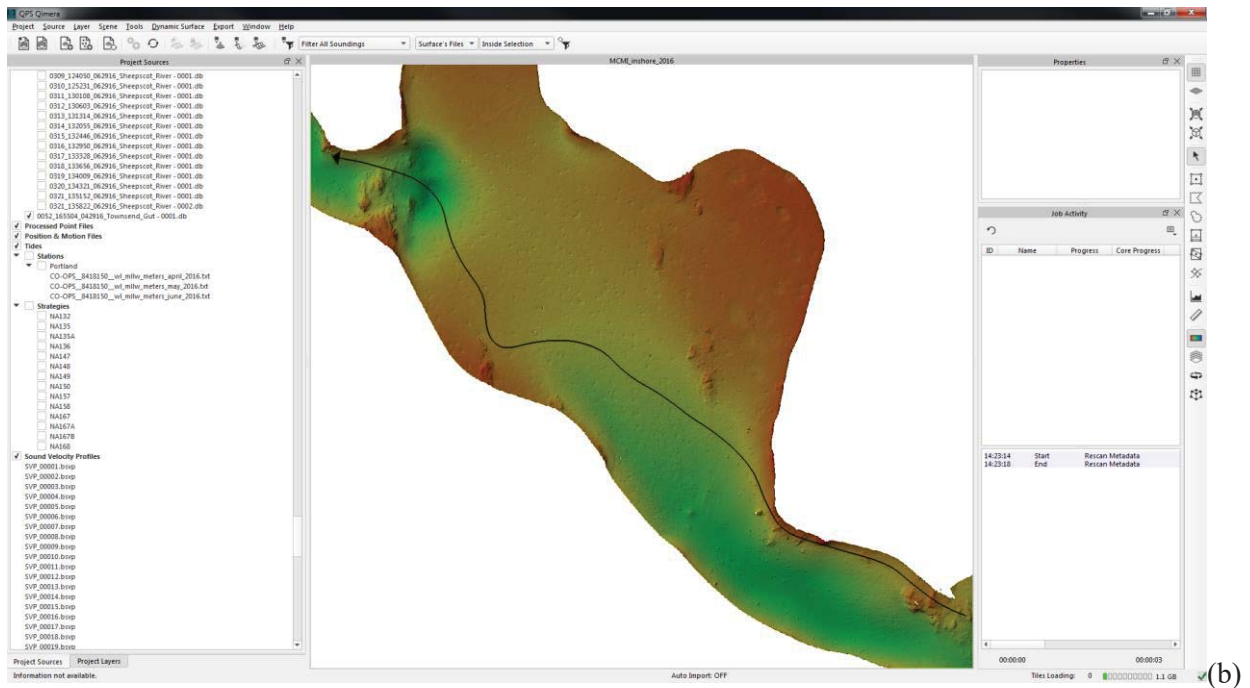
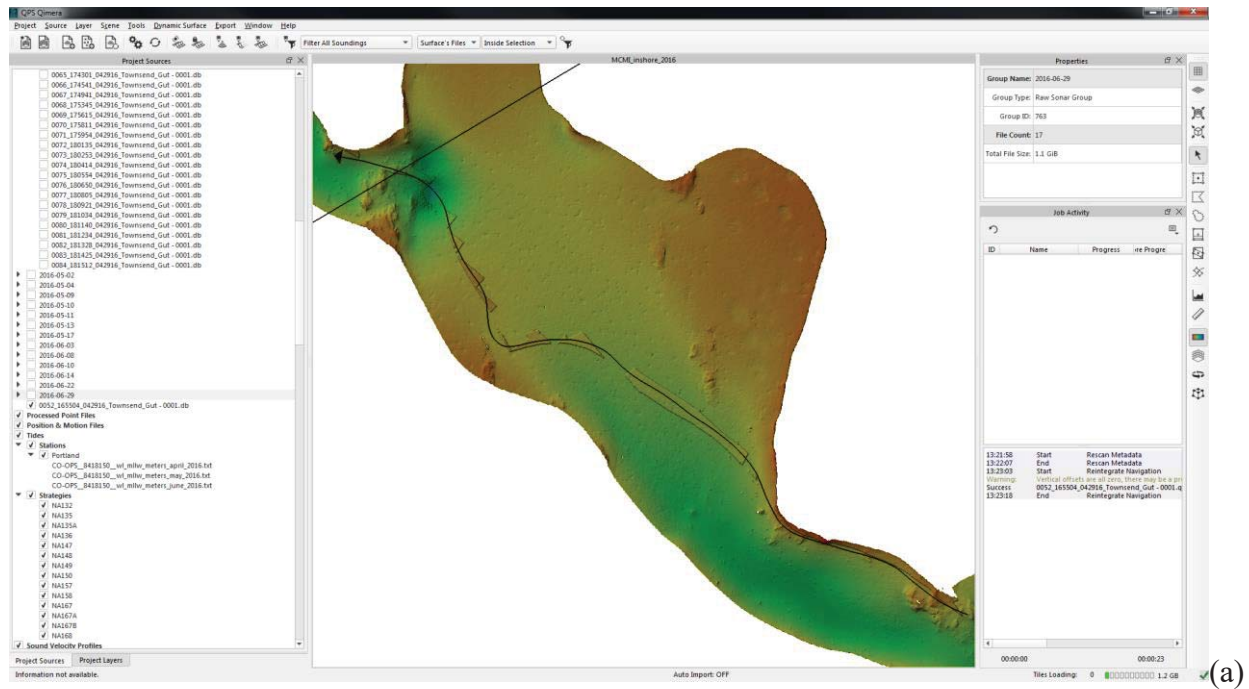

Figure F3. Surfaces showing (a) before and (b) after applying static offset equal to draft (0.85 meters) to line 0052.

Appendix G – Seafloor anomalies

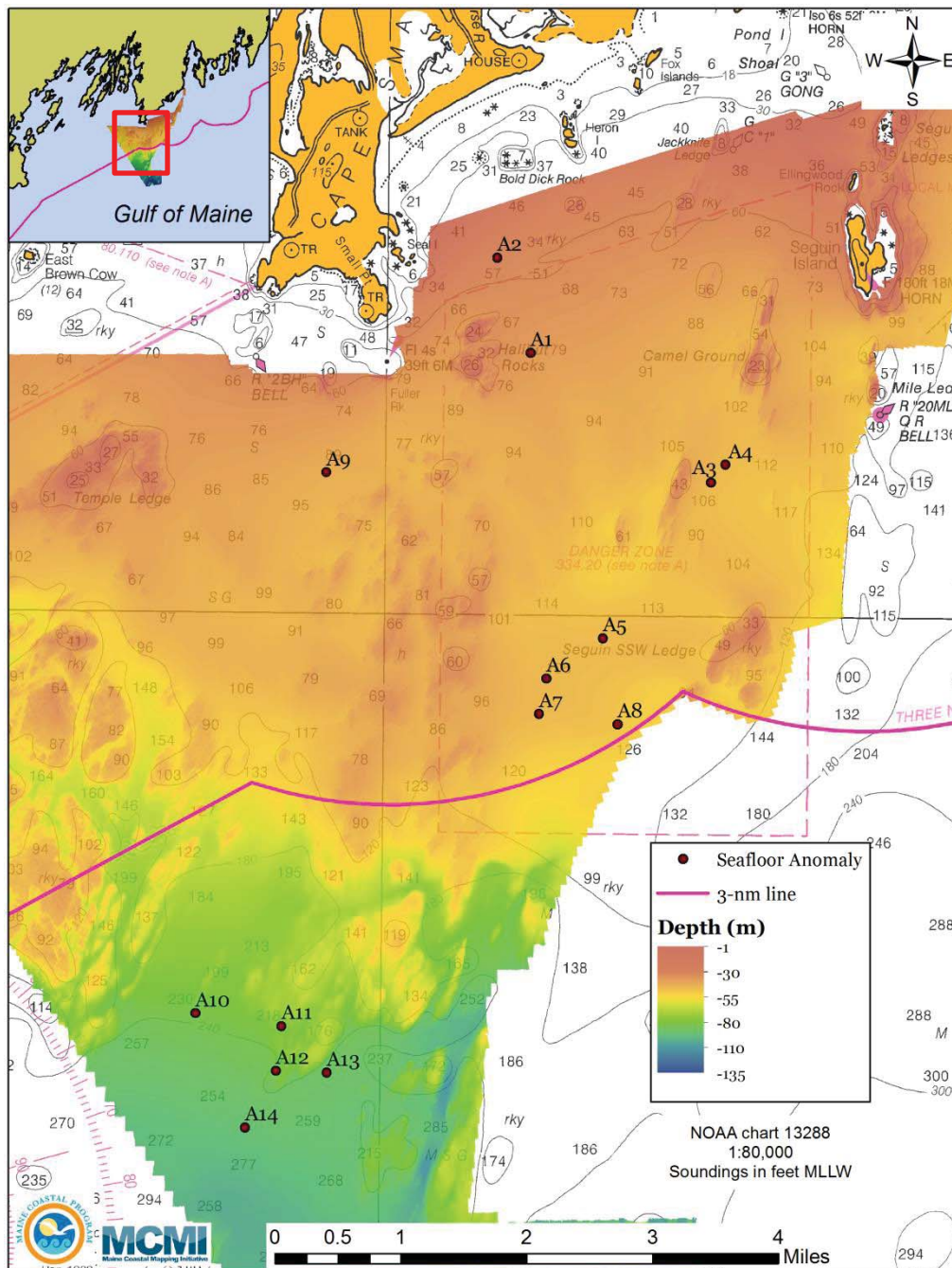

Figure G1. MCM main scheme 2016 survey area seafloor anomalies. Transparent bathymetry (4-meter grid) overlain on NOAA chart 13288. Anomalies A1 and A3 through A8 lie within bounds of danger zone noted on chart. See Table G1 for anomaly coordinates and attributes.

Table G1. Seafloor anomaly attributes

ID	Easting (m)	Northing (m)	WC ¹ anomaly	Backscatter ² anomaly	Soundings anomaly	Depth (m)	Description
A1	434686	4838532	no	yes	yes	23.4	Circular patch (~7m radius) of diffuse/irregular soundings above and (mostly) below fairly flat seabed
A2	434262	4839751	no	no	yes	16.7	elliptical (2m x 1m x 1m) / football-shaped anomaly on seabed with a few irregular soundings above seabed
A3	436995	4836870	no	yes	yes	32.5	Circular patch (approx 8-10m radius) of diffuse/irregular soundings above and (mostly) below fairly flat seabed in vicinity
A4	437181	4837102	no	yes	yes	32.5	Circular patch (approx 8-10m radius) of diffuse/irregular soundings above and (mostly) below fairly flat seabed
A5	435614	4834880	no	yes	yes	33.1	elongate (31m x 4m) anomaly with diffuse soundings concentrated ~1-2m below surrounding seabed with a handful of diffuse soundings ~1m above seabed
A6	434890	4834362	yes	yes	yes	32.4	polygonal (20m x 6m) depression with diffuse soundings concentrated ~1-2m below surrounding seabed with a handful of diffuse soundings ~1m above seabed
A7	434794	4833909	yes	yes	yes	32.4	irregular/polygonal (15m x 6m), slightly elongate feature dipping into seabed; soundings extend 2m above and 3m below surrounding surface
A8	435798	4833776	yes	yes	yes	38.8	polygonal (18m x 7m) feature with elongate cluster of soundings concentrated ~3m above seabed and irregular dipping cluster of soundings ~2-4m below seabed
A9	432074	4837003	yes	yes	yes	28.8	polygonal (9m x 4m) anomaly extending ~1m above seabed
A10	430397	4830075	no	yes	yes	70.7	elongate (29m x 4m) feature with many soundings concentrated below surrounding surface; a few soundings ~1-2m above surface
A11	431501	4829913	no	yes	yes	67.8	elongate to v-shaped (two ~32m limbs) extending ~2m-4m below surroundings seabed
A12	431430	4829340	yes	yes	yes	72.1	elliptical vertical cluster (7m x 13m) approx 6-12m above seabed
A13	432082	4829315	no	yes	yes	77.5	polygonal/block-like cluster of soundings (19m x 8m) extending 8-10m above seabed
A14	431034	4828614	no	yes	yes	80.6	polygonal feature (50m x 20m) extending ~10-12m above seabed; possible boulder

¹WC = water column anomaly observed at this location in real-time

²Backscatter anomaly defined as an area with notably different intensity than surroundings or acoustic shadow

Note: Vertical exaggeration and view (e.g. plan, oblique, cross-section, etc.) are not the same in each image.

A1

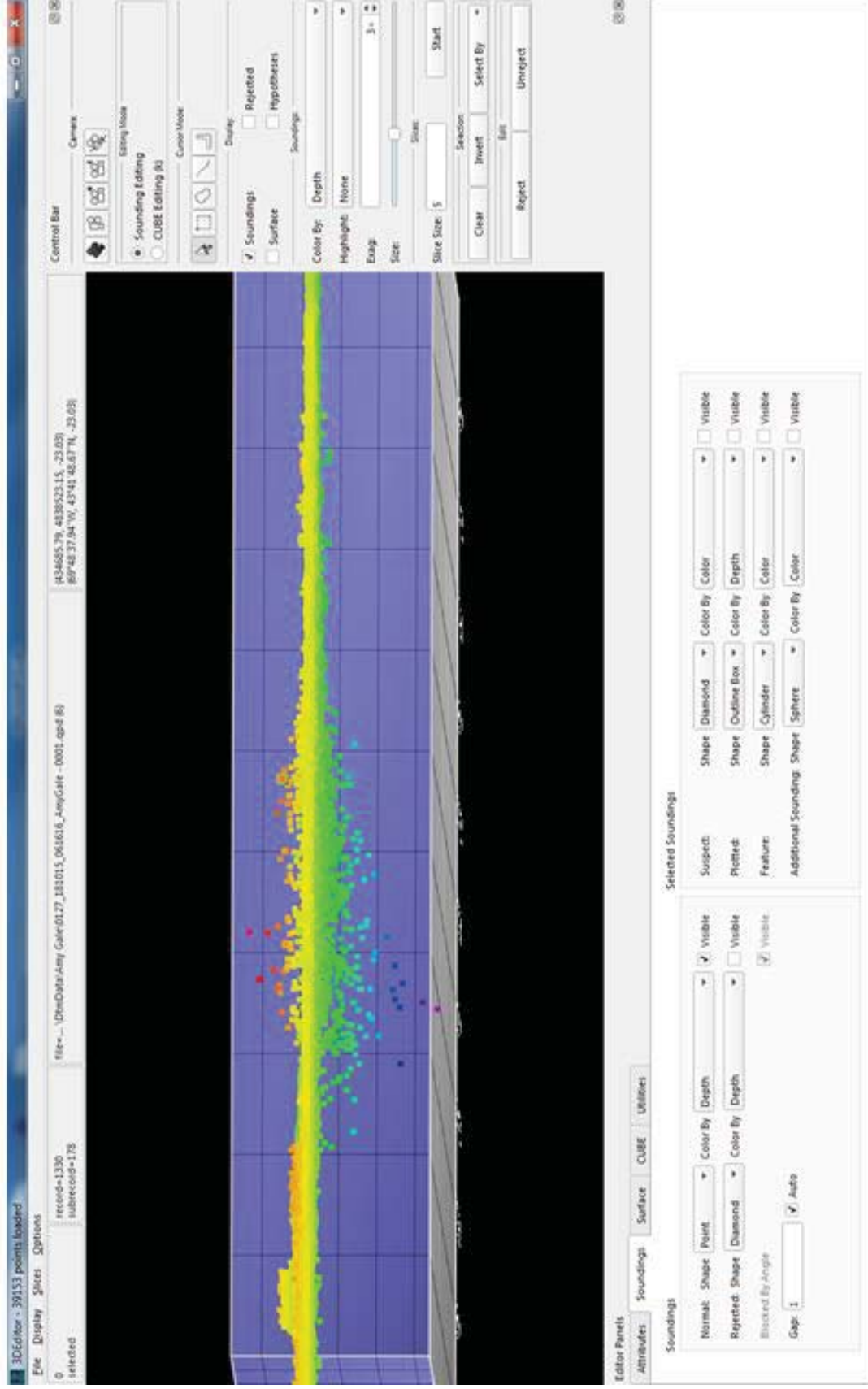

A2

The screenshot displays a 3D software interface for editing bathymetric data. The main window shows a dark blue bathymetric map with a small island or reef structure in the center, marked with several colored points (red, yellow, blue, green). The interface includes a top menu bar with 'File', 'Display', 'Slices', and 'Options'. Below the menu bar, there are status indicators: '3D Editor - 134373 points loaded', 'record=6554', and 'subrecord=230'. The 'Options' panel is open, showing 'file' and 'Dir' paths. The 'Control Bar' contains various tool icons and settings for 'Editing Mode' (Sounding Editing, CUBE Editing), 'Cursor Mode', 'Display' (Soundings, Rejected, Hypotheses), 'Sounding' (Color By: Depth, Highlight: None, Exage, Size), 'Slice Size' (5), and 'Section' (Invert, Select By). The 'Editor Panels' at the bottom include 'Attributes', 'Soundings', 'Surface', 'CUBE', and 'Utilities'. The 'Soundings' panel is active, showing settings for 'Normal Shape' (Point), 'Rejected Shape' (Diamond), 'Blocked By Angle' (2), and 'Gap' (2). The 'Selected Soundings' panel shows settings for 'Suspect', 'Plotted', 'Feature', and 'Additional Sounding' with various shape and color options.

A3

The screenshot displays a 3D software interface for bathymetric data. The main window shows a bathymetric map with a color scale from blue (shallow) to red (deep). The map is overlaid with a grid of soundings. The interface includes several panels and controls:

- Control Bar:** Contains icons for various functions like pan, zoom, and rotate.
- Editing Mode:** Includes checkboxes for "Sounding Editing" and "CUBE Editing (B)".
- Cursor Mode:** Includes icons for different cursor types.
- Display:** Includes checkboxes for "Soundings", "Surface", "Rejected", and "Hypobathes".
- Soundings:** Includes dropdown menus for "Color By" (Depth), "Highlight" (None), and "Etag" (1+). It also has a "Size" slider and a "Start" button.
- Section:** Includes buttons for "Clear", "Invert", "Select By", and "Reject".
- Editor Panels:** Includes tabs for "Attributes", "Soundings", "Surface", "CUBE", and "Utilities".
- Soundings Panel:** Includes dropdown menus for "Normal: Shape" (Point), "Rejected: Shape" (Diamond), and "Blocked By: Angle". It also has a "Gap" dropdown set to "Auto".
- Selected Soundings Panel:** Includes dropdown menus for "Shape" (Diamond, Outline Box, Cylinder, Sphere) and "Color By" (Color, Depth, Color, Color). It also has checkboxes for "Suspect", "Plotted", "Feature", and "Additional Sounding".

A4

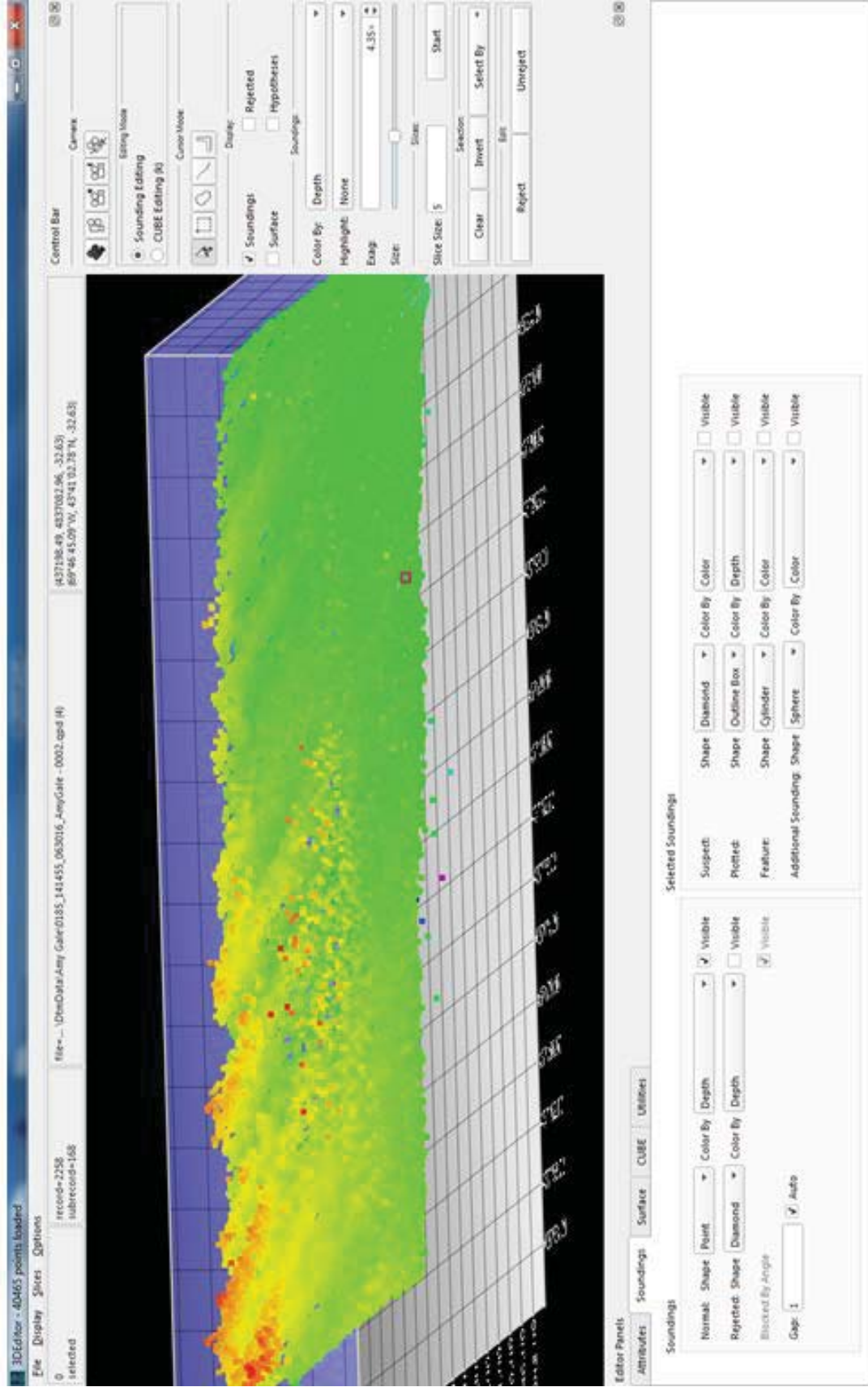

A5

3DEditor - 98048 points loaded

File Display Slivers Options

record-2080
subrecord-282

File... | D:\Data\Amy\Gain\0331_134502_071116_AmyGate - 0001.qpd (S)

435616.70, 4834883.91, -31.380
89°47'34.79"W, 43°39'51.01"N, -31.366

Control Bar

Camera

Editing Mode

Soundings Editing
CUBE Editing (S)

Cursor Mode

Display

Soundings

Color By: Depth

Highlights: None

Exag: 5x

Size: [Slider]

Size: [Slider]

Start

Section

Clear Invert Select By

Reject Unreject

Editor Panels

Attributes Soundings Surface CUBE Utilities

Soundings

Normal: Shape Point Color By Depth Visible

Rejected: Shape Diamond Color By Depth Visible

Blurred By Angle [Slider] Visible

Gap: 2 [Slider] Auto

Selected Soundings

Suspect: Shape Diamond Color By Color Visible

Pictrod: Shape Outline Box Color By Depth Visible

Feature: Shape Cylinder Color By Color Visible

Additional Sounding: Shape Sphere Color By Color Visible

A6

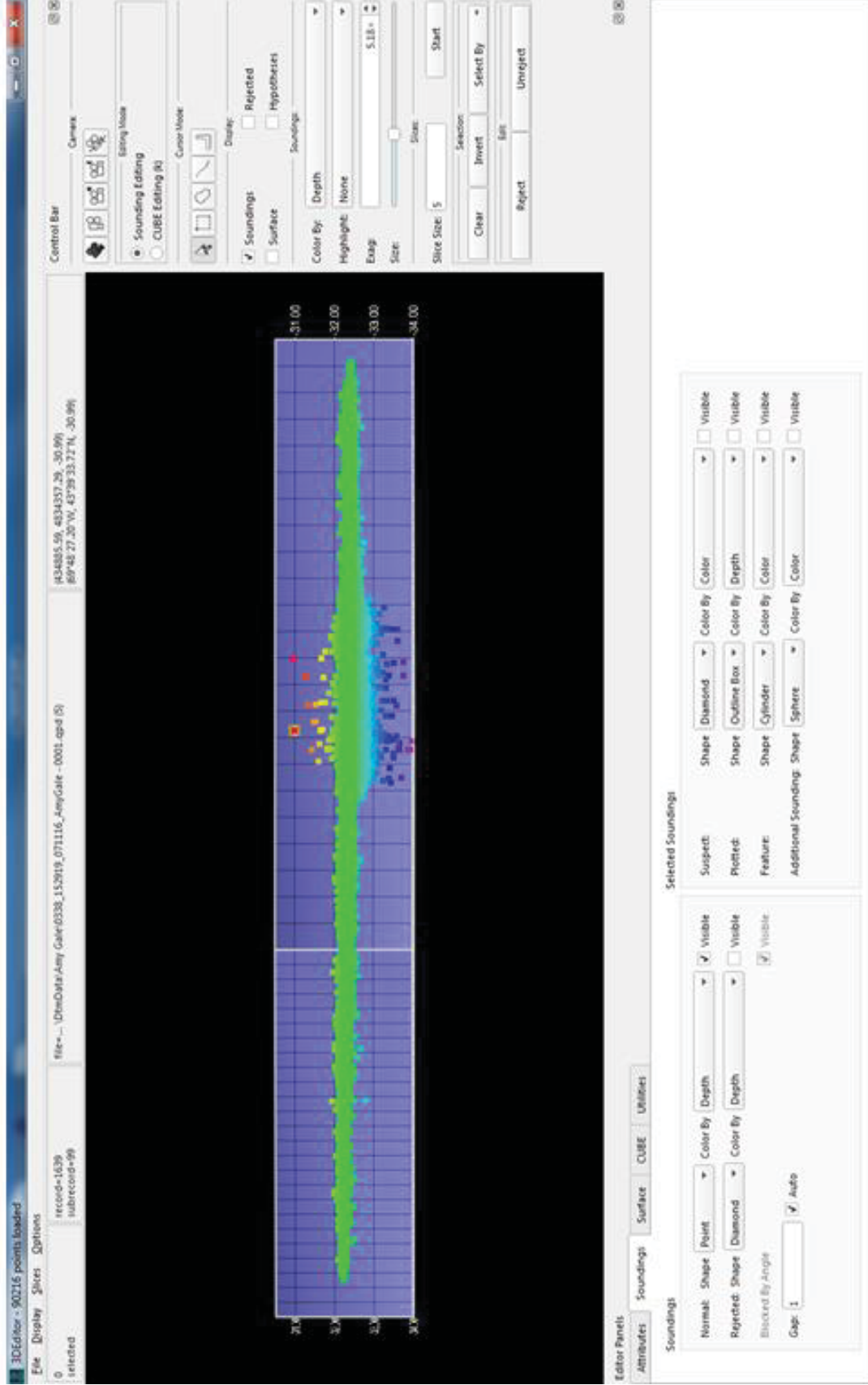

A7

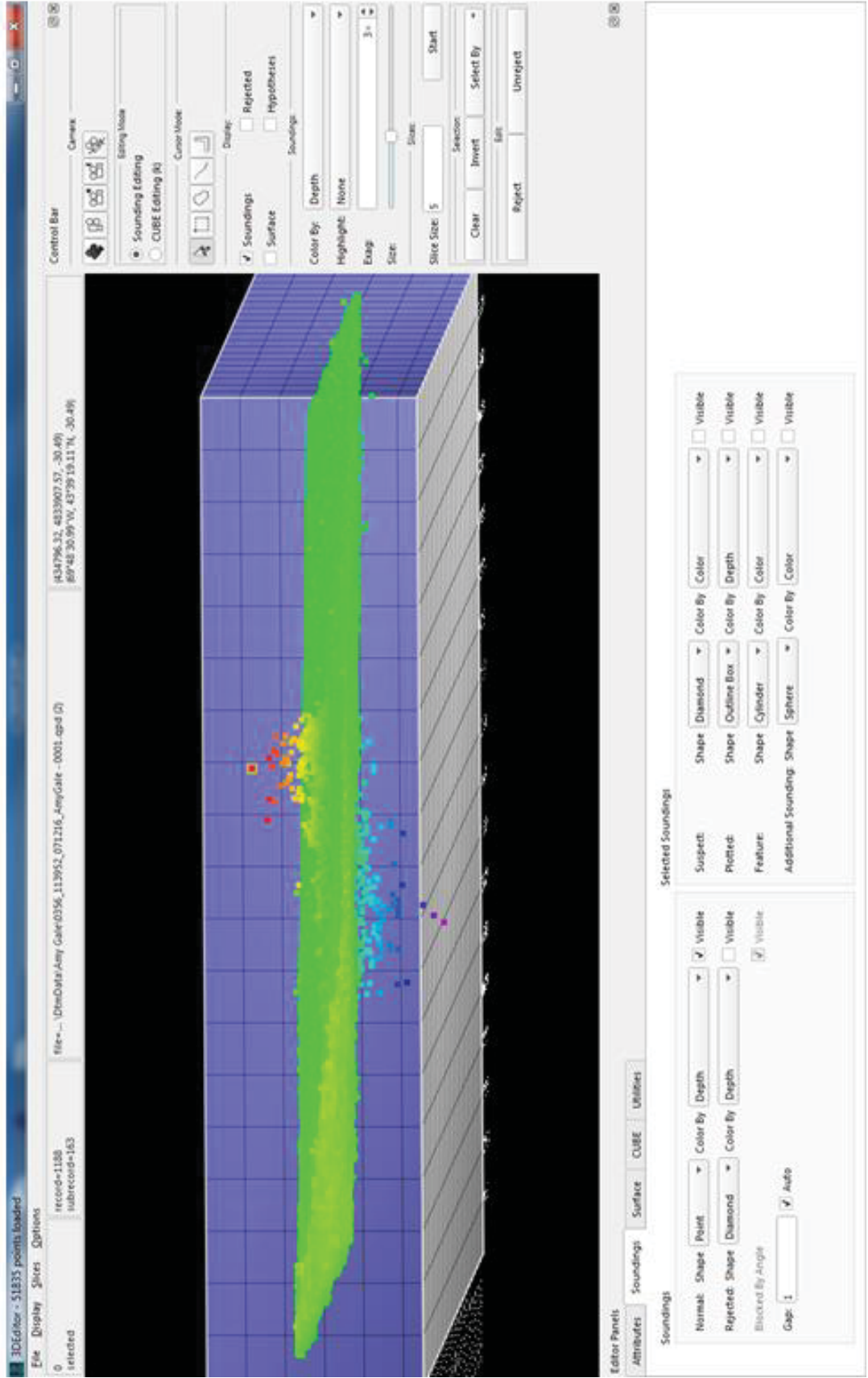

A8

3D Editor - 16012 points loaded

File -> Open -> Save -> Options

0 records - 134 columns - 4236

File: ... \GeoCatalAny_Gar236_2018_0713E_AnyGate - 0001.aprd 01

443796.05, 4832700.33, -41.50
[87°42'23.74", 42°29'14.67"N, -41.50]

Context Bar

Cones

Using Units

• Sounding Editing
○ CUBE Editing (N)

Copy Note

Draw

Soundings Rejected Hypotheses

Surface

Soundings

Color By: Depth

Highlight: Name

Keep: 1:1

Size: []

Site Size: 5 Start

Clear Insert Select By

Section

Report Edit Unreport

Editor Panel

Attributes | Soundings | Surface | CUBE | Utilities

Soundings

Normal: Shape Point Color By Depth Visible

Rejected: Shape Diamond Color By Depth Visible

Blocked by angle: Visible

Gap: 1 Auto

Selected Soundings

Suggest: Shape Diamond Color By Color Visible

Plotted: Shape Outline Box Color By Depth Visible

Feature: Shape Cylinder Color By Color Visible

Additional Soundings: Shape Sphere Color By Color Visible

A9

The screenshot displays the 3D editor interface with the following components:

- Top Panel:** Includes a file path, coordinates (43.2028, 82.4837, 109.70, -28.61), and a file name: `file*... \DtmData\Amy_Gair-0040_112034_092116_Amydate - 0001.apr-d (1)`.
- Control Bar:** Contains tool icons for Sounding Editing, CUBE Editing, and various editing modes like Sounding, Surface, Rejected, and Hypotheses.
- 3D Viewport:** Shows a 3D grid with a green surface and a cluster of colored points (red, yellow, orange) representing soundings.
- Editor Panels (Bottom):**
 - Attributes:** Includes 'record-id-1099' and 'subrecord-254'.
 - Soundings:**
 - Normal Shape: Point (Color By: Depth, Visible: checked)
 - Rejected Shape: Diamond (Color By: Depth, Visible: unchecked)
 - Blocked By Angle: checked
 - Gap: 1 (checked) Audio: checked
 - Selected Soundings:**
 - Suspect: Shape: Diamond (Color By: Color, Visible: unchecked)
 - Plotted: Shape: Outline Box (Color By: Depth, Visible: unchecked)
 - Feature: Shape: Cylinder (Color By: Color, Visible: unchecked)
 - Additional Sounding: Shape: Sphere (Color By: Color, Visible: unchecked)

A10

The screenshot displays a 3D software interface for editing bathymetric data. The main window shows a cross-section of a seabed profile with a color gradient from blue (shallow) to green and yellow (deeper). The interface includes several control panels:

- Control Bar:** Contains icons for editing tools and a 'Canvas' label.
- Editing Tools:** Includes 'Sounding Editing' and 'CUBE Editing (R)' options.
- Display:** Features checkboxes for 'Soundings', 'Surface', 'Rejected', and 'Hypobathies'.
- Sounding Settings:** Includes 'Color By' (Depth), 'Highlights' (None), 'Etag' (3), 'Size', 'Slice Size' (5), and 'Start' buttons.
- Selection:** Includes 'Clear', 'Invert', 'Select By', 'Reject', and 'Unreject' buttons.
- Editor Panels:**
 - Attributes:** Shows file path, record ID (1746), and subrecord ID (133).
 - Soundings:** Includes 'Normal: Shape' (Point), 'Rejected: Shape' (Diamond), 'Blacked By Angle', and 'Gap' (1) settings.
 - Selected Soundings:** Lists 'Suspect', 'Plot/ob', 'Feature', and 'Additional Sounding' with various shape and color options.

A11

3DEditor - 26185 points loaded
 File Display Slides Options
 record=1248
 subrecord=253

file... \DmsData\Amy Gate\0473_173546_072116_AmyGate_0002.qpd (d)

431514.32, 4829910.65, 49.980
 89°50' 55.67" W, 43°37' 08.51" N, 49.980

48299094.00
 48299096.00
 48299098.00
 48299100.00
 48299102.00
 48299104.00
 48299106.00
 48299108.00
 48299110.00
 48299112.00
 48299114.00
 48299116.00
 48299118.00
 48299120.00
 48299122.00
 48299124.00
 48299126.00
 48299128.00
 48299130.00
 48299132.00
 48299134.00
 48299136.00
 48299138.00
 48299140.00
 48299142.00
 48299144.00
 48299146.00
 48299148.00
 48299150.00
 48299152.00
 48299154.00
 48299156.00
 48299158.00
 48299160.00
 48299162.00
 48299164.00
 48299166.00
 48299168.00
 48299170.00
 48299172.00
 48299174.00
 48299176.00
 48299178.00
 48299180.00

Control Bar
 Camera
 Editing Mode
 Sounding Editing
 CUBE Editing (d)
 Cursor Mode
 Display:
 Soundings
 Surface
 Rejected
 Hypotheses
 Sounding:
 Color By: Depth
 Highlight: None
 Enagi: 4.34+
 Size:
 Slice Size: 5
 Slice: Start
 Section:
 Clear Invert Select By
 Bin
 Reject Unreject

Editor Panels
 Attributes Soundings Surface CUBE Utilities

Soundings

Normal: Shape Point Color By Depth Visible
 Rejected: Shape Diamond Color By Depth Visible
 Blocked By Angle Visible
 Gap: 1 Auto

Selected Soundings

Suspect: Shape Diamond Color By Color Visible
 Potted: Shape Outline Box Color By Depth Visible
 Feature: Shape Cylinder Color By Color Visible
 Additional Sounding: Shape Sphere Color By Color Visible

A12

3DEditor - 27360 points loaded

File Display Slides Options

records=3485
subrecords=68

file*... \DmData\Amy_Gair\0477_113542_072516_Amydate - 0001.apd (f)

431432.77, 4829401.75, -71.823
89°50'58.08"W, 43°26'53.86"N, -71.823

Control Bar

Gamma

Editing Mode

- Sounding Editing
- CUBE Editing (A)

Cursor Mode

Display

- Soundings
- Surface
- Rejected
- Hypothesis

Color By: Depth

Highlight: None

Exage: 1 =

Size: Start

Slice Size: 5

Section: Invert Select By

Reject Unreject

401.32
463.34
73.36
25.36

Editor Panels

Attributes Soundings Surface CUBE Utilities

Soundings

Normal Shape Point Color By Depth Visible

Rejected Shape Diamond Color By Depth Visible

Blocked By Angle Visible

Gap: 1 Auto

Selected Soundings

Suspect: Shape Diamond Color By Color Visible

Plotted: Shape Outline Box Color By Depth Visible

Feature: Shape Cylinder Color By Color Visible

Additional Sounding: Shape Sphere Color By Color Visible

A13

3DEditor - 21315 points loaded

File Display Slides Options

record-135
subrecord=234

file: \\... \DmData\Amy Gate\0405_123916_072518_AmyGate -0002.apr [1]

43.2022.16, 48.2907.39, -66.26)
89°50'30.07"W, 43°26'49.14"N, -66.26)

Control Bar

Camera

Editing Mode

Sounding Editing
 CUBE Editing (R)

Cursor Mode

Display:

Soundings
 Surface
 Rejected
 Hypotheses

Color By: Depth

Highlight: None

Exage: 1

Size: []

Slane: []

Slane Size: 5

Start

Section:

Clear Invert Select By

Reject Unreject

Editor Panels

Attributes Soundings Surface CUBE Utilities

Soundings

Normal Shape Point Color By Depth Visible

Rejected Shape Diamond Color By Depth Visible

Blocked By Angle Visible

Gap: 1 Auto

Selected Soundings

Suspect Shape Diamond Color By Color Visible

Plotted Shape Outline Box Color By Depth Visible

Feature Shape Cylinder Color By Color Visible

Additional Sounding Shape Sphere Color By Color Visible

A14

3DEditor - 15445 points loaded
 File Display Slides Options
 record=1207 subrecord=38
 File: ... \Data\Amy_Gair\049_142944_072510_AmyDate - 0001.apr-8 (f)
 431026.13, 4820617.30, -68.00
 89°31'18.88\"W, 43°36'26.42\"N, -68.00

Control Bar
 Gears
 Editing Tools
 Sounding Editing
 CUBE Editing (R)
 Cursor Mode
 Display:
 Soundings
 Surface
 Hypotheses
 Rejected
 Hypotheses

Soundings
 Color By: Depth
 Highlight: None
 Exag: 0.54
 Size: [Slider]
 Slice Size: 5 Start
 Section: Invert Select By: [Dropdown]
 Reject Unreject

Editor Panels
 Attributes Soundings Surface CUBE Utilities
 Soundings
 Normal: Shape Point Color By Depth Visible
 Rejected: Shape Diamond Color By Depth Visible
 Blocked By Angle Visible
 Gap: 1 Auto

Selected Soundings
 Suspect: Shape Diamond Color By Color Visible
 Plotted: Shape Outline Box Color By Depth Visible
 Feature: Shape Cylinder Color By Color Visible
 Additional Sounding: Shape Sphere Color By Color Visible

APPROVAL PAGE

W00448

Data meet or exceed current specifications as certified by the OCS survey acceptance review process. Descriptive Report and survey data except where noted are adequate to supersede prior surveys and nautical charts in the common area.

The following products will be sent to NCEI for archive

- Descriptive Report
- Collection of Bathymetric Attributed Grids (BAGs)
- Processed survey data and records
- Geospatial PDF of survey products
- Collection of backscatter mosaics
- Bottom Samples

The survey evaluation and verification has been conducted according to current OCS Specifications, and the survey has been approved for dissemination and usage of updating NOAA's suite of nautical charts.

Approved: _____
Commander Meghan McGovern, NOAA
Chief, Atlantic Hydrographic Branch