

**STATE OF MAINE**  
**DEPARTMENT OF ENVIRONMENTAL PROTECTION**  
**BOARD OF ENVIRONMENTAL PROTECTION**

NORDIC AQUAFARMS, INC.  
 Belfast and Northport  
 Waldo County, Maine

IN THE MATTER OF  
 :APPLICATIONS FOR AIR EMISSION,  
 :SITE LOCATION OF DEVELOPMENT,  
 :NATURAL RESOURCES PROTECTION  
 :ACT, and MAIN POLLUTANT  
 :DISCHARGE ELIMINATION SYSTEM  
 :(MEPDES)/WASTE DISCHARGE  
 :LICENSE

A-1146-71-A-N

L-28319-26-A-N

L-28319-TG-B-N

L-28319-4E-C-N

L-28319-L6-D-N

L-28319-TW-E-N

W-009200-6F-A-N

ME0002771

**Assessment of the Nordic Aquafarms Permit to Satisfy  
 Clean Water Act Requirements**

**TESTIMONY/EXHIBIT:**

NVC/UPSTREAM 1

**TESTIMONY OF:**

Brian Dixon

December 13, 2019

**DATE:**



December 10, 19

## Fish Disease and Aquaculture Facility Implications

Brian Dixon, PhD

Professor of Biology

Canada Research Chair in Fish and Environmental Immunology

Fish disease is a serious problem for the aquaculture industry and some estimates suggest that facilities at Maine latitudes can lose up to 34% of their stock to disease over the whole life cycle<sup>1</sup>. There are measures that can be taken to mitigate the effect of disease, but the installation of a facility which grows salmon through both their fresh and salt water life phases would have difficulty implementing some of those measures and thus could potentially become a point source for fish diseases from their outflow pipes.

Firstly, there are numerous bacteria and viruses that are ubiquitous in the ocean water of the North Atlantic and many are opportunistic pathogens. Examples would be infectious salmon anaemia virus and the bacterium *Aeromonas salmonicida*. In order to filter pathogenic bacteria from ocean water, one would need to filter that water through a 0.22 micrometer (um) filter, which would slow the pumping of the water and would likely clog easily. No filter is stringent enough to filter out viral particles. A 0.1 um filter would not filter viruses, which are nanometers in diameter and would clog even more frequently. Once a pathogen entered a larger recirculating system, it would be extremely difficult to clear it out and would probably involve euthanizing all the animals and bleaching the system at a minimum.

Below is information regarding specific viruses and bacteria that should be of concern.

For information on Infectious salmon anemia (ISA) or ISAv. ("v" for virus), a virus that is endemic to the Atlantic, see: :

<https://doi.org/10.1111/jfd.12670>

For information on Infectious Pancreatic Necrosis (IPN) or IPNv, a virus that is endemic to Atlantic Canada and therefore probably to Maine as well, see the fact sheet at:

<http://www.inspection.gc.ca/animals/aquatic-animals/diseases/reportable/infectious-pancreatic-necrosis/fact-sheet/eng/1330099413455/1330099555496>

For information on the bacterium, *Aeromonas salmonicida*, that is also common in the North Atlantic, see:

[https://en.wikipedia.org/wiki/Aeromonas\\_salmonicida](https://en.wikipedia.org/wiki/Aeromonas_salmonicida)

Ultraviolet (UV) systems can lose up to 40% of their initial efficiency in one year's time, therefore the UV light bulbs must be changed frequently for full effect<sup>2</sup>. Not all viral strains respond well to UV disinfection. For example, the infectious pancreatic necrosis (IPN) virus is hard to kill with UV. Additionally, the turbidity (i.e., lack of water clarity) in a waste stream negatively affects UV efficiency. One must have at least two of these systems in serial as backup in case one of them fail. Often a non-UV backup system is required that relies on treatment with ozone and chlorine, for example. Ozone can only be used as an effective treatment technique with fresh water as its use on saltwater produces hypobromous acid (bromine gas in water) from the bromides that naturally occur in seawater. The use of Chlorine as a treatment technique introduces the problem of trihalomethane production. That would be an undesirable outcome, from a water quality standpoint. However, backup treatment is still needed.

The RAS filters specified in the treatment system can get dirty quickly and if not kept properly can harbor pathogens. However, this question is not one that I, Brian Dixon, have the experience to answer conclusively. I would suggest that Nordic and the DEP consider the biosecurity implications of the filtering system. It may be prudent to modify the treatment design such that each tank has its own bioreactor, knowing that even then some wastes will be discharged to the bay as the treatment systems adjust to changes in the mix of fresh and salt water in the effluent and it will be very difficult to maintain the microbiota in a system that mixes or switches between fresh and salt water as the microbes that thrive in those two conditions differ greatly.

If separate systems for fresh and saltwater are used, then ozone treatment can be used on the freshwater flows. If the fresh and saltwater will be mixed together, Nordic must assess and perhaps control the impact of antimicrobials on bioreactor efficiency. There is also a lot of concern about antimicrobials that are released into the environment causing an increase in antimicrobial resistance in pathogens of both animals and humans. A clear plan to ensure there is not excessive release of those compounds should be in place.

In a closed system, it is unlikely that disease will be spread by fish that might, through some unlikely scenario, actually escape into the Penobscot Bay. However, if the Nordic plant receives salmon eggs from an outside source (thus requiring transportation) or sells smolts raised at the facility to another entity (also requiring transportation), it is possible that diseases could be introduced into the facility with the eggs or exported elsewhere with the smolts. One such incident involving salmon eggs occurred in Chile in 2007<sup>3</sup>. A Chilean facility – the 2<sup>nd</sup> largest producer of salmon in the world – was shut down due to infected imported

eggs from Iceland. Pathogens are numerous. In Western Canada eggs cannot be imported from outside. While eggs can be tested randomly, this is not very accurate since each female salmon produces some 10,000 eggs. The incidence of disease in unvaccinated fish ranges between 50-60% of a population, while the range for vaccinated populations can be reduced to 20-30%. Parasites can also be an issue and are difficult to control. Parasites cannot be vaccinated against currently. The use of anti-parasite drugs (ivermectin is commonly used) is usually reserved for use after an outbreak is detected in a population.

Climate change will also be a concern. Warming ocean water will bring in new pathogens. Relevant to this concern, the regulators may need to evaluate the effect of temperature changes on the level of stress salmon undergo in the wild. Temperature changes in the bay caused by the effluent discharge from a large-scale salmon-raising facility could be a problem. Fish are very sensitive to temperature changes and stress caused by such changes can decrease their immune function and increase the possibility of disease outbreaks. Indeed, this has been one of the main focuses of my work for the past 30 years<sup>4,5</sup>.

1. Leung, TLF and AE Bates (2013) *Journal of Applied Ecology*, 50:215–222
2. Summerfelt ST (2003) *Aquacultural Engineering* 28:21-36
3. <https://www.nytimes.com/2011/07/28/world/americas/28chile.html>
4. Abram, Dixon and Katzenback (2017) *Biology* 6, 39; doi:10.3390/biology6040039
5. Pérez-Casanova, J.C., Dixon, B., Rise, M.L., Afonso, L.O.B., Hall, J.R. and Gamperl, A.K. (2008) *Fish and Shellfish Immunology* 24:600-609,.



I certify under penalty of law that this document and all attachments were prepared under my direction or supervision in accordance with a system designed to assure that qualified personnel properly gather and evaluate the information submitted. Based on my inquiry of the person or persons who manage the system, or those persons directly responsible for gathering the information, the information submitted is, to the best of my knowledge and belief, true, accurate, and complete. I am aware that there are significant penalties for submitting false information, including the possibility of fine and imprisonment for knowing violations.



Date: Dec 16/19

Printed Name: BRIAN DIXON

Title: Professor and Canada Research Chair

Parties Assisting:

Name: Address: Signature: \_\_\_\_\_

Name: Address: Signature: \_\_\_\_\_



Brian Dixon appeared before me in Waterloo on Dec 16 2019 and deposed his signature above

  
Gloria Tschir  
Notary Public

PROVINCE OF ONTARIO

CANADA

PERSONALLY APPEARED, Brian Dixon, WHO UNDERSTANDING THE MEANING OF AN OATH, SWORE THAT THE FORGOING IS TRUE TO THE BEST OF HIS/HER KNOWLEDGE AND BELIEF, THIS 16 DAY OF DECEMBER 2019.

*Gloria Tchik*  
*[Signature]*

NOTARY PUBLIC OR THE EQUIVALENT

MY COMMISSION/AUTHORITY EXPIRES does not expire



**CURRICULUM VITAE****BRIAN DIXON**

Department of Biology  
University of Waterloo  
200 University Ave. W  
Waterloo, Ontario  
Canada, N2L 3G1

Phone: 1-(519)-888-4567  
ext 32665 (office)  
Fax: 1-(519)-746-0614  
E-mail: [bdixon@uwaterloo.ca](mailto:bdixon@uwaterloo.ca)  
<https://uwaterloo.ca/dixon-research-group/>

LANGUAGES SPOKEN: English, French, Nederlands, Castillian CITIZENSHIPS: Canadian and British

**POSITIONS HELD**

July 2009 – present	Dept. of Biology, Univ. of Waterloo	Professor
July 2005 – June 2009	Dept. of Biology, Univ. of Waterloo	Associate Chair, Department of Biology
July 2005-June 2009	Coral Reef Targeted Research Project Working Group	Associate Member
July 2004 – June 2009	Dept. of Biology, Univ. of Waterloo	Associate Professor
Sept. 2003 - Present	Ocean Sciences Centre, Memorial University of Newfoundland	Adjunct Professor
Sept 2000 – June 2004	Dept. of Biology, Univ. of Waterloo	Assistant Professor
Sept 2000 - Present	Institute for Molecular Biology and Biochemistry University of Waterloo	Member
July 1999 - Aug 2000	Department of Chemistry and Biochemistry University of Windsor	Cross-appointed Assistant Professor
Sept. 1998 - Present	Great Lakes Institute for Environmental Research University of Windsor	Researcher
Aug 1998 - Aug 2000	Department of Biological Sciences University of Windsor	Assistant Professor
Jan 1996 – Jul 1998	Department of Structural Biology Stanford University	Postdoctoral Fellow
Jan 1994 – Dec 1995	Wageningen Agricultural University Wageningen, The Netherlands	Postdoctoral Fellow
Sept 1989 – Aug 1990	Marine Gene Probe Laboratory, Dalhousie University	Research Technician
Sept 1988 – Aug 1989	Ontario Veterinary College University of Guelph	Research Technician

**EDUCATION**

1990-1993	Doctor of Philosophy, Dalhousie University, Department of Biology Thesis: Characterization of the gene encoding a 40 kDa major antigen of the sealworm ( <i>Pseudoterranova decipiens</i> ). 1993. Supervisor: Dr. B. Pohajdak
1985-1988	Master of Science, University of Guelph, Molecular Biology and Genetics Department Thesis: Subcellular distribution of the mRNAs for four housekeeping genes during the cell cycle. 1989. Supervisor: Dr. B. H. Sells
1981-1985	Bachelor of Science, Wilfrid Laurier University, Honours Biology Thesis: Electrophoretic characteristics of malate dehydrogenase isozymes in genotrophs of flax ( <i>Linum usitatissimum</i> L.).1985. Supervisor: Dr. M. A. Fieldes.

**COMMITTEES & SERVICE**

Sept 2018-present	Dept of Biology hiring committees (2)
Jan 2018-present	Dept of Biology Molecular Core committee
Sept 2016-Aug 2017	Provost's delegate, Faculty of Engineering Tenure & Promotion Committee
July 2016- present	Member, Board of Directors, Int. Soc. for Fish and Shellfish Immunology
April 2015-present	Organizer Sanofi Biogenius Challenge SW Ontario round
May 2015-present	Member, University Appointment Review Committee
Sept 2014-Aug 2015	Provost's delegate, Faculty of Engineering Tenure & Promotion Committee
July 2014-Feb 2015	Member, Dean of Science Selection Committee, University of Waterloo
July 2014-Feb 2017	Member of NSERC committee 1502
Sept 2013-present	Chair, University of Waterloo Animal Care Committee
May 2013-May 2014	Chair, Canadian Society for Zool., Parasitism, Immunology & Environment section
Jan 2013-present	Member, University of Waterloo Animal Care Committee
May 2012-May 2016	Councillor, Canadian Society of Zoology
May 2012-May 2013	Chair-Elect, Canadian Soc for Zool., Parasitism, Immunology & Environment section
July 2010- present	Treasurer of the Pan American Marine Biotechnology Asscn
May 2010-April 2016	Member of the University of Waterloo Senate
May 2009-April 2012	Member of the Faculty of Science Excellence in Science Teaching Award Committee
July 2008-present	Member of the Canada Research Chairs College of Reviewers
Dec 2007-May 2008	University Examination Integrity Working Group
Nov 2006-Apr 2007	Interim member, NSERC Committee 187, Cellular & Molecular Biology Scholarships
Sept 2006-Aug 2007	Provost's delegate, Faculty of Appl. Health Sciences Tenure & Promotion Committee
Sept 2006-Mar 2007	Dean of Science Nominating Committee, Univ of Waterloo
July 2006- July 2010	Secretary of Executive Committee of the Pan American Marine Biotechnology Asscn
July 2006- present	Executive Committee of the Pan American Marine Biotechnology Asscn
Nov 2005-Apr 2006	Chair, NSERC Committee 187, Cellular & Molecular Biology Scholarships
July 2005-July 2007	Member, Department of Biology Executive Committee
Jan 2005-Sept 2017	Member, Biology Department Merit Committee
July 2004- present	Member of University of Waterloo Research Park Access Team
May 2004-Oct 2004	Departmental Advisory Committee on Appointments: Animal Physiology
Nov 2003-Mar 2004	Departmental Advisory Committee on Appointments: Animal Physiology
Nov 2002- Dec 2004	Biomedical Science Undergraduate Advisor
Nov 2002-Feb 2005	Member, NSERC Committee 187, Cellular & Molecular Biology Scholarships
Sept 2002-Dec 2004	Univ. of Waterloo Dept of Biology Seminar Co-ordinator
Sept 2001-July 2005	Univ. of Waterloo Dept of Biology Sequencing Facility Manager
Aug 2001-Feb 2002	Univ. of Waterloo Dept of Biology Promotion and Tenure Committee
Aug 2001	Univ. of Waterloo. Dept of Biology CRC Senior Chair Selection Committee
July 2001-June 2004	Univ. of Waterloo Dept of Biology Executive Committee
May 2001-Sept 2002	Univ. of Waterloo Dept of Biology Work Term Report co-ordinator
Jan 2000-May 2000	Univ. of Windsor Biological Sciences Departmental Seminar Co-ordinator
Dec 1999-Aug 2000	Advisory Committee for the Ag. Canada Harrow Research Station
Nov 1999-Mar 2000	GLIER Post-doctoral Fellowship Committee
Nov 1999-Mar 2000	Chair, GLIER Ecotoxicology Hiring Committee
Nov 1999-Mar 2000	GLIER Conservation Genetics Hiring Committee
Oct 1999- Aug 2000	Univ. of Windsor Animal Care Training Course Co-ordinator
Oct 1999- Aug 2000	Univ. of Windsor Animal Care Committee
Sept 1999- Aug 2000	Univ. of Windsor Dept. of Biological Sciences Public Relations Committee
Sept 1999- Aug 2000	Univ. of Windsor Dept. of Biological Sciences Curriculum Committee
Sept 1999- Aug 2000	Univ. of Windsor Dept. of Biological Sciences Animal Facility Co-ordinator
May 1999- Aug 2000	ISDCI Graduate Student and Post-Doctoral Affairs Committee
Jan 1999- May 1999	Univ. of Windsor Biological Sciences Departmental Seminar Co-ordinator
Sept 1998-Sept 1999	Univ. of Windsor Dept. of Biological Sciences Counselling Committee
Jan 1992-Mar 1993	Lett Bursary Committee, Dept. of Biology, Dalhousie Univ.



Sept 1991-Aug 1992 President, Biological Organisation of Grad. Students, Dept. of Biol., Dalhousie Univ.

Sept 1990-May 1990 Co-Chair, Biological Environ. & Res. Seminars, Dept. of Biol., Dalhousie Univ.

### SOCIETY MEMBERSHIPS

American Association of Immunologists  
 Aquaculture Association of Canada  
 International Society for Comparative and Developmental Immunology  
 International Society for Fish and Shellfish Immunology  
 Pan-American Marine Biotechnology Association  
 Canadian Society for Immunology  
 Canadian Society of Zoologists

### AWARDS

Wardle Award	PIE section of Canadian Society of Zoologists	May 2015
Participation Award	Virtual Researchers on Call (Partners in Research)	May 2014
NSERC Synergy Award	Dept. of Biology University of Waterloo/Yellow Island Aquaculture Limited	July 2013 to June 2014
Canada Research Chair, Tier I	Dept. of Biology University of Waterloo	Nov 2011 to Pres
Jack Carlson Teaching Award	Dept of Biology University of Waterloo	Feb 2010
Outstanding Performance Awards	University of Waterloo	2005, 2009, 2014
Premier's Research Excellence Award (Ontario)	Dept of Biology University of Waterloo	Sept 2001 to Aug, 2003
Medical Research Council of Canada Postdoctoral Fellowship	Dept. of Structural Biology Stanford University School of Medicine, California, U. S. A.	May, 1996 to April, 1998
Natural Sciences and Engineering Research Council of Canada, Postdoctoral Fellowship	Dept. of Experimental Animal Morphology and Cell Biology Wageningen Agricultural University The Netherlands	Jan, 1994 to Dec, 1995
The Cedarlane Travel Award	Canadian Society for Immunology Spring Meeting, Lake Louise, Alberta	March, 1993
Canadian Society for Immunology Travel Award	8th International Congress of Immunology, Budapest, Hungary	August, 1992
Congress Travel Award	International Congress on Invertebrate Dioxygen Carriers. Lunteren, The Netherlands	April, 1992
Canadian Society for Immunology Travel Award	Canadian Society for Immunology Spring Meeting, Mont Gabriel, Québec	March, 1992
The Cedarlane Student Poster Award	Canadian Society for Immunology Spring Meeting, Lake Louise, Alberta	March, 1991
NSERC Undergraduate Summer Research Awards	Dept. of Biology Wilfrid Laurier University =	May to Aug., 1984, 1985

# *Aeromonas salmonicida*

*Aeromonas salmonicida* is a pathogenic bacterium that severely impacts salmonid populations and other species. It was first discovered in a Bavarian brown trout hatchery by Emmerich and Weibel in 1894.<sup>[1]</sup> *Aeromonas salmonicida*'s ability to infect a variety of hosts, multiply, and adapt, make it a prime virulent bacterium. *A. salmonicida* is an etiological agent for furunculosis, a disease that causes sepsis, haemorrhages, muscle lesions, inflammation of the lower intestine, spleen enlargement, and death in freshwater fish populations. It is found worldwide with the exception of South America.<sup>[1]</sup> The major route of contamination is poor water quality; however, it can also be associated stress factors such as overcrowding, high temperatures, and trauma. Spawning and smolting fish are prime victims of furunculosis due to their immunocompromised state of being.

## *Aeromonas salmonicida*

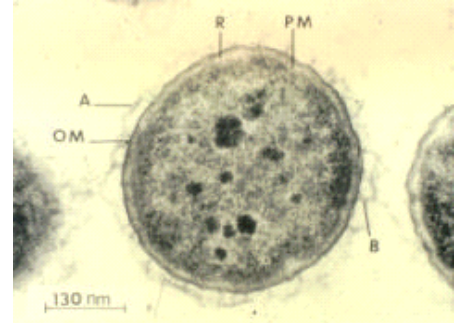

### Scientific classification

Domain:	Bacteria
Phylum:	Proteobacteria
Class:	Gammaproteobacteria
Order:	Aeromonadales
Family:	Aeromonadaceae
Genus:	<i>Aeromonas</i>
Species:	<i><b>A. salmonicida</b></i>
Subspecies:	<i><b>A. salmonicida</b></i>

### Binomial name

#### *Aeromonas salmonicida*

(Lehmann and Neumann 1896) Griffin et al. 1953

### Synonyms

*Bacillus salmonicida* (Lehmann and Neumann 1896) Kruse 1896  
*Bacterium salmonicida* Lehmann and Neumann 1896  
*Proteus salmonicida* (Lehmann and Neumann 1896) Pribram 1933

## Contents

### Morphology and bacterial characteristics

#### Cell structure and metabolism

#### Host range

#### Epizootiology

#### Pathology

#### Clinical symptoms and disease diagnosis

#### Detection

#### References

#### External links

## Morphology and bacterial characteristics

*Aeromonas salmonicida* is a Gram-negative, facultatively anaerobic, nonmotile bacterium. It is rod-shaped, about 1.3–2.0 by 0.8–1.3 μm in size, and grows optimally at temperatures between 22 and 25 °C.<sup>[1]</sup> The bacterium readily ferments and oxidizes glucose, and is catalase- and cytochrome oxidase-positive. Its molecular properties include a special surface protein array called the A-layer, which is believed to be responsible for the bacterium's virulent traits, and lipopolysaccharide, the cells' major cell envelope

antigen.<sup>[42]</sup> The A-layer consists of a 50-kD protein, and provides protection to the bacterium. The lipopolysaccharide consists of three moieties: lipid A, a core oligosaccharide, and an O-polysaccharide (O-antigen). The extracellular products of *A. salmonicida* consist of 25 proteins, enzymes, and toxins, and many more.<sup>[2]</sup> In addition, the genome is composed of a single circular chromosome (4,702,402 bp), with two large and three small plasmids. The chromosome yields 58.5% of G+C pairs, has 4086 encoding proteins, and totals 4388 genes.<sup>[3]</sup>

*A. salmonicida* isolates flourish when grown on blood agar or tyrosine. Large colonies are observed along with a brown diffusible pigment within two to four days. Most typical strains are morphologically and biochemically homogenous with a few exceptions. Some of these exceptions include a distinguishable variation in pigment production, the bacterium's ability to ferment selected sugars, and Voges-Proskauer assay results.

## Cell structure and metabolism

---

*A. salmonicida* is a facultative anaerobe, which means it is capable of making ATP by aerobic respiration if oxygen is present, but is also capable of switching to fermentation when oxygen is not present. It does not ferment sucrose or lactose, using glucose in this pathway, instead; glucose fermentation creates gas. The bacterium grows optimally at temperatures between 22 and 25 °C. The maximum temperature at which it can grow is 34.5 °C. After about a 24-hour growth period, the bacterial colonies reach about the size of a pin point. The colonies also have a brown pigmented color that appears after it has been growing for 48–72 hours.<sup>[4]</sup>

## Host range

---

- Salmon
- Trout
- Cyprinids
- Pike
- Perch
- Bullheads
- Turbot
- Halibut

## Epizootiology

---

*A. salmonicida*, an airborne pathogen, can travel 104 cm from its host into the atmosphere and back to the water,<sup>[5]</sup> thus making it difficult to control. The bacterium can maintain its pathogenicity in freshwater conditions for 6–9 months,<sup>[6]</sup> and in saltwater conditions for up to 10 days without a host. Several direct count methods and other detection methods have found the organism does not lose or reduces its titer concentrations.<sup>[7]</sup>

Transmission of furunculosis mainly occurs through fish-to-fish contact by the skin or by ingestion. Rainbow trout have been found to carry *A. salmonicida* up to two years after initial infection without re-exposure. Chemically immunosuppressed fish compared with temperature-stressed fish had a 73% mortality as opposed to a 33% mortality rate, respectively.<sup>[8]</sup> Naturally occurring trout infections consisted of a 5–6% mortality rate per week with an 85% rate in untreated populations. Some clinical

furunculosis survivors of an infected trout population became *A. salmonicida* carriers.<sup>[9]</sup> When comparing furunculosis epidemics with depressed oxygen levels, when oxygen concentrations were decreased to less than 5 mg/l, *A. salmonicida* concentrations increased.<sup>[10]</sup> While observing chum salmon in a density of 14.7 fish per square meter, 12.4% were infected with *A. salmonicida*, whereas, densities at 4.9 fish per square meter were infection-free.<sup>[11]</sup> Additionally, *A. salmonicida* concentrations were considerably elevated in water with low dissolved oxygen (6–7 mg/l), compared to water with higher dissolved oxygen (10 mg/l). High density-low oxygen water resulted in survival rates that were roughly 40% less than in those consisting of low density-high oxygen conditions.

## Pathology

---

The bacterium is pathogenic for fish, and causes the disease known as furunculosis.<sup>[12]</sup> The symptoms the fish show are external and internal hemorrhaging, swelling of the vents and kidneys, boils, ulcers, liquefaction, and gastroenteritis. Furunculosis is commonly known as tail rot in fish and is common in goldfish and koi. Infected fish with open sores are able to spread the disease to other fish.<sup>[4]</sup>

It is also one of several bacteria that can cause bald sea urchin disease.<sup>[13]</sup> Since *A. salmonicida* cannot grow at 37 °C, it is not pathogenic in humans.<sup>[14]</sup>

## Clinical symptoms and disease diagnosis

---

Furunculosis is classified into four categories based on severity: acute, subacute, chronic, or latent. When fish are infected, they become listless and weak until they die. Other characteristics observed include anorexia and lethargic movement, and they may exhibit a darkened pigment. Deep or shallow ulcers, exophthalmia, bloody spots, distended abdomen, and petechia at the base of the fin may also occur. Internally, the infected fish may suffer from gastroenteritis, hemorrhagic septicemia, edematous kidney, and an enlarged spleen. The liver may appear pale in color and the spleen may be darkened. The peritoneal cavity may also be bloody and inflamed.

Bacteria must be isolated to positively identify the disease. Isolates are retrieved from muscle lesions, kidney, spleen, or liver, and then grown on trypticase soy agar and brain-heart infusion medium incubated at 20–25 °C. Colonies of *A. salmonicida* appear hard, friable, smooth, soft, and dark in color.

While cultural procedures produce good results, serological procedures produce more rapid results by using serum agglutination, fluorescent antibody, or enzyme linked immunosorbent assay on infected tissue or cultured bacteria.<sup>[15]</sup> Mooney *et al.*<sup>[16]</sup> developed a DNA probe with polymerase chain reaction to detect *A. salmonicida* DNA; results were successful in 88% of wild Atlantic salmon.

## Detection

---

*A. salmonicida* tests negative for indole formation, coagulase, hydrolysis of starch, casein, triglycerides, and phospholipids, hydrogen sulfide production, citrate use, phenylalanine, and the Voges–Proskauer (butanediol fermentation) test. It tests positive for oxidase, lysine decarboxylase, methyl red, gelatin hydrolysis, and catalase.<sup>[4]</sup>

## References

---

1. "Furunculosis" ([http://aqua.merck-animal-health.com/diseases/furunculosis/ProductAdditional\\_127\\_113308.aspx](http://aqua.merck-animal-health.com/diseases/furunculosis/ProductAdditional_127_113308.aspx)). Merck. Archived ([https://web.archive.org/web/20150730032426/http://aqua.merck-animal-health.com/diseases/furunculosis/ProductAdditional\\_127\\_113308.aspx](https://web.archive.org/web/20150730032426/http://aqua.merck-animal-health.com/diseases/furunculosis/ProductAdditional_127_113308.aspx)) from the original on 30 July 2015. Retrieved 2011-06-11.
2. Chart, H.; Shaw, D.; Ishguro, E.; Trust, T. (April 1984). "Structural and immunochemical homogeneity of *Aeromonas salmonicida* Lipopolysaccharide" (<https://www.ncbi.nlm.nih.gov/pmc/articles/PMC215372>). *Journal of Bacteriology*. **158** (1): 16–22. PMC 215372 (<https://www.ncbi.nlm.nih.gov/pmc/articles/PMC215372>). PMID 6370955 (<https://www.ncbi.nlm.nih.gov/pubmed/6370955>).
3. Reith, M. E.; Singh, R. K.; Curtis, B.; Boyd, J. M.; Bouevitch, A.; Kimball, J.; Munholland, J.; Murphy, C.; Sarty, D.; Williams, J.; Nash, J. H.; Johnson, S. C.; Brown, L. L. (2008). "The genome of *Aeromonas salmonicida* subsp. *salmonicida* A449: insights into the evolution of a fish pathogen" (<https://www.ncbi.nlm.nih.gov/pmc/articles/PMC2556355>). *BMC Genomics*. **9**: 427. doi:10.1186/1471-2164-9-427 (<https://doi.org/10.1186%2F1471-2164-9-427>). PMC 2556355 (<https://www.ncbi.nlm.nih.gov/pmc/articles/PMC2556355>). PMID 18801193 (<https://www.ncbi.nlm.nih.gov/pubmed/18801193>).
4. Staley, James T.; Garrity, George M.; Boone, David R.; Castenholz, Richard W.; Don J. Brenner; Krieg, Noel R. (2001). *Bergey's manual of systematic bacteriology* (<https://archive.org/details/bergeysmanualofs00boon>). Berlin: Springer. ISBN 978-0-387-24145-6.
5. Wooster, Gregory A.; Bowser, Paul R. (1996). "The Aerobiological Pathway of a Fish Pathogen: Survival and Dissemination of *Aeromonas salmonicida* in Aerosols and its Implications in Fish Health Management". *Journal of the World Aquaculture Society*. **27**: 7–14. doi:10.1111/j.1749-7345.1996.tb00588.x (<https://doi.org/10.1111%2Fj.1749-7345.1996.tb00588.x>).
6. Michel, C.; Dubois-Darnaudpeys, A. (1980). "Persistence of the virulence of *Aeromonas salmonicida* strains kept in river sediments". *Annals of Veterinary Research*. **11** (4): 375–80. PMID 7337394 (<https://www.ncbi.nlm.nih.gov/pubmed/7337394>).
7. Rose, A; Ellis, E (1990). "The survival of *Aeromonas salmonicida* subsp. *salmonicida* in sea water". *The Journal of Fish Disease*. **13** (3): 205–214. doi:10.1111/j.1365-2761.1990.tb00775.x (<https://doi.org/10.1111%2Fj.1365-2761.1990.tb00775.x>).
8. Bullock, G. L.; Stuckey, H. M. (1975). "*Aeromonas salmonicida* detection of asymptotically infected trout". *The Progressive Fish-Culturist*. **37** (4): 237–239. doi:10.1577/1548-8659(1975)37[237:ASJ]2.0.CO;2 (<https://doi.org/10.1577%2F1548-8659%281975%2937%5B237%3AAS%5D2.0.CO%3B2>). ISSN 1548-8659 (<https://www.worldcat.org/issn/1548-8659>).
9. McCarthy, D. H. (1980). "Some ecological aspects of the bacterial fish pathogen *Aeromonas salmonicida*". *Aquatic Microbiology*: 299–324.
10. Kingsbury, Oliver R. (1961). "A Possible Control of Furunculosis". *The Progressive Fish-Culturist*. **23** (3): 136–137. doi:10.1577/1548-8659(1961)23[136:APCOF]2.0.CO;2 (<https://doi.org/10.1577%2F1548-8659%281961%2923%5B136%3AAPCOF%5D2.0.CO%3B2>).
11. Kimura, Takahisa; Yoshimizu, Mamoru; Nomura, Tetsuichi (1992). "An Epidemiological Study of Furunculosis in Salmon Propagation": 187–193. hdl:2115/39269 (<https://hdl.handle.net/2115%2F39269>).
12. "www.lsc.usgs.gov" (<https://web.archive.org/web/20090507003140/http://www.lsc.usgs.gov/FHB/leaflets/FHB66.pdf>) (PDF). Archived from the original (<http://www.lsc.usgs.gov/FHB/leaflets/FHB66.pdf>) (PDF) on 2009-05-07. Retrieved 2009-07-03.
13. Jangoux, M (1987). "Diseases of Echinodermata. I. Agents microorganisms and protists". *Diseases of Aquatic Organisms*. **2**: 147–162. doi:10.3354/dao002147 (<https://doi.org/10.3354%2Fdao002147>).

14. Altwegg, M.; Steigerwalt, A. G.; Altwegg-Bissig, R.; Lüthy-Hottenstein, J.; Brenner, D. (1990). "Biochemical identification of *Aeromonas* genospecies isolated from humans" (<https://www.ncbi.nlm.nih.gov/pmc/articles/PMC269587>). *Journal of Clinical Microbiology*. **28** (2): 258–264. PMC 269587 (<https://www.ncbi.nlm.nih.gov/pmc/articles/PMC269587>). PMID 2312673 (<https://www.ncbi.nlm.nih.gov/pubmed/2312673>).
15. Austin, B.; Bishop, I.; Gray, C.; Watt, B.; Dawes, J. (1986). "Monoclonal antibody- based enzyme-linked immunosorbent assay for the rapid diagnosis of clinical cases of enteric redmouth and furunculosis in fish farms". *Journal of Fish Disease*. **9** (5): 469–474. doi:10.1111/j.1365-2761.1986.tb01042.x (<https://doi.org/10.1111%2Fj.1365-2761.1986.tb01042.x>).
16. Mooney, J.; Powell, E.; Clabby, C.; Powell, R. (1995). "Detection of *Aeromonas salmonicida* in wild Atlantic salmon using a specific DNA probe test". *Diseases of Aquatic Organisms*. **21**: 131–135. doi:10.3354/dao021131 (<https://doi.org/10.3354%2Fdao021131>).

## External links

---

- Type strain of *Aeromonas salmonicida subsp. smithia* at BacDive - the Bacterial Diversity Metadatabase (<http://bacdive.dsmz.de/index.php?search=273&submit=Search>)
  - Type strain of *Aeromonas salmonicida subsp. masoucida* at BacDive - the Bacterial Diversity Metadatabase (<http://bacdive.dsmz.de/index.php?search=274&submit=Search>)
  - Type strain of *Aeromonas salmonicida subsp. salmonicida* at BacDive - the Bacterial Diversity Metadatabase (<http://bacdive.dsmz.de/index.php?search=275&submit=Search>)
  - Type strain of *Aeromonas salmonicida subsp. achromogenes* at BacDive - the Bacterial Diversity Metadatabase (<http://bacdive.dsmz.de/index.php?search=278&submit=Search>)
- 

Retrieved from "[https://en.wikipedia.org/w/index.php?title=Aeromonas\\_salmonicida&oldid=926858689](https://en.wikipedia.org/w/index.php?title=Aeromonas_salmonicida&oldid=926858689)"

---

**This page was last edited on 19 November 2019, at 00:16 (UTC).**

Text is available under the Creative Commons Attribution-ShareAlike License; additional terms may apply. By using this site, you agree to the Terms of Use and Privacy Policy. Wikipedia® is a registered trademark of the Wikimedia Foundation, Inc., a non-profit organization.



Review

# Impacts of Low Temperature on the Teleost Immune System

Quinn H. Abram, Brian Dixon  and Barbara A. Katzenback \*

Department of Biology, University of Waterloo, 200 University Ave West, Waterloo, ON N2L 3G1, Canada; qhabram@uwaterloo.ca (Q.H.A.); bdixon@uwaterloo.ca (B.D.)

\* Correspondence: barb.katzenback@uwaterloo.ca; Tel.: +1-519-888-4567 (ext. 30192)

Academic Editor: Jun Zou

Received: 20 October 2017; Accepted: 14 November 2017; Published: 22 November 2017

**Abstract:** As poikilothermic vertebrates, fish can experience changes in water temperature, and hence body temperature, as a result of seasonal changes, migration, or efflux of large quantities of effluent into a body of water. Temperature shifts outside of the optimal temperature range for an individual fish species can have negative impacts on the physiology of the animal, including the immune system. As a result, acute or chronic exposure to suboptimal temperatures can impair an organisms' ability to defend against pathogens and thus compromise the overall health of the animal. This review focuses on the advances made towards understanding the impacts of suboptimal temperature on the soluble and cellular mediators of the innate and adaptive immune systems of fishes. Although cold stress can result in varying effects in different fish species, acute and chronic suboptimal temperature exposure generally yield suppressive effects, particularly on adaptive immunity. Knowledge of the effects of environmental temperature on fish species is critical for both the optimal management of wild species and the best management practices for aquaculture species.

**Keywords:** teleosts; temperature; innate immunity; adaptive immunity; cytokines; macrophages; major histocompatibility class I; antigen presentation; lymphocyte proliferation; antibodies

## 1. Introduction

The impact of temperature changes on biological systems is an important topic in relation to global climate change and differences in seasonal temperatures. Higher frequencies and magnitudes of extreme temperature events such as cold snaps are occurring due to increasing climate variability [1,2]. The unprecedented cold-weather experienced in the Gulf of Mexico in 2010 is one example of these extreme temperature events and resulted in a 12°C and 6°C drop in air and water temperatures, respectively, over a two week period leading to widespread mortality in fish populations [3]. Furthermore, variance in seasonal water temperatures that fishes experience within a given year can be quite large, ranging from below 5°C to 19°C for a cold water species such as rainbow trout, and 16°C to 39°C for zebrafish, a warm water species [4–6]. The poikilothermic nature of fish requires special consideration in the face of these challenges as changes in water temperature equate to changes in body temperature and can impact key physiological processes, such as the immune system and ultimately the health of the animal [7,8].

While temperatures above the physiological range of a fish species triggers a stress response that can negatively impact immune function [9,10], so too can suboptimal temperatures have a negative impact on fish immunity and health. For example, water temperature is one factor when considering whether to transfer Atlantic salmon smolts to ocean pens as prevalence of the parasite *Kudoa thyrsites* on these fish was greatest when water temperatures were above 10°C in the summer and fall, and not detected in the winter and spring when the water temperature was below 10°C [11]. In contrast,

a number of fish-pathogen model systems exist in which an immunosuppressive effect of suboptimal temperatures is observed. For instance, olive flounder (*Paralichthys olivaceus*) is susceptible to viral haemorrhagic septicaemia virus (VHSV) at hypothermic temperatures such as 15°C with 24% mortality, whereas mortality is not observed when fish are maintained at 20°C [12]. Tilapia (*Oreochromis niloticus*) infected with *Streptococcus iniae* [13] or orange-spotted grouper (*Epinephelus coioides*) infected with *Vibrio alginolyticus* [14] suffered significant mortalities when placed in water that was 8°C below (or above) their thermal optimum. In cyprinids, infection of zebrafish with spring viraemia carp virus (SVCV) results in higher mortality rates when fish are kept at suboptimal temperatures [15]. As a final example, a natural model system exists which exemplifies the effects of temperature on the immune system and disease outcome in fish—the walleye, *Sander vitreus*, and walleye dermal sarcoma virus (WDSV) that causes cutaneous mesenchymal neoplasms [16]. Tumor progression has a seasonal cycle: appearing in late fall, persisting into early spring and then regressing in the summer [17], suggesting a link with temperature [16]. Once walleye recover in the spring/summer, they appear to develop immunity to WDSV [16]. It is hypothesized that cold stress negatively impacts walleye immunity and allows for virus proliferation, tumor formation and virus transmission. The aforementioned interactions between fish, pathogens and temperature speak to the complex interplay occurring that may result in compromised fish health. It is important to note that increases in pathogenesis at low temperatures may also be partially due to the effect of temperature on the virulence of the pathogen, which was reviewed by Guijarro et al. [18]. Herein we review the impact of hypothermic conditions on the innate and adaptive immune system of teleosts.

## 2. Innate Immunity and Temperature

### 2.1. Components of Innate Immunity

Like that of mammals, the teleost immune system consists of innate and adaptive arms (discussed below) [19,20]. The innate arm is constitutive and consists of germ-line encoded effector molecules (antimicrobial peptides, complement proteins) and cells (macrophages, neutrophils, basophils, eosinophils, cytotoxic cells) that recognize conserved microbial associated molecular patterns (MAMPs) [19–21]. Innate immune cells, such as macrophages and neutrophils, also produce hundreds of bioactive molecules that direct the initiation and resolution of an inflammatory response and are critical to the survival of an organism [22,23]. In particular, macrophages are arguably the central innate immune cell and recognize, uptake (phagocytosis) and neutralize pathogens and act to bridge the innate and adaptive arms by driving T cell responses through antigen presentation.

### 2.2. Complement

Complement proteins are the major soluble component of the innate immune system and consists of approximately 30 proteins that collectively comprise the classical, lectin and alternative complement pathways, reviewed in [24]. All three pathways lead to the formation of the membrane attack complex (MAC) that is cytolytic to target cells/microbes as well as the release of complement cleavage products that play a role in inflammation [24]. Despite being a prominent and essential component of immunity, few studies have examined the effect of suboptimal temperature on complement levels and activity. One study examined the short term exposure of tilapia (*Tilapia zillii*) to cold stress (17°C for 30 min) and found there was no difference in serum complement activity from these fish compared to control fish housed at 27°C [25]. However, it is difficult to ascertain the relevance of this particular study due to the short duration of thermal stress and the single fish species that was examined. Although few studies have investigated chronic exposure of fishes to cold stress, the studies conducted reveal conflicting responses of complement activity from different fish species. For example, lowered opsonization capacity and lytic activity of serum complement from rainbow trout acclimated to lower temperatures (5°C) over a period of greater than two months was observed compared to those fish maintained at higher temperatures (>10°C) [26]. In contrast, sockeye salmon possessed higher serum complement



activity when reared at 8°C versus 12°C [27]. The underlying mechanisms of complement regulation in these two fish species, both from the family *Salmonidae*, are unknown and suggest that even within a family of fish, suboptimal temperatures have differing effects on complement activity.

Studies investigating the impact of cold stress on complement molecule regulation in immunostimulated or infected fish are largely lacking. A study on rainbow trout demonstrated upregulation of C5a receptor transcript levels in the spleen and kidney of *Yersinia ruckeri* immunized (i.p.) animals regardless of temperature (5°C, 15°C or 25°C) [28], suggesting that cold stress may not impact upregulation of the complement system during pathogen challenge. However, further studies are needed in order to assess the impact of temperature on the complement system.

### 2.3. Leukocyte Numbers

The availability and proportion of leukocytes in the blood, kidney and spleen (the major immune organs of teleosts) are important indicators of the immunocompetence of an animal. In some cases, hypothermic temperatures had no effect on packed cell volume or percentage of blood leukocytes, such as in Atlantic halibut (*Hippoglossus hippoglossus* L.) (8°C versus 12°C–15°C) [29], or in the total number of anterior kidney neutrophils in channel catfish (10°C versus 24°C) [30]. Similarly, the percentage of monocytes, thrombocytes and granulocytes in the peripheral blood leukocyte (PBL) population or spleen did not differ between rainbow trout maintained at 12°C compared to 15°C [31]. However, study of other fish species provides contrasting results. In carp (*Cyprinus carpio*), circulating granulocyte numbers double in the blood, coinciding with a decrease in kidney granulocyte numbers, in response to acute hypothermic stress [32], while sockeye salmon reared at 8°C versus 12°C tended to have a higher percentage of phagocytic kidney macrophages and a decrease in peripheral blood lymphocytes [27]. Yet, members of the order Perciformes exhibit a decrease in the total blood leukocyte numbers as observed in orange-spotted grouper (*Epinephelus coioides*) [14], tilapia (*Oreochromis mossambicus*) [13] and hybrid striped bass (*Morone chrysops* × *Morone saxatilis*) at suboptimal temperatures [33], with hybrid striped bass also showing a reduction in blood monocyte numbers [33]. These data suggest that hypothermic temperatures impact orders of fishes differentially under non-challenged conditions.

The impact of suboptimal temperature on rainbow trout challenged with bacterial and protozoal pathogens revealed that leukocyte composition was affected by temperature during infection. Upon challenge with *A. salmonicida*, an increase in the percent of granulocytes in the PBLs, but not in the monocyte or thrombocyte population, was observed in rainbow trout maintained at 12°C. However, a much greater increase was observed in granulocyte numbers, as well as monocyte numbers, in the PBLs isolated from *A. salmonicida* challenged fish maintained at 15°C [31]. A similar result was observed in the number of monocytes in the spleen in which greater numbers were present in fish maintained at 15°C versus 12°C following *A. salmonicida* infection [31]. While the percentage of leukocytes in the peripheral blood of rainbow trout infected with the parasite *Tetracapsuloides bryosalmonae* also increased over time at both 12°C and 15°C, the increase was significantly greater at the higher temperature at all time points [34]. These data suggest that while innate immune cells can be actively mobilized during periods of low temperature, their maximal mobilization is dampened compared to those fish maintained at homothermic temperatures and may predispose these fish to infection.

### 2.4. Peripheral Blood Leukocyte Function

Examination of PBLs from fish exposed to acute or chronic hypothermic temperatures showed a generalized suppression in activity. The phagocytic index of blood leukocytes isolated from orange-spotted grouper (*Epinephelus coioides*) was reduced after 24 h, 48 h and 96 h at 8°C below their thermal optimum [14]. Similar results were observed in a study with tilapia (*Oreochromis mossambicus*) [13]. The phagocytic activity of rainbow trout blood leukocytes was also significantly reduced in rainbow trout acclimated to 5°C for over 2 months (versus 10°C or 15°C) [26].

The production of reactive oxygen species (ROS) was impaired in channel catfish [35], orange-spotted grouper [14], tilapia (*Oreochromis mossambicus*) [13] and rainbow trout [26] PBLs under hypothermic conditions. Despite pathogen challenge with *A. salmonicida*, rainbow trout maintained at a lower temperature (12°C versus 15°C) exhibited suppressed non-specific responses [31]. In particular, splenocytes and PBLs isolated from *A. salmonicida* challenged fish maintained at 15°C cleaved tetrazolium salts to a greater extent than those maintained at 12°C, suggesting an impairment in cell activation or metabolism at lower temperatures [31]. Thus, it appears that acute and chronic cold stress compromises phagocytic activity and ROS production, suggesting a potential impairment of critical innate immune cell function for pathogen destruction.

### 2.5. Cytotoxic Cells

Fish cytotoxic cells are the precursors or equivalent of natural killer (NK)-cells in mammals, appearing to be morphologically distinct, but functionally similar as they have been shown to induce cytotoxicity in mammalian tumor cells and in fish protozoal parasites [19]. Studies on carp cytotoxic cells suggest there is an enhancement of killing activity of cytotoxic cells from fish maintained at hypothermic temperatures. In the first study, carp (*Cyprinus carpio*) were maintained at 25°C, but also acclimated to 10°C for varying durations up to 112 days. Natural killer-like cells were isolated from the kidney and used in a cytotoxicity assay that employed human K562 cells as target cells [36]. NK-like cells from carp maintained at 25°C had higher cytotoxic activity when the *in vitro* NK cell killing assay was performed at 25°C versus 10°C. Similarly, NK-like cells isolated from fish that had been maintained at 10°C for extended periods exhibited higher cytotoxic activity in *in vitro* NK cell killing assays when they were performed at 10°C compared to 25°C [36]. This study suggests that fish innate immune cells are capable of adjusting to long-term hypothermic conditions in which these new temperature conditions are adapted to as normothermic conditions thus allowing NK-like cells to maintain their function [36]. In addition, this study illustrated the importance of selecting appropriate *in vitro* assay conditions (i.e., temperature) for assessment of *ex vivo* cell functions. Similar results were obtained by another group that observed an enhancement of cytotoxic cell activity from carp maintained at 12°C (versus 20°C) for 28 or 42 days [37,38]. However, cytotoxic activity returned to baseline levels by 56 days post transfer of fish to 12°C from 20°C [37]. Interestingly, and in contrast with the aforementioned study, at no time point examined was there a suppression in cytotoxic cell activity compared to those cytotoxic cells from carp maintained at 20°C [37]. Furthermore, activity of cytotoxic cells from cold acclimated fish could not be enhanced *in vitro* if placed at 12°C [38]. These studies suggest that cytotoxic cells are able to adapt to cold temperatures *in vivo*, at least in cyprinids, and may compensate for other aspects of fish immunity that may be negatively impacted by hypothermic temperatures.

### 2.6. Macrophages and Granulocytes

Macrophages and neutrophils are central innate immune cells and are important phagocytic cells as well as producers of reactive oxygen species, amongst an array of antimicrobial arsenal [39–41]. Studies on the impact of suboptimal temperatures on macrophages and neutrophils (granulocytes) have generally revealed either no change in their activity or an enhancement of activity. There was no significant difference in the respiratory burst activity of rainbow trout macrophage isolated from the kidney in response to macrophage activating factor (MAF) under low temperatures conditions *in vitro* [42]. Meanwhile, rainbow trout neutrophils had reduced ROS production in response to phagocytic stimuli at lower *in vitro* temperatures [43]. However, the aforementioned studies were performed *in vitro* and thus may not be reflective of *in vivo* conditions. *In vivo* studies on pronephros macrophages isolated from carp (*Cyprinus carpio*) maintained at 12°C (versus 20°C) for 28 days had both a higher respiratory burst response and phagocytic index [44]. Similarly, tench (*Tinca tinca* L.) blood granulocytes from fish maintained at 12°C (winter temperatures) displayed greater phagocytic capacity and production of superoxide anions than that of blood granulocytes from fish maintained at

22°C [45]. These studies suggest that the cellular components of the innate immune system may be enhanced during long-term exposure to hypothermic temperatures thus allowing for compensation in other areas of immune deficits.

### 2.7. Expression of Genes Involved in a Proinflammatory Response

The effects of hypothermic temperatures on the expressions of various immune genes including proinflammatory cytokines, antiviral pathway proteins and Toll-like receptors (TLRs) during fish ontogeny have been most studied in zebrafish. During zebrafish ontogeny, studies suggest a suppression of *il1b*, *tnfa*, *ifn1*, *ifng*, *inos*, *irf3*, *mda5* and *mx* expressions at suboptimal temperatures (15°C compared to 28°C), while the expression pattern of *tlr3* [46], *tlr21* and *tlr22* [47] remained unchanged. Additionally, in Atlantic salmon parr, gene expression of *mx* was delayed at 6°C relative to 14°C following poly I:C injection, but was longer lasting, suggesting that lower temperatures decrease the kinetics of this particular response and perhaps others, but do not eliminate the response completely [48]. Furthermore, developing zebrafish revealed their use as a temperature-dependent model of anemia. Zebrafish raised at cooler temperatures (17°C versus 26.5°C) for up to 7 months display a selective decrease in erythrocytes, but not myeloid cells, resulting in an anemic state [49]. Examination of the gene expression of key growth factors involved in hematopoiesis revealed a decrease in the expression of erythropoietin (*epo*) and erythropoietin receptor (*epor*) in kidney marrow, important for erythropoiesis [50–52], but not in colony-stimulating factor-1a (*csf1a*) or *csf3* expressions that are important for generation of macrophages and granulocytes, respectively [49,53–55]. These studies suggest that while macrophages and granulocytes (neutrophils) are still produced at normal levels, the expressions of key proinflammatory cytokines and proteins involved in viral recognition may be suppressed or delayed, at least at the transcript level, under hypothermic levels during fish ontogeny.

In adult fish, hypothermic temperatures appear to suppress or delay the production of key innate immune molecules in fish in response to pathogen mimics or pathogens themselves, suggesting a block in the induction of a proinflammatory or antiviral response. For example, rainbow trout head kidney leukocytes treated with lipopolysaccharide (LPS) *in vitro* displayed higher *il1b* mRNA levels at 22°C than at 14°C and transcription of *il1b* mRNA was completely blocked at 4°C [56]. *In vivo* experiments tend to follow a similar trend. In sevenband grouper (*Epinephelus septemfasciatus*) injected with poly I:C, inducible expression of *mx* transcripts in the head kidney were lower in fish maintained at 15°C and 20°C compared to those fish maintained at 25°C [57]. In rainbow trout immunized (i.p.) with *Yersinia ruckeri*, *il1b* and *ifng* transcript levels were upregulated in the spleen and kidney regardless of temperature (5°C or 15°C) [28], however, the upregulation of the proinflammatory transcripts occurred slightly faster at the optimal temperature [28]. Furthermore, only *il10* transcripts were induced following *Y. ruckeri* vaccination of rainbow trout maintained at 15°C, but not at 5°C, while no changes were observed in *tgfb* transcript levels in fish maintained at either temperature [28]. However, the route in which rainbow trout were vaccinated with *Y. ruckeri* impacted whether temperature dependent effects on proinflammatory cytokine expression were observed – bath vaccination of rainbow trout did not produce the same results as that of intraperitoneal vaccination [58]. Despite differing results in regulation of proinflammatory transcript levels, fish that were bath vaccinated with *Y. ruckeri* and maintained at 15°C were able to survive subsequent homologous challenge infection whereas fish at 5°C were not [58]. These data suggest that resolution of *Y. ruckeri* infection in trout is temperature dependent and, although the mechanism of protection remains to be fully elucidated, it appears that production of proinflammatory cytokines plays a role [58].

### 2.8. Antigen Presentation Pathway

Based on studies in mammals, antigen processing and loading for major histocompatibility complex (MHC) I and II occurs through a complex process guided by accessory molecules. In the endogenous pathway, cytosolic proteins are digested by the proteasome into peptides [59],

which are then transported into the lumen of the endoplasmic reticulum (ER) by the transporter associated with antigen processing (TAP) where they will be loaded into the peptide binding groove of MHC I [60]. The nascent MHC class I heavy chain is synthesized by ribosomes along the rough ER and secreted into the ER. MHC I heavy chain is unstable and is stabilized by binding to the chaperone calreticulin [61]. The small subunit of the receptor, beta-2 microglobulin ( $\beta_2M$ ), joins this complex and the calreticulin is replaced by calnexin [61]. This complex is recruited to TAP by the chaperones ERp57 and tapasin [61]. Tapasin assists in loading the peptides from TAP into the peptide binding groove of MHC I [61]. Once the appropriate peptide is loaded, the MHC I heavy chain: beta-2 microglobulin: peptide trimer is stable and can shed the chaperones and traffic to the cell surface to present the peptides to CD8+ T cells.

In the exogenous pathway, nascent MHC II alpha and beta chains are also synthesized along the rough ER and fold together in the lumen with the assistance of the MHC II Associated Invariant Chain (Ii), which also blocks the peptide binding groove of MHC II to prevent binding of endogenous peptides in the ER lumen [62]. Ii trafficks the MHC II into endosomes that then fuse with lysosomes containing peptides produced from exogenous proteins that the APC has internalized by phagocytosis, pinocytosis or receptor mediated internalization. Here the Ii is proteolytically degraded until only the Class II associated Invariant Peptide (CLIP) remains bound in the peptide binding groove and another chaperone, DM, facilitates the replacement of CLIP with the exogenously derived peptides [62]. Once again, when a stable trimer comprising the two MHC polypeptide chains and a peptide is formed, the complex is stable and moves to the cell surface to present antigen to CD4+ T cells. Antigen presentation to T cells initiates and directs the type of resulting adaptive immune response: a cell-mediated response or an antibody-mediated response. Clearly, the initiation of an adaptive immune response by phagocytes for defense against pathogens greatly depends on antigen presentation.

Studies have shown cold stress to influence antigen presentation in fish. In carp, cell surface MHC I was downregulated at 6°C (versus 12°C), and appeared to be due to decreased  $\beta_2M$  mRNA transcription [63]. However, in cold-adapted fish species such as rainbow trout and Atlantic salmon,  $\beta_2M$  is still synthesized by cells and is trafficked to the surface along with MHC I at 2°C, suggesting that these fish species may be adapted for detecting viruses at low temperatures, contrary to mammals and other fish species [64]. Subsequent studies, however, have shown that there is no accumulation of  $\beta_2M$  in the media of stimulated or nonstimulated cells cultured at 2°C, suggesting that while the MHC I receptor is present on the cell surface, it is not functional [65]. Conversely, MHC II expression is downregulated at 2°C—but not 5°C—in rainbow trout cells, suggesting a susceptibility to bacterial diseases during cold stress [66]. Recent studies have identified, characterized and produced polyclonal antibodies to rainbow trout genes involved in the antigen processing pathway (APP) including MHC I [67],  $\beta_2M$  [64], TAP1/2 [68] tapasin [69], calreticulin [70,71], ERp57 [72] and calnexin [73]. Collectively, these studies demonstrate the largely conserved nature of the APP in rainbow trout. Studies have also examined the regulation of the APP in response to viral infection with viral hemorrhagic septicemia virus (VHSV) in conjunction with cold [65]. These data demonstrate an increase in the protein levels of MHC I,  $\beta_2M$  and tapasin in rainbow trout cells infected with VHSV at 14°C [65]. As previously reported, MHC I and  $\beta_2M$  protein levels do not change with cold stress [65]. If, however, cells were infected at 2°C (cold stress), the VHSV-infected cells failed to upregulate protein levels of MHC I,  $\beta_2M$  and tapasin [65], suggesting cold stress has a negative impact on antigen presentation, and leads to an impaired immune response when challenged with a pathogen.

Using a newly developed Arctic char cell line, Semple et al. [74] observed that there was also no difference in the protein levels of MHC I and  $\beta_2M$  at 1, 4 or 14°C in nonstimulated cells. Arctic charr are particularly adapted to very cold temperatures and thus may have evolved mechanisms to maintain antigen presentation pathways in the cold. Interestingly for this cell line, MHC I,  $\beta_2M$  and ERp57 protein levels did not increase with poly I:C treatment at 14°C, suggesting that the regulation of the Arctic charr antigen presentation pathway differs in response to temperature from that of other

salmonids, perhaps due to their adaptation to colder temperatures. The lack of MHC I,  $\beta_2M$  and ERp57 protein level upregulation was specific to the APP and not an impairment of immunity altogether, as Mx protein was induced by doses of poly I:C as low as 10  $\mu\text{g}/\text{mL}$  in 24 h, at 14°C, and in cells exposed to 1°C or 4°C within 7 days at a dose of 50  $\mu\text{g}/\text{mL}$ . While there are general trends in the effects of temperature on immunity in teleost fish and specifically within the salmonids, there are species-specific differences that have likely evolved as adaptations to the environment that these species inhabit. Thus, while there have been some preliminary studies, the effects of thermal stress on APP function and MHC trafficking are largely unknown and represents a knowledge gap in terms of how antigen presentation is impacted in fish species facing increased magnitude and fluctuations in environmental temperatures.

### 3. Adaptive Immunity and Temperature

#### 3.1. Components of Adaptive Immunity

The adaptive arm of the vertebrate immune system is inducible, pathogen-specific, and generally results in immunological memory by cellular (B cells, T cells) and humoral (antibodies) components [19,20]. T lymphocytes recognize antigens presented by cells expressing MHC I and II and, upon recognition, induce specific cytotoxicity or release cytokines that act on other lymphocytes and innate immune cells to direct a specific response against a pathogen respectively [75]. B lymphocytes secrete antibodies upon antigen recognition/activation, which then perform a number of functions, including opsonization, neutralization, agglutination, and complement activation [76].

#### 3.2. B Lymphocytes

B lymphocytes are the producers of B-cell receptors and antibodies, the membrane and secreted forms of immunoglobulins (Igs) [76,77]. The majority of work to date studying the effects of suboptimal temperatures on these cell populations has been performed using channel catfish as a model. The magnitude of PBL proliferation in channel catfish in response to the B cell mitogen LPS was found to be relatively independent of the temperatures studied *in vitro*, but peak proliferation was delayed as the assay temperature decreased, with the greatest delay at 17°C relative to 22°C, 27°C, and 32°C [78]. However, when PBLs were isolated from fish maintained at 11°C compared to 24°C, proliferation was inhibited at both assay temperatures, 17°C and 27°C [79]. Additionally, the number of B cells in the blood decreased following exposure to 11°C, and did not recover until 5 weeks later, implying that channel catfish may decrease circulating B cells in response to large temperature decreases, but that they may be able to acclimate to the lower water temperature over time. Increases in unsaturated fatty acids in the plasma membrane have also been observed in B cells from fish acclimated to 17°C versus 24°C *in vivo*, and while the effect this change has on lymphocyte function has not been elucidated, the authors speculated that it stiffened cell membranes, decreasing cell-to-cell interactions and thus immune responses [80].

Studies in rainbow trout have also provided evidence of suboptimal temperatures adversely impacting B lymphocyte function. An increase in transcript expression was observed at 15°C for all B cell markers studied (secretory *igm*, membrane-bound *igt*, *pax5*, and *blimp1*) in the anterior kidney post-infection with *Tetracapsuloides bryosalmonae*, and for all but IgT in the posterior kidney, with *blimp1*, the B cell differentiation marker being most strongly up-regulated [34]. However, no significant up-regulation was observed at 12°C, indicating that B cell activation in response to pathogens may be impaired at low temperatures. Additionally, a significant increase in posterior kidney IgM<sup>+</sup> B cells was observed at seven weeks post-infection at 15°C relative to 12°C. Similar findings in another study showed that in response to infection with *Aeromonas salmonicida*, the increase in the percentage of B cells in the spleen and the blood was larger and happened more rapidly at 16°C compared to 11°C, which suggests that B lymphocyte proliferation may also be impaired under these conditions [31].

Of note is the potential impact of rapid, large temperature decreases on B lymphocytes and the teleost immune system as a whole. A drop in temperature from 25°C to 16°C over 3 h resulted in a significant reduction in the percentage of B cells in the spleen and blood of the common carp, that recovered after 24 h [32]. An increase in annexin V-positive B cells in the blood was observed immediately following the temperature shock, implying that there may be a reduction in circulating B cells in response to acute stress. While water temperature fluctuations in the wild do not occur as quickly as the changes used in these experiments, it is important to be aware of the potential for large temperature decreases to act as short-term stressors and immunosuppressors in both *in vivo* and *in vitro* studies.

### 3.3. T Lymphocytes

Suboptimal temperature effects on T cells have been most thoroughly studied in the channel catfish. Similar to B cell studies, T cell proliferation in response to the T cell mitogen concanavalin A was inhibited, and the number of T cells in the blood were decreased when PBLs were isolated from fish maintained at 11°C compared to 24°C [79]. However, unlike in B cells, peak T-cell proliferation in PBLs stimulated with concanavalin A was proportional to temperature, and was greatly reduced at 22°C relative to 27°C and 32°C [78]. Furthermore, mixed leukocyte reactions using PBLs from 24°C-acclimated fish were also temperature-dependent with respect to time, with the fastest reaction occurring at 27°C, and the slowest at 17°C [81]. In a later study, monocyte cell lines pulsed with antigen at 11°C, 17°C, or 27°C were able to induce proliferation of autologous responder T cells from PBLs, although peak proliferation was again delayed at the lower temperatures [82]. An increase in antigen-presenting cell-associated radioactivity due to uptake of radiolabelled antigen was observed at all temperatures, suggesting that the observed suppression of T cell responses at the suboptimal temperatures was not due to impaired antigen presentation by the antigen-presenting cells. Further studies attempted to explain the differential effects of low temperature on the magnitude of channel catfish T and B cell proliferation through the study of fatty acids in these cells. As seen in B cells, unsaturated fatty acid levels in the plasma membrane of T cells were increased at 17°C versus 24°C [80]. However, B cells appear to be able to synthesize oleic acid endogenously from stearic acid while T cells cannot, and accumulate stearic acid in their membranes which decreases membrane fluidity. This difference may explain the different effects of low temperatures on lymphocyte proliferation [83]. Following addition of exogenous oleic acid to T cells, 60% of the proliferation response to concanavalin A was recovered at the lower temperature, further supporting this idea [83].

Inhibitory effects of suboptimal temperatures have also been observed in other fishes, often resulting in decreases in T cell activation and activity. For example, T lymphocyte proliferation in PBLs appears to be proportional to temperature in the common carp, with proliferation increasing from 12°C to 20°C to 28°C both *in vivo* and *in vitro* [38]. Additionally, in the ginbuna crucian carp, cell-mediated cytotoxicity, believed to be due to specific cytotoxic T cells, was more efficient when cells were cultured at 25°C versus 20°C or 15°C, suggesting that this process may also be temperature-dependent [84]. However, while specific cell-mediated cytotoxicity was downregulated at 9°C versus 18°C in the common carp, a decrease in activity was also observed at 26°C, which may act as a nonpermissive higher temperature for carp [85]. Macrophage activating factor, now known as interferon gamma (IFN- $\gamma$ ), production from T cells in rainbow trout head-kidney leukocytes was lower in cells held at 6°C compared to 10°C and 18°C, although supernatants from each temperature condition were still able to significantly affect the respiratory burst activity of macrophages [42]. Interestingly, when leucocytes were collected from fish acclimated to 6°C and then allowed to acclimate for 48 h to the higher assay temperatures, some of the IFN- $\gamma$  activity could be recovered, indicating that detrimental effects of suboptimal temperatures on T cells may be reversible. Overall, these data seem to suggest that suboptimal temperatures negatively impact T cell proliferation and activity in fish, which may adversely affect their ability to limit the spread of infection and mediate specific responses against pathogens.

Polarization of helper T ( $T_H$ ) cells results in the induction of  $T_H1$  and  $T_H2$  cells, which mediate type I and type II immunity respectively [86].  $T_H1$  cells mediate macrophage activation and enhanced cytotoxic T cell activity, important for responding to intracellular bacteria, while  $T_H2$  cells are important effector cells against extracellular parasites due to their ability to activate mast cells and eosinophils. There is some experimental evidence that suboptimal temperatures may affect the polarization process in rainbow trout. Following exposure to *Tetracapsuloides bryosalmonae*,  $T_H1$  associated genes were mildly upregulated at the cold-stress temperature of 12°C in rainbow trout kidney leukocytes, while  $T_H2$  associated genes were not [34]. However, both sets of genes remained upregulated for 2 weeks post-exposure at the control temperature of 15°C. By 6 weeks post-exposure, only the  $T_H2$  associated gene expression was still increased, indicating that suboptimal temperatures may be able to impact immune response polarization.

### 3.4. Antibodies and the Humoral Response

Suboptimal temperature impacts on antibody production have been reported in numerous fish species, with B cell responses to T-dependent antigens affected more appreciably. In channel catfish, the magnitude of the peak response of IgM secreting cells isolated from PBLs was only proportional to the assay temperature for dinitrophenol (DNP) conjugated to keyhole limpet hemocyanin (KLH), a T-dependent antigen, and was temperature-independent for the T-independent antigen, trinitrophenol-LPS [82,87]. Additionally, the peak response was delayed for both antigens as the temperature decreased, with the largest delay occurring at 17°C versus 22°C, 27°C, or 32°C. A similar observation was seen in carp, as antibody production in response to DNP-KLH was proportional to temperature, with antibody levels at 12°C significantly lower than at 20°C or 28°C [37]. However, this pattern of temperature effects on antibody production is not always observed. For example, following an *in vivo* drop in temperature from 25°C to 16°C over 3 h, decreases in antibody production in response to both DNP-KLH, and trinitrophenol-LPS were observed [32]. Additionally, mucosal immunoglobulin production in channel catfish after bath vaccination with DNP-KLH was suppressed at the warmer temperature of 30°C compared to 23°C and 15°C, in contrast to the serum immunoglobulin response [88]. These studies suggest that the effect of low temperatures on the ability of fish to produce antibodies against T-dependent antigens may be greater than it is for T-independent antigens, except perhaps in the cases of rapid, large temperature reductions and mucosal responses.

Natural antibodies are important mediators of nonspecific immunity that help provide protection against pathogens, and are found at high levels in fish serum [19]. Basal serum levels of these antibodies appear to be differentially affected in different fish species by low temperatures. In rainbow trout, serum immunoglobulin levels in the summer were higher than in the winter in fish larger than 1 kg from the same fish farm, with mean seasonal temperatures of 19°C and 7°C respectively [6]. Conversely, no differences in basal plasma IgM levels were observed in tilapia maintained at 25°C or 12°C over 15 days, although perhaps differences in basal plasma IgM levels would have been observed over a longer time interval [89]. More data is needed to determine the effect of environmental temperature decreases on basal immunoglobulin levels, although current results indicate that the outcome is species-dependent.

Suboptimal temperature impacts on antibody production in response to live or inactivated pathogens and vaccines is also varied, although generally suppressive. Following infection with *Ichthyophthirius multifiliis*, serum antibody levels in channel catfish were significantly higher at 25°C and 30°C relative to 15°C and 20°C, with no detectable specific antibodies after 21 days at 15°C [90]. Additionally, serum antibody titres following injection of inactivated *Yersinia ruckeri* or phosphate-buffered saline were also temperature-dependent, with the lowest titres observed at 5°C versus 15°C and 25°C, indicating that humoral responses against inactivated pathogens, as well as in response to injection, are suppressed by cold temperatures [28]. A similar result was observed in rainbow trout when a DNA vaccine against VHSV was employed. A higher serum antibody titre was observed at 15°C than at 10°C, and no detectable antibodies were present at 5°C [91].

Furthermore, the population percentage survival upon subsequent exposure to the virus was also temperature-dependent, suggesting that vaccination efficiency may be decreased at lower temperatures. However, production of specific antibodies to inactivated *Aeromonas salmonicida* appeared to be delayed at the normal temperature of 15°C compared to 12°C in rainbow trout, with both reaching similar levels by 90 days post stimulation, showing that the effects of suboptimal temperatures are not universally similar [31]. Overall, these data indicate that the effects of suboptimal temperatures on antibody production in response to live or inactivated pathogens and vaccines is generally suppressive, potentially compromising the ability of the fish to clear infections effectively at these temperatures.

#### 4. Concluding Remarks and Future Challenges

The effect of environmental temperature on teleost immune systems thus varies depending upon the duration and magnitude of the temperature change and the fish species examined, since teleosts have adapted to a wide variety of environmental temperatures. In general, lower temperatures lead to a shutdown or slowing of immune response mechanisms, which is generally reversible upon return to warmer temperatures, suggestive of overwintering strategies. Components of the innate immune system had varied responses to cold stress, with the enhancing of innate cellular components potentially providing partial compensation for deficiencies in adaptive immunity, as there was a somewhat consistent suppression of the adaptive immune system in response to colder temperatures. This suppression could be linked to some of the detrimental impacts of low temperatures on other aspects of the innate immune system, as they are required to induce adaptive immunity. These effects could lead to a decreased ability of fishes to respond to pathogens over the winter months or in response to temperature decreases, negatively impacting their health. However, this tradeoff may be energetically favorable to the fish host at low temperatures, comparable to the diminished immune responses seen in hibernating mammals [92], and this may be why the effects of cold temperatures on the immune system appear to be generally conserved.

There are a number of challenges in attempting to study the effects of suboptimal temperatures on the teleost immune system. The use of different model systems with different thermal optimums and preferences makes it challenging to compare the magnitude of temperature decreases in different experiments, as a change as small as 3°C may negatively impact one fish species, and yet have no effect on many others. Additionally, the acclimation conditions can vary quite significantly, ranging from rapid large temperature decreases to rearing fish at a specific temperature for a period of months. Hence, it is not surprising that while rapid decreases in temperature appear to be overwhelmingly detrimental, fish subjected to long-term acclimation generally appear to be somewhat better adapted to deal with cold temperatures. Another important consideration is the assay temperature employed, as a number of studies focusing on different immune parameters have reported that peak response activity is observed when assay temperature equals fish acclimation temperature. However, this aspect is often unreported in the literature, making it challenging to fully comprehend the results of such studies. While some of these discrepancies are tougher to address practically than others, it is important that future studies attempt to take them into account to try to make it easier to compare different experimental studies.

A final consideration for future studies is the value of taking more holistic experimental approaches. While basal levels of immune components are important for dealing with initial pathogen interaction, inducible elements are equally important and necessary for clearance of infectious agents, yet these two facets are not often examined in the same study. Additionally, the virulence of pathogens is also impacted by temperature [18], although it can be difficult to tease apart these effects from those on the host immune system. Notwithstanding, it is important to acknowledge the potential value in performing more intensive and comprehensive studies that can strengthen our understanding of the impact of low environmental temperatures on host-pathogen systems, specifically in elucidating the underlying immune mechanisms that result in host mortality when fishes are exposed to acute or chronic cold stress.



**Acknowledgments:** This work was supported through Natural Sciences and Engineering Research Council of Canada Discovery Grant (NSERC DG) to Barbara A. Katzenback, a Canada Research Council Research Chair and NSERC DG to Brian Dixon and a Graduate Teaching Assistantship from the Department of Biology at University of Waterloo to Quinn H. Abram.

**Author Contributions:** All authors wrote the manuscript and have read and approved the final manuscript.

**Conflicts of Interest:** The authors declare no conflicts of interest.

## References

1. Tingley, M.P.; Huybers, P. Recent temperature extremes at high northern latitudes unprecedented in the past 600 years. *Nature* **2013**, *496*, 201–205. [[CrossRef](#)] [[PubMed](#)]
2. IPCC (Intergovernmental Panel on Climate Change). *Managing the Risks of Extreme Events and Disasters to Advance Climate Change Adaptation*; Cambridge University Press: Cambridge, UK, 2012.
3. Pirhalla, D.E.; Sheridan, S.C.; Ransibrahmanakul, V.; Lee, C.C. Assessing cold-snap and mortality events in south Florida coastal ecosystems: Development of a biological cold stress index using satellite SST and weather pattern forcing. *Estuar. Coast* **2015**, *38*, 2310–2322. [[CrossRef](#)]
4. Jain, K.E.; Farrell, A.P. Influence of seasonal temperature on the repeat swimming performance of rainbow trout *Oncorhynchus mykiss*. *J. Exp. Biol.* **2003**, *206*, 3569–3579. [[CrossRef](#)] [[PubMed](#)]
5. Lopez-Olmeda, J.F.; Sanchez-Vazquez, F.J. Thermal biology of zebrafish (*Danio rerio*). *J. Therm. Biol.* **2011**, *36*, 91–104. [[CrossRef](#)]
6. Sanchez, C.; Babin, M.; Tomillo, J.; Ubeira, F.M.; Dominguez, J. Quantification of low levels of rainbow trout immunoglobulin by enzyme immunoassay using two monoclonal antibodies. *Vet. Immunol. Immunopathol.* **1993**, *36*, 65–74. [[CrossRef](#)]
7. Bowden, T.J. Modulation of the immune system of fish by their environment. *Fish Shellfish Immunol.* **2008**, *25*, 373–383. [[CrossRef](#)] [[PubMed](#)]
8. Le Morvan, C.; Troutaud, D.; Deschaux, P. Differential effects of temperature on specific and nonspecific immune defences in fish. *J. Exp. Biol.* **1998**, *201*, 165–168. [[PubMed](#)]
9. Dominguez, M.; Takemura, A.; Tsuchiya, M.; Nakamura, S. Impact of different environmental factors on the circulating immunoglobulin levels in the Nile tilapia, *Oreochromis niloticus*. *Aquaculture* **2004**, *241*, 491–500. [[CrossRef](#)]
10. Magnadottir, B.; Jonsdottir, H.; Helgason, S.; Bjornsson, B.; Jorgensen, T.O.; Pilstrom, L. Humoral immune parameters in Atlantic cod (*Gadus morhua* L.) I. The effects of environmental temperature. *Comp Biochem. Physiol. B Biochem. Mol. Biol.* **1999**, *122*, 173–180. [[CrossRef](#)]
11. Moran, J.D.W.; Kent, M.L.; Whitaker, D.J. *Kudoa thyrsites* (Myxozoa: Myxosporidia) infection in pen-reared Atlantic salmon in the northeast Pacific Ocean with a survey of potential nonsalmonid reservoir hosts. *J. Aquat. Anim. Health* **1998**, *11*, 101–109. [[CrossRef](#)]
12. Avunje, S.; Oh, M.J.; Jung, S.J. Impaired TLR2 and TLR7 response in olive flounder infected with viral haemorrhagic septicaemia virus at host susceptible 15 °C but high at non-susceptible 20 °C. *Fish Shellfish Immunol.* **2013**, *34*, 1236–1243. [[CrossRef](#)] [[PubMed](#)]
13. Ndong, D.; Chen, Y.Y.; Lin, Y.H.; Vaseeharan, B.; Chen, J.C. The immune response of tilapia *Oreochromis mossambicus* and its susceptibility to *Streptococcus iniae* under stress in low and high temperatures. *Fish Shellfish Immunol.* **2007**, *22*, 686–694. [[CrossRef](#)] [[PubMed](#)]
14. Cheng, A.C.; Cheng, S.A.; Chen, Y.Y.; Chen, J.C. Effects of temperature change on the innate cellular and humoral immune responses of orange-spotted grouper *Epinephelus coioides* and its susceptibility to *Vibrio alginolyticus*. *Fish Shellfish Immunol.* **2009**, *26*, 768–772. [[CrossRef](#)] [[PubMed](#)]
15. Sanders, G.E.; Batts, W.N.; Winton, J.R. Susceptibility of zebrafish (*Danio rerio*) to a model pathogen, spring viremia of carp virus. *Comp. Med.* **2003**, *53*, 514–521. [[PubMed](#)]
16. Rovnak, J.; Quackenbush, S.L. Walleye dermal sarcoma virus: Molecular biology and oncogenesis. *Viruses* **2010**, *2*, 1984–1999. [[CrossRef](#)] [[PubMed](#)]
17. Bowser, P.R.; Wolfe, M.J.; Forney, J.L.; Wooster, G.A. Seasonal prevalence of skin tumors from walleye (*Stizostedion vitreum*) from Oneida Lake, New York. *J. Wildlife Dis.* **1988**, *24*, 292–298. [[CrossRef](#)] [[PubMed](#)]
18. Guijarro, J.A.; Cascales, D.; Garcia-Torrico, A.I.; Garcia-Domiguez, M.; Mendez, J. Temperature-dependent expression of virulence genes in fish-pathogenic bacteria. *Front. Microbiol.* **2015**, *9*, 700. [[CrossRef](#)] [[PubMed](#)]

19. Uribe, C.; Folch, H.; Enriquez, R.; Moran, G. Innate and adaptive immunity in teleost fish: A review. *Vet. Med.* **2011**, *56*, 486–503.
20. Zhu, L.Y.; Nie, L.; Zhu, G.; Xiang, L.X.; Shao, J.Z. Advances in research of fish immune-relevant genes: A comparative overview of innate and adaptive immunity in teleosts. *Dev. Comp. Immunol.* **2013**, *39*, 39–62. [[CrossRef](#)] [[PubMed](#)]
21. Katzenback, B.A. Antimicrobial peptides as mediators of innate immunity in teleosts. *Biology* **2015**, *4*, 607–639. [[CrossRef](#)] [[PubMed](#)]
22. Havixbeck, J.J.; Barreda, D.R. Neutrophil development, migration, and function in teleost fish. *Biology* **2015**, *4*, 715–734. [[CrossRef](#)] [[PubMed](#)]
23. Hodgkinson, J.W.; Grayfer, L.; Belosevic, M. Biology of bony fish macrophages. *Biology* **2015**, *4*, 881–906. [[CrossRef](#)] [[PubMed](#)]
24. Nakao, M.; Tsujikura, M.; Ichiki, S.; Vo, T.K.; Somamoto, T. The complement system in teleost fish: Progress of post-homolog-hunting researches. *Dev. Comp. Immunol.* **2011**, *35*, 1296–1308. [[CrossRef](#)] [[PubMed](#)]
25. Chebaani, N.; Guardiola, F.A.; Sihem, M.; Nabil, A.; Oumouna, M.; Meseguer, J.; Esteban, M.A.; Cuesta, A. Innate humoral immune parameters in *Tilapia zillii* under acute stress by low temperature and crowding. *Fish Physiol. Biochem.* **2014**, *40*, 797–804. [[CrossRef](#)] [[PubMed](#)]
26. Nikoskelainen, S.; Bylund, G.; Lilius, E.M. Effect of environmental temperature on rainbow trout (*Oncorhynchus mykiss*) innate immunity. *Dev. Comp. Immunol.* **2004**, *28*, 581–592. [[CrossRef](#)] [[PubMed](#)]
27. Alcorn, S.W.; Murra, A.L.; Pascho, R.J. Effects of rearing temperature on immune functions in sockeye salmon (*Oncorhynchus nerka*). *Fish Shellfish Immunol.* **2002**, *12*, 303–334. [[CrossRef](#)] [[PubMed](#)]
28. Raida, M.K.; Buchmann, K. Temperature-dependent expression of immune-relevant genes in rainbow trout following *Yersinia ruckeri* vaccination. *Dis. Aquat. Org.* **2007**, *77*, 41–52. [[CrossRef](#)] [[PubMed](#)]
29. Langston, A.L.; Hoare, R.; Stefansson, M.; Fitzgerald, R.; Wergeland, H.; Mulcahy, M. The effect of temperature on non-specific defence parameters of three strains of juvenile Atlantic halibut (*Hippoglossus hippoglossus* L.). *Fish Shellfish Immunol.* **2002**, *12*, 61–76. [[CrossRef](#)] [[PubMed](#)]
30. Ainsworth, A.J.; Dexiang, C.; Waterstrat, P.R.; Greenway, T. Effect of temperature on the immune system of channel catfish (*Ictalurus punctatus*)—I. Leucocyte distribution and phagocyte function in the anterior kidney at 10 degrees C. *Comp. Biochem. Physiol. A Comp. Physiol.* **1991**, *100*, 907–912. [[CrossRef](#)]
31. Kollner, B.; Kotterba, G. Temperature dependent activation of leucocyte populations of rainbow trout, *Oncorhynchus mykiss*, after intraperitoneal immunisation with *Aeromonas salmonicida*. *Fish Shellfish Immunol.* **2002**, *12*, 35–48. [[CrossRef](#)] [[PubMed](#)]
32. Engelsma, M.Y.; Hougee, S.; Nap, D.; Hofenk, M.; Rombout, J.H.; van Muiswinkel, W.B.; Lidy Verburg-van Kemenade, B.M. Multiple acute temperature stress affects leucocyte populations and antibody responses in common carp, *Cyprinus carpio* L. *Fish Shellfish Immunol.* **2003**, *15*, 397–410. [[CrossRef](#)]
33. Hrubec, T.C.; Robertson, J.L.; Smith, S.A. Effects of temperature on hematologic and serum biochemical profiles of hybrid striped bass (*Morone chrysops* × *Morone saxatilis*). *Am. J. Vet. Res.* **1997**, *58*, 126–130. [[PubMed](#)]
34. Bailey, C.; Segner, H.; Casanova-Nakayama, A.; Wahli, T. Who needs the hotspot? The effect of temperature on the fish host immune response to *Tetracapsuloides bryosalmonae* the causative agent of proliferative kidney disease. *Fish Shellfish Immunol.* **2017**, *63*, 424–437. [[CrossRef](#)] [[PubMed](#)]
35. Scott, A.L.; Rogers, W.A.; Klesius, P.H. Chemiluminescence by peripheral blood phagocytes from channel catfish: Function of opsonin and temperature. *Dev. Comp. Immunol.* **1985**, *9*, 241–250. [[CrossRef](#)]
36. Kurata, O.; Okamoto, N.; Suzumura, E.; Sano, N.; Ikeda, Y. Accommodation of carp natural killer-like cells to environmental temperatures. *Aquaculture* **1995**, *129*, 421–424. [[CrossRef](#)]
37. Le Morvan, C.; Deschaux, P.; Troutaud, D. Effects and mechanisms of environmental temperature on carp (*Cyprinus carpio*) anti-DNP antibody response and non-specific cytotoxic cell activity: A kinetic study. *Dev. Comp. Immunol.* **1996**, *20*, 331–340. [[CrossRef](#)]
38. Le Morvan-Rocher, C.; Troutaud, D.; Deschaux, P. Effects of temperature on carp leukocyte mitogen-induced proliferation and nonspecific cytotoxic activity. *Dev. Comp. Immunol.* **1995**, *19*, 87–95. [[CrossRef](#)]
39. Katzenback, B.A.; Belosevic, M. Isolation and functional characterization of neutrophil-like cells, from goldfish (*Carassius auratus* L.) kidney. *Dev. Comp. Immunol.* **2009**, *33*, 601–611. [[CrossRef](#)] [[PubMed](#)]

40. Hodgkinson, J.W.; Ge, J.Q.; Katzenback, B.A.; Havixbeck, J.J.; Barreda, D.R.; Stafford, J.L.; Belosevic, M. Development of an *in vitro* model system to study the interactions between *Mycobacterium marinum* and teleost neutrophils. *Dev. Comp. Immunol.* **2015**, *53*, 349–357. [[CrossRef](#)] [[PubMed](#)]
41. Belosevic, M.; Haddad, G.; Walsh, J.G.; Grayfer, L.; Katzenback, B.A.; Hanington, P.C.; Neumann, N.F.; Stafford, J.L. Innate Immunity of Fish: Antimicrobial Responses of Fish Macrophages. In *Fish Defenses*; Zaccane, G., Manning, M.J., Secombes, C.J., Kapor, B.G., Eds.; Science Publishers: Enfield, NH, USA; Plymouth, UK, 2007; Volume 1.
42. Hardie, L.J.; Fletcher, T.C.; Secombes, C.J. Effect of temperature on macrophage activation and the production of macrophage activating factor by rainbow trout (*Oncorhynchus mykiss*) leucocytes. *Dev. Comp. Immunol.* **1994**, *18*, 57–66. [[CrossRef](#)]
43. Sohnle, P.G.; Chusid, M.J. The effect of temperature on the chemiluminescence response of neutrophils from rainbow trout and man. *J. Comp. Pathol.* **1983**, *93*, 493–497. [[CrossRef](#)]
44. LeMorvan, C.; Clerton, P.; Deschaux, P.; Troutaud, D. Effects of environmental temperature on macrophage activities in carp. *Fish Shellfish Immunol.* **1997**, *7*, 209–212. [[CrossRef](#)]
45. Collazos, M.E.; Ortega, E.; Barriga, C. Effect of temperature on the immune system of a cyprinid fish (*Tinca Tinca*, L)—Blood phagocyte function at low-temperature. *Fish Shellfish Immunol.* **1994**, *4*, 231–238. [[CrossRef](#)]
46. Dios, S.; Romero, A.; Chamorro, R.; Figueras, A.; Novoa, B. Effect of the temperature during antiviral immune response ontogeny in teleosts. *Fish Shellfish Immunol.* **2010**, *29*, 1019–1027. [[CrossRef](#)] [[PubMed](#)]
47. Sundaram, A.Y.M.; Consuegra, S.; Kiron, V.; Fernandes, J.M.O. Positive selection pressure within teleost toll-like receptors tlr21 and tlr22 subfamilies and their response to temperature stress and microbial components in zebrafish. *Mol. Biol. Rep.* **2012**, *39*, 8965–8975. [[CrossRef](#)] [[PubMed](#)]
48. Salinas, I.; Lockhart, K.; Bowden, T.J.; Collet, B.; Secombes, C.J.; Ellis, A.E. An assessment of immunostimulants as Mx inducers in Atlantic salmon (*Salmo salar* L.) parr and the effect of temperature on the kinetics of Mx responses. *Fish Shellfish Immunol.* **2004**, *17*, 159–170. [[CrossRef](#)] [[PubMed](#)]
49. Kulkeaw, K.; Ishitani, T.; Kanemaru, T.; Fucharoen, S.; Sugiyama, D. Cold exposure down-regulates zebrafish hematopoiesis. *Biochem. Biophys. Res. Commun.* **2010**, *394*, 859–864. [[CrossRef](#)] [[PubMed](#)]
50. Katakura, F.; Katzenback, B.A.; Belosevic, M. Molecular and functional characterization of erythropoietin of the goldfish (*Carassius auratus* L.). *Dev. Comp. Immunol.* **2013**, *40*, 148–157. [[CrossRef](#)] [[PubMed](#)]
51. Katakura, F.; Katzenback, B.A.; Belosevic, M. Molecular and functional characterization of erythropoietin receptor of the goldfish (*Carassius auratus* L.). *Dev. Comp. Immunol.* **2014**, *45*, 191–198. [[CrossRef](#)] [[PubMed](#)]
52. Katzenback, B.A.; Katakura, F.; Belosevic, M. Goldfish (*Carassius auratus* L.) as a model system to study the growth factors, receptors and transcription factors that govern myelopoiesis in fish. *Dev. Comp. Immunol.* **2016**, *58*, 68–85. [[CrossRef](#)] [[PubMed](#)]
53. Katzenback, B.A.; Belosevic, M. Colony-stimulating factor-1 receptor protein expression is a specific marker for goldfish (*Carassius auratus* L.) macrophage progenitors and their differentiated cell types. *Fish Shellfish Immunol.* **2012**, *32*, 434–445. [[CrossRef](#)] [[PubMed](#)]
54. Katzenback, B.A.; Belosevic, M. Characterization of granulocyte colony stimulating factor receptor of the goldfish (*Carassius auratus* L.). *Dev. Comp. Immunol.* **2012**, *36*, 199–207. [[CrossRef](#)] [[PubMed](#)]
55. Katzenback, B.A.; Katakura, F.; Belosevic, M. Regulation of Teleost Macrophage and Neutrophil Cell Development by Growth Factors and Transcription Factors. In *New Advances and Contributions to Fish Biology*; Turker, H., Ed.; In Tech: Rijeka, Croatia, European Union, 2012; p. 54.
56. Zou, J.; Holland, J.; Pleguezuelos, O.; Cunningham, C.; Secombes, C.J. Factors influencing the expression of interleukin-1 beta in cultured rainbow trout (*Oncorhynchus mykiss*) leucocytes. *Dev. Comp. Immunol.* **2000**, *24*, 575–582. [[CrossRef](#)]
57. Thanasaksiri, K.; Sakai, N.; Yamashita, H.; Hirono, I.; Kondo, H. Influence of temperature on Mx gene expression profiles and the protection of sevenband grouper, *Epinephelus septemfasciatus*, against red-spotted grouper nervous necrosis virus (RGNNV) infection after poly (I:C) injection. *Fish Shellfish Immunol.* **2014**, *40*, 441–445. [[CrossRef](#)] [[PubMed](#)]
58. Raida, M.K.; Buchmann, K. Bath vaccination of rainbow trout (*Oncorhynchus mykiss* Walbaum) against *Yersinia ruckeri*: Effects of temperature on protection and gene expression. *Vaccine* **2008**, *26*, 1050–1062. [[CrossRef](#)] [[PubMed](#)]

59. Ebstein, F.; Kloetzel, P.M.; Kruger, E.; Seifert, U. Emerging roles of immunoproteasomes beyond MHC class I antigen processing. *Cell. Mol. Life Sci.* **2012**, *69*, 2543–2558. [[CrossRef](#)] [[PubMed](#)]
60. Apcher, S.; Manoury, B.; Fahraeus, R. The role of mRNA translation in direct MHC class I antigen presentation. *Curr. Opin. Immunol.* **2012**, *24*, 71–76. [[CrossRef](#)] [[PubMed](#)]
61. Shastri, N.; Cardinaud, S.; Schwab, S.R.; Serwold, T.; Kunisawa, J. All the peptides that fit: The beginning, the middle, and the end of the MHC class I antigen-processing pathway. *Immunol. Rev.* **2005**, *207*, 31–41. [[CrossRef](#)] [[PubMed](#)]
62. Mantegazza, A.R.; Magalhaes, J.G.; Amigorena, S.; Marks, M.S. Presentation of phagocytosed antigens by MHC class I and II. *Traffic* **2013**, *14*, 135–152. [[CrossRef](#)] [[PubMed](#)]
63. Rodrigues, P.N.; Dixon, B.; Roelofs, J.; Rombout, J.H.; Egberts, E.; Pohajdak, B.; Stet, R.J. Expression and temperature-dependent regulation of the beta2-microglobulin (Cyca-B2m) gene in a cold-blooded vertebrate, the common carp (*Cyprinus carpio* L.). *Dev. Immunol.* **1998**, *5*, 263–275. [[CrossRef](#)] [[PubMed](#)]
64. Kales, S.; Parks-Dely, J.; Schulte, P.; Dixon, B. Beta-2-microglobulin gene expression is maintained in rainbow trout and Atlantic salmon kept at low temperatures. *Fish Shellfish Immunol.* **2006**, *21*, 176–186. [[CrossRef](#)] [[PubMed](#)]
65. Sever, L.; Vo, N.T.; Lumsden, J.; Bols, N.C.; Dixon, B. Induction of rainbow trout MH class I and accessory proteins by viral haemorrhagic septicaemia virus. *Mol. Immunol.* **2014**, *59*, 154–162. [[CrossRef](#)] [[PubMed](#)]
66. Nath, S.; Kales, S.; Fujiki, K.; Dixon, B. Major histocompatibility class II genes in rainbow trout (*Oncorhynchus mykiss*) exhibit temperature dependent downregulation. *Immunogenetics* **2006**, *58*, 443–453. [[CrossRef](#)] [[PubMed](#)]
67. Hansen, J.D.; Strassburger, P.; Du Pasquier, L. Conservation of an alpha 2 domain within the teleostean world, MHC class I from the rainbow trout *Oncorhynchus mykiss*. *Dev. Comp. Immunol.* **1996**, *20*, 417–425. [[CrossRef](#)]
68. Hansen, J.D.; Strassburger, P.; Thorgaard, G.H.; Young, W.P.; Du Pasquier, L. Expression, linkage, and polymorphism of MHC-related genes in rainbow trout, *Oncorhynchus mykiss*. *J. Immunol.* **1999**, *163*, 774–786. [[PubMed](#)]
69. Sever, L.; Vo, N.; Bols, N.C.; Dixon, B. Expression of tapasin in rainbow trout tissues and cell lines and up regulation in a monocyte/macrophage cell line (RTS11) by a viral mimic and viral infection. *Dev. Comp. Immunol.* **2014**, *44*, 86–93. [[CrossRef](#)] [[PubMed](#)]
70. Kales, S.; Fujiki, K.; Dixon, B. Molecular cloning and characterization of calreticulin from rainbow trout (*Oncorhynchus mykiss*). *Immunogenetics* **2004**, *55*, 717–723. [[CrossRef](#)] [[PubMed](#)]
71. Kales, S.C.; Bols, N.C.; Dixon, B. Calreticulin in rainbow trout: A limited response to endoplasmic reticulum (ER) stress. *Comp. Biochem. Physiol. B Biochem. Mol. Biol.* **2007**, *147*, 607–615. [[CrossRef](#)] [[PubMed](#)]
72. Sever, L.; Bols, N.C.; Dixon, B. The cloning and inducible expression of the rainbow trout ERp57 gene. *Fish Shellfish Immunol.* **2013**, *34*, 410–419. [[CrossRef](#)] [[PubMed](#)]
73. Sever, L.; Vo, N.; Bols, N.C.; Dixon, B. Rainbow trout (*Oncorhynchus mykiss*) contain two Calnexin genes which encode distinct proteins. *Dev. Comp. Immunol.* **2014**, *42*, 211–219. [[CrossRef](#)] [[PubMed](#)]
74. Semple, S.L.; Vo, N.T.K.; Li, A.R.; Pham, P.H.; Bols, N.C.; Dixon, B. Development and use of an Arctic charr cell line to study antiviral responses at extremely low temperatures. *J. Fish Dis.* **2017**, *40*, 1423–1439. [[CrossRef](#)] [[PubMed](#)]
75. Nakanishi, T.; Shibasaki, Y.; Matsuura, Y. T cells in fish. *Biology* **2015**, *4*, 640–663. [[CrossRef](#)] [[PubMed](#)]
76. Mashoof, S.; Criscitiello, M.F. Fish immunoglobulins. *Biology* **2016**, *5*, 45. [[CrossRef](#)] [[PubMed](#)]
77. Salinas, I.; Zhang, Y.A.; Sunyer, J.O. Mucosal immunoglobulins and B cells of teleost fish. *Dev. Comp. Immunol.* **2011**, *35*, 1346–1365. [[CrossRef](#)] [[PubMed](#)]
78. Clem, L.W.; Faulmann, E.; Miller, N.W.; Ellsaesser, C.; Lobb, C.J.; Cuchens, M.A. Temperature-mediated processes in teleost immunity: Differential effects of *in vitro* and *in vivo* temperatures on mitogenic responses of channel catfish lymphocytes. *Dev. Comp. Immunol.* **1984**, *8*, 313–322. [[CrossRef](#)]
79. Bly, J.E.; Clem, L.W. Temperature-mediated processes in teleost immunity: *In Vitro* immunosuppression induced by *in vivo* low temperature in channel catfish. *Vet. Immunol. Immunopathol.* **1991**, *28*, 365–377. [[CrossRef](#)]
80. Bly, J.E.; Buttke, T.M.; Meydrech, E.F.; Clem, L.W. The effects of *in vivo* acclimation temperature on the fatty acid composition of channel catfish (*Ictalurus punctatus*) peripheral blood cells. *Comp. Biochem. Phys. B Comp. Biochem.* **1986**, *83*, 791–795. [[CrossRef](#)]

81. Miller, N.W.; Deuter, A.; Clem, L.W. Phylogeny of lymphocyte heterogeneity: The cellular requirements for the mixed leucocyte reaction with channel catfish. *Immunology* **1986**, *59*, 123–128. [[PubMed](#)]
82. Vallejo, A.N.; Miller, N.W.; Clem, L.W. Cellular pathway(s) of antigen processing in fish APC: Effect of varying *in vitro* temperatures on antigen catabolism. *Dev. Comp. Immunol.* **1992**, *16*, 367–381. [[CrossRef](#)]
83. Bly, J.E.; Buttke, T.M.; Clem, L.W. Differential effects of temperature and exogenous fatty acids on mitogen-induced proliferation in channel catfish T and B lymphocytes. *Comp. Biochem. Physiol. A Comp. Physiol.* **1990**, *95*, 417–424. [[CrossRef](#)]
84. Fischer, U.; Ototake, M.; Nakanishi, T. Effect of environmental temperature on *in vitro* cell-mediated cytotoxicity (CMC) and graft-versus-host reaction (GVHR) in ginbuna crucian carp (*Carassius auratus langsdorfii*). *Fish Shellfish Immunol.* **1999**, *9*, 233–236. [[CrossRef](#)]
85. Verlhac, V.; Sage, M.; Deschaux, P. Cytotoxicity of carp (*Cyprinus carpio*) leucocytes induced against TNP-modified autologous spleen cells and influence of acclimatization temperature. *Dev. Comp. Immunol.* **1990**, *14*, 475–480. [[CrossRef](#)]
86. Yamaguchi, T.; Takizawa, F.; Fischer, U.; Dijkstra, J.M. Along the axis between type 1 and type 2 immunity; principles conserved in evolution from fish to mammals. *Biology* **2015**, *4*, 814–859. [[CrossRef](#)] [[PubMed](#)]
87. Miller, N.W.; Clem, L.W. Temperature-mediated processes in teleost immunity: Differential effects of temperature on catfish *in vitro* antibody responses to thymus-dependent and thymus-independent antigens. *J. Immunol.* **1984**, *133*, 2356–2359. [[PubMed](#)]
88. Lange, M.D.; Webster, C.D. The effect of temperature on the mucosal IgM antibody response to DNP-KLH in channel catfish (*Ictalurus punctatus*). *Fish Shellfish Immunol.* **2017**, *70*, 493–497. [[CrossRef](#)] [[PubMed](#)]
89. Chen, W.H.; Sun, L.T.; Tsai, C.L.; Song, Y.L.; Chang, C.F. Cold-stress induced the modulation of catecholamines, cortisol, immunoglobulin M, and leukocyte phagocytosis in tilapia. *Gen. Comp. Endocrinol.* **2002**, *126*, 90–100. [[CrossRef](#)] [[PubMed](#)]
90. Martins, M.L.; Xu, D.H.; Shoemaker, C.A.; Klesius, P.H. Temperature effects on immune response and hematological parameters of channel catfish *Ictalurus punctatus* vaccinated with live theronts of *Ichthyophthirius multifiliis*. *Fish Shellfish Immunol.* **2011**, *31*, 774–780. [[CrossRef](#)] [[PubMed](#)]
91. Lorenzen, E.; Einer-Jensen, K.; Rasmussen, J.S.; Kjaer, T.E.; Collet, B.; Secombes, C.J.; Lorenzen, N. The protective mechanisms induced by a fish rhabdovirus DNA vaccine depend on temperature. *Vaccine* **2009**, *27*, 3870–3880. [[CrossRef](#)] [[PubMed](#)]
92. Bouma, H.R.; Carey, H.V.; Kroese, F.G.M. Hibernation: The immune system at rest? *J. Leukoc. Biol.* **2010**, *88*, 619–624. [[CrossRef](#)] [[PubMed](#)]



© 2017 by the authors. Licensee MDPI, Basel, Switzerland. This article is an open access article distributed under the terms and conditions of the Creative Commons Attribution (CC BY) license (<http://creativecommons.org/licenses/by/4.0/>).

# More rapid and severe disease outbreaks for aquaculture at the tropics: implications for food security

 EXHIBIT C-1

Tommy L. F. Leung<sup>1\*</sup> and Amanda E. Bates<sup>2,3</sup>

<sup>1</sup>Centre for Behavioural and Physiological Ecology, Zoology, University of New England, Armidale, NSW, 2351, Australia ; <sup>2</sup>Institute of Marine and Antarctic Studies, University of Tasmania, PO Box 49, Taroona, TAS, 7001, Australia ; and <sup>3</sup>School of Life and Environmental Sciences, Deakin University, PO Box 432, Warrambool, Vic., 3280, Australia

## Summary

1. Aquaculture is replacing capture fisheries in supplying the world with dietary protein. Although disease is a major threat to aquaculture production, the underlying global epidemiological patterns are unknown.
2. We analysed disease outbreak severity across different latitudes in a diverse range of aquaculture systems.
3. Disease at lower latitudes progresses more rapidly and results in higher cumulative mortality, in particular at early stages of development and in shellfish.
4. Tropical countries suffer proportionally greater losses in aquaculture during disease outbreaks and have less time to mitigate losses.
5. *Synthesis and applications.* Disease can present a major problem for food production and security in equatorial regions where fish and shellfish provide a major source of dietary protein. As the incidences of some infectious diseases may increase with climate change, adaptation strategies must consider global patterns in disease vulnerability of aquaculture and develop options to minimize impacts on food production.

**Key-words:** climate change adaptation, disease, epidemiology, epizootics, latitudinal trend

## Introduction

Food security is a pressing global issue as the human population is projected to reach between 7.5 and 10.5 billion by 2050 (UNPD 2006). With capture fisheries becoming increasingly unsustainable due to overfishing, aquaculture is expected to overtake capture fisheries in supplying the world's protein requirements in the future (FAO 2012). Indeed, aquaculture is the fastest growing food production sector in the world, with an average annual growth rate of 6.3% since 2000 (average 8.8% per year between 1980 and 2010) and currently accounts for approximately 47% of the world's fish supply (FAO 2012). Although the precise impacts and direction of climate-driven change for particular fish stocks and fisheries are uncertain, in countries which depend heavily upon fisheries for their livelihood, climate change is expected to result in increased economic hardship or missed opportunities for

development (Allison *et al.* 2009). These countries are also the most vulnerable to the effects of climate change as they have the least capacity to implement adaptive actions (Dulvy *et al.* 2011). Aquaculture is expected to contribute to food security and improving the socio-economic status of developing countries (Godfray *et al.* 2010) and thus provide adaptive capacity to the effects of climate change and food shortages.

However, aquaculture may not be a panacea for food security. As in other forms of intensive and semi-intensive agriculture, infectious disease is a major problem. Waterborne pathogens can spread at faster rates than in terrestrial systems (McCallum, Harvell & Dobson 2003), and oceanographic transport processes have the potential to transmit disease across vast geographic regions, for example, pilchard herpesvirus was spread to >5000 km of Australian coastline at 30 km day<sup>-1</sup> (Whittington *et al.* 1997). In fact, infectious disease is by far the biggest killer of farmed fishes (Pillay & Kutty 2005); an outbreak can often wipe out entire stocks, requiring costly decontamination of the associated facilities and equipment (Pillay &

\*Correspondence author. E-mail: tleung6@une.edu.au

Kutty 2005), and has been identified as a potential limiting factor to aquaculture production (Jansen *et al.* 2012). The epidemiological issues associated with aquaculture will also be exacerbated by climate change (Karvonen *et al.* 2010). Extreme weather events are predicted to become more severe and more frequent in the future (IPCC 2007) favouring pathogen outbreaks following seasonal periods associated with changes in temperature and precipitation (Altizer *et al.* 2006). Additionally, increases in temperature are expected to lead to the introduction of pathogens to new regions by producing environmental conditions that favour pathogen growth and transmission (Harvell *et al.* 2002).

In spite of the expected issues with disease in aquaculture settings, the underlying global patterns in disease outbreaks have not been identified. However, in natural systems, the number of parasite or pathogen species infecting each host species tends to be higher at the lower latitudes (Rohde & Heap 1998; Guernier, Hochberg & Guegan 2004; Nunn *et al.* 2005), as well as reaching higher infection intensity (Calvete 2003; Benejam *et al.* 2009) and prevalence (Merino *et al.* 2008). Infectious disease-related mortalities are also more likely to occur at lower latitudes where relatively warmer climate promotes higher pathogen proliferation and transmission rates (Robar, Burness & Murray 2010). Thus, the ecological literature certainly suggests that similar patterns may be

present in aquacultural systems, but this has not been investigated perhaps due to the assumption that such patterns will be mitigated by disease control measures. Establishing whether macroecological patterns of infectious disease are present in farmed settings can contribute valuable insights into the environmental drivers of diseases and appropriate management procedures for outbreaks. For example, ecological theories have facilitated the development and implementation of control measures for human infectious diseases and public health policies (Smith *et al.* 2005).

The potential for disease outbreak dynamics to be mediated by changes in climate and impact food production highlights the importance of establishing the current macroecological patterns of disease outbreaks in aquaculture at a global scale. Baseline epidemiological patterns will aid predictions of future outbreak patterns and contribute to building forward thinking aquaculture infrastructure and adaptive management strategies. Here, we analysed the epidemiological pattern of disease outbreaks in aquaculture across the globe (Fig. 1a) using data from published sources on disease outbreaks that have occurred in aquaculture facilities (see Table S1, Supporting information). We quantified the severity and duration of disease outbreaks across latitude for juvenile and adult stages of various fish and invertebrate species infected by viral, bacterial and parasitic disease-causing agents. Origin

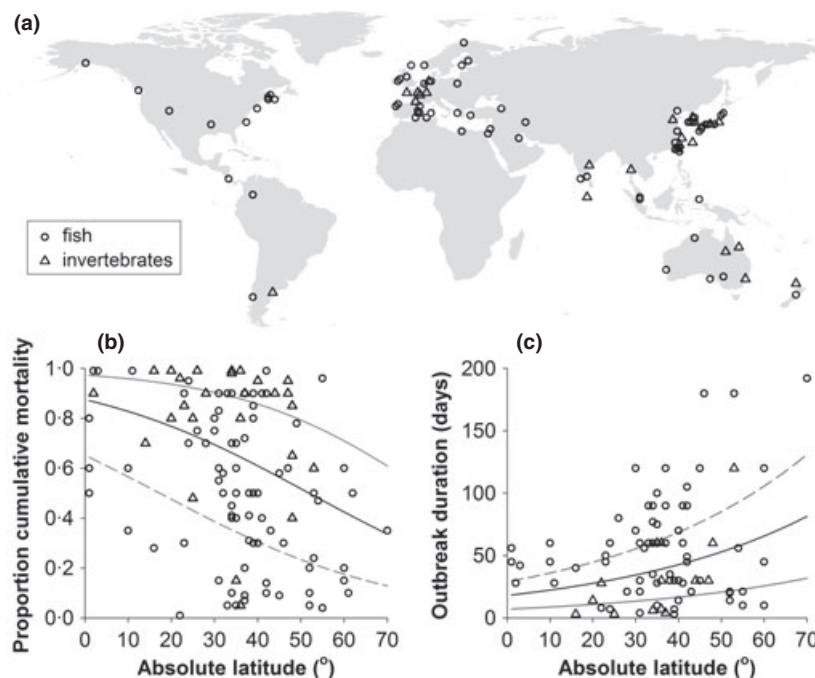

**Fig. 1.** Geographic distribution and severity of published disease outbreaks in aquaculture systems. (a) Locations of aquaculture-based disease events included in this study for fish and invertebrates. (b) Relationship between proportion cumulative mortality (total number of observations = 114) and absolute latitude resulting from disease outbreak. (c) Outbreak duration vs. absolute latitude (total number of observations = 91). Predicted relationships represent the grand mean (black line), adult fish cultured within their native range infected with a bacterial infection for total cumulative mortality, panel b, or a regional study scale, panel c (solid grey), and maximum cumulative mortality for juvenile invertebrates outside their native range with parasite infections for maximum cumulative mortality, panel b, or a local study scale, panel c (dotted grey). Predicted values are for a government efficiency index of 0.

and life stage of each host were additional explanatory factors. To account for variation in veterinary and disease reporting infrastructure, which is expected to differ between countries, we also included an index of governance efficiency that considers the quality of policy formation and implementation among other aspects of governance (The World Bank Group 2011). Finally, because cumulative mortality was reported as either a total or a maximum value and outbreak duration was for either local (e.g. tank, pond, net, single site) or regional scales (e.g. multiple farms), we also included those information as factors.

## Materials and methods

### DATA COLLECTION AND INCLUSION CRITERIA

We gathered data from published reports from peer-reviewed publications of disease-induced mortalities in commercial aquaculture facilities. All relevant studies available to either author were obtained by browsing all issues in relevant peer-reviewed journals as of 15 June 2011 (see Table S1). Additional literature searches were conducted using ISI Web of Knowledge and Google Scholar using a combination of search term 'Aquacult\*' AND 'Outbreak' OR 'Epizootic' OR 'Epidemic' OR 'Mortalit\*'. Studies reporting on the severity (number or percentage of mortalities) and/or duration of the outbreak were selected. From this set, any studies reporting intervention action that lead to significant change in mortality parameters were excluded.

Where possible, we obtained the following information from each study: maximum cumulative mortality, duration of the outbreak, latitude and longitude of outbreak location, aquaculture species, life stage, host origin and pathogen type (Table S1). We also searched for additional parameters (stocking density, rearing method, water temperature and time of year in which the outbreak occurred), but these factors were not included because we could not obtain complete data (Table S1). Disease outbreaks at larval stages, which show the same trends as adult and juveniles, tended to result in cumulative mortality >80%. However, because of low sample size, larval outbreak data are not included in analyses but appear in Table S1.

Each entry in our data set corresponds to one aquaculture species at a particular location over a single continuous period of time. Separate entries were included for each species in studies that reported mortality in more than one aquaculture species. Where multiple levels of cumulative mortalities were reported, only the maximum cumulative mortality was recorded. Pathogens were identified as a virus, bacterium or parasite. Parasites are defined as eukaryotic parasitic organisms including fungi, microsporidians, protozoans, dinoflagellates, myxosporeans, arthropods, platyhelminths and nematodes.

### STATISTICAL METHODS

We quantified the relationships between outbreak mortality and duration with absolute latitude using Linear and Generalized Linear Modelling approaches. We started with a full set of explanatory factors as fixed effects based on *a priori* hypotheses which data were available: life stage (adult vs. juvenile), taxon (fish vs. invertebrate), agent (bacterium vs. parasite vs. virus) and

host origin (non-native vs. native host). We further included government effectiveness (defined as 'perceptions of the quality of public services, the quality of the civil service and the degree of its independence from political pressures, the quality of policy formulation and implementation, and the credibility of the government's commitment to such policies'— (The World Bank Group 2011) as an indicator of governance efficiency due to the potential issue of latitudinal trends being driven by disease reporting quality (Fig. 2). Mortality metric (total vs. maximum) and study scale (local vs. regional) were also included for the responses, respectively, cumulative mortality and outbreak duration. Nested taxonomy (family/genus/species) was included as a random effect on the model intercept to account for variation in the response variable due to multiple reports of related taxa. Collinearity diagnostics (Zuur, Ieno & Elphick 2009) were performed by quantifying generalized variance inflation factors (GVIF) for each fixed factor and interactions with latitude (latitude was centred prior to the analysis) using the function *preds.GVIF* available through the R (R Development Core Team 2011) package 'car' (Fox & Weisberg 2011). We removed interaction terms with latitude from our full model because GVIF values exceeded the arbitrary threshold of 2. The interaction between latitude and taxon was excluded because the majority of outbreak data (c. 80%) were from fish.

Model selection consisted of comparing fixed- and mixed-effects models. This allowed us to assess whether including nested taxonomic levels as random effects was justified by examining the variance component explained by family, genus and species. Because the variance that could be attributed to each taxonomic level was less than 0.0001% of the overall variance, we selected among possible fixed-effects models (glm with binomial or negative binomial error structure vs. lm following transformation of the response variable), as appropriate for proportion (cumulative mortality) and count (outbreak duration) data on the basis of graphical residual analysis.

Multimodel inference produced model-averaged parameter estimates and unconditional errors using AICc for all factors included in the full model (see Tables S2, Supporting information). The candidate model set included all possible combinations

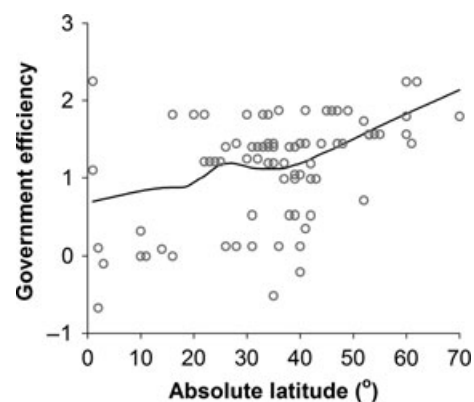

**Fig. 2.** Index of government effectiveness (World Bank Governance Indicator: The World Bank Group 2011, 'government effectiveness') vs. absolute latitude for the countries with disease outbreak reports included in Table S1. A loess smoothing curve (black line) indicates a positive relationship. Note that when latitude was removed from the model, the 95% confidence interval for government efficiency did not cross zero.



of factors (note that interactions were not included). The confidence model set included models within a 90% confidence threshold (summed weight using AICc: Burnham & Anderson 2002) with the package 'MuMIn' (Barton 2009) and the function *model.avg* (missing coefficients were set to zero).

## Results

We found that outbreak severity (in terms of cumulative mortality) was relatively higher in the tropics where outbreaks lead to an average cumulative mortality of 88% at the equator (Fig. 1b) and declined in temperate systems to 34% at 70° absolute latitude (Table 1a). Juvenile invertebrates were relatively more vulnerable in comparison with adult finfish, where at the equator, proportion

**Table 1.** Multimodel inference produced model-averaged parameter estimates, unconditional standard errors (SEu) and 95% confidence interval based on AICc for all factors included in the full model. (a) Cumulative mortality (Linear Model with logit-transformed response data) and (b) outbreak duration (Generalized Linear Model with a negative binomial error structure) as a function of two covariates: absolute latitude and governance efficiency and five factors: life stage (juvenile/adult), taxon (invertebrate/fish), origin (non-native/native), agent (parasite/virus/bacterium) and, for respectively, cumulative mortality and outbreak duration, mortality metric (maximum/total) and study scale (local/regional). The parameter estimate for 'reference' represents adult fish cultured within their native range and infected with a bacterium and, as appropriate for the response, values representing total cumulative mortality or a regional study scale (italicized above). Effect types are slope (shaded) and intercept (unshaded). Stars (\*) indicate coefficients where the 95% CI does not cross zero

<b>(a) Mortality</b>				
Fixed effects	Estimate	SEu	2.5%	97.5%
Reference	0.62	0.51	-0.39	1.63
Latitude*	-0.036	0.011	-0.057	-0.015
Governance efficiency	-0.11	0.25	-0.61	0.39
Life stage (juvenile)*	1.11	0.30	0.52	1.70
Taxon (invertebrate)*	1.38	0.34	0.69	2.06
Host origin (non-native)	0.34	0.35	-0.34	1.01
Agent (parasite)	0.14	0.37	-0.59	0.88
Agent (virus)	0.15	0.35	-0.54	0.85
Mortality metric (maximum)	0.55	0.32	-0.089	1.18
<b>(b) Duration</b>				
Fixed effects	Coefficient	SEu	2.5%	97.5%
Reference	3.39	0.33	2.75	4.05
Latitude*	0.021	0.0062	0.0092	0.034
Governance efficiency	0.061	0.15	-0.25	0.36
Life stage (juvenile)	-0.060	0.17	-0.40	0.28
Taxon (invertebrate)*	-0.68	0.22	-1.12	-0.25
Host origin (non-native)	0.37	0.19	0.0054	-0.75
Agent (parasite)	-0.29	0.20	-0.69	0.11
Agent (virus)	0.025	0.20	-0.37	0.43
Study scale (local)	-0.10	0.16	-0.42	0.22

cumulative mortality was, respectively, 0.96 vs. 0.65 (back-transformed parameter estimates where additional fixed factors and covariates equalled the reference: Table 1a). Disease outbreaks also proceeded more rapidly in the tropics; maximum outbreak duration at the equator was 60 days, whereas outbreaks in temperate regions were reported over durations of up to 192 days (Fig. 1c). Invertebrates tended to suffer more rapid disease progression than adult fish, with equatorial outbreaks lasting on average 15 vs. 30 days (back-transformed parameter estimates where additional fixed factors and covariates equalled the reference: Table 1b).

## Discussion

The latitudinal trend in disease outbreak severity and duration may in part be explained by human factors such as the effectiveness of management practices, policy implementation and reporting infrastructure. There may be better fish disease monitoring and control measures available for countries at higher latitudes, and indeed, government efficiency correlated positively with latitude (Fig. 2). However, government efficiency did not show a significant relationship with outbreak characteristics (Table 1), even when latitude was removed as a model covariate (see Table S3, Supporting information). Moreover, these trends cannot be explained by different management practices and disease control capacity in different regions because we excluded studies where intervention ended an outbreak or reduced its severity.

Overall, our findings indicate that the increase in aquaculture disease impacts towards the tropics is likely to be driven (at least in part) by environmental factors. In natural systems, infectious disease-related mortality is also more likely to occur at lower latitudes where relatively warmer climate promotes higher pathogen proliferation and transmission rate (Robar, Burness and Murray 2010). Here, we demonstrate that this trend similarly applies to aquaculture populations. When combined with the crowded conditions of aquaculture facilities and warmer temperatures, this provides ideal conditions for outbreaks (Krkosek 2010; Mennerat *et al.* 2010; Salama & Murray 2011) that can lead to more severe mortality and rapid progression of diseases. Additionally in the last 50 years, lower latitudinal regions have also seen the greatest increase in nitrogen deposition (McKenzie & Townsend 2007). Higher nutrient loading is associated with increased risk of infectious diseases, for instance, nitrogenous compounds present in run-off can challenge host immune responses and promote pathogen replication rate (Martin *et al.* 2010). Thus, future research should seek to identify the environmental parameters and management system parameters at lower latitudes, which contribute to the pattern of higher mortality and rapid disease progression associated with epizootics.

#### IMPLICATIONS FOR MANAGEMENT

The role of disease in limiting the aquaculture-based production of fish and shellfish has not been considered in empirical calculations of regional vulnerability to climate change (Handisyde *et al.* 2009). An important implication of our findings is that the aquaculture industry will need to focus on building the capacity to minimize and recover from pathogen-induced loss, an issue of greatest priority in tropical regions. There are different management approaches to minimizing vulnerabilities in aquaculture, such as investing in environmental monitoring infrastructure and steering towards sustainable production (Bush *et al.* 2010). Even so, any management framework should also take into account economic losses from disease outbreak (Karim *et al.* 2012). While aquaculture is considered a viable means to promote food security and improve socio-economic status of developing countries (Godfray *et al.* 2010), lower latitudinal regions have also been identified as being most vulnerable to the effects of climate change (Dulvy *et al.* 2011). Environmental change is expected to reduce available agricultural land and crop yield at lower latitudinal regions (Schmidhuber & Tubiello 2007) in addition to the productivity of capture fisheries (Cheung *et al.* 2010). Combined with the region's heavy dependency on fish protein (Allison *et al.* 2009; Dulvy *et al.* 2011) and the fact that 90% of the world's aquaculture production comes from developing countries (FAO 2012), our data present a strong case for considering the potential impacts of disease outbreaks in strategies to build infrastructure for food security in developing nations as a global priority.

Our results also suggest further directions for management consideration. For instance, juvenile stages displayed higher levels of disease-induced mortality than adults (Table 1a). This may be because the immune system of juveniles is not as fully developed compared with mature individuals. Additionally, juvenile stages have fewer resources to draw from to mount an effective response to infection without compromising other functions necessary for survival; thus, strategies to minimize mortality at juvenile stages will be important. We also found a general trend of higher mortality and shorter outbreak duration in invertebrates compared to finfish (Table 1). As invertebrates account for 35% of the world's total aquaculture production by volume (FAO 2012), mostly from low latitudinal regions (particularly crustaceans) (FAO 2010), research contributing to building disease resilience in shrimp and shellfish culture will be of primary importance to protecting food and socio-economic security.

#### FUTURE OF DISEASE OUTBREAKS IN AQUACULTURE

Aquaculture in tropical regions has the potential for greater economic loss in comparison with temperate regions due to climate change-mediated disease mortality in the light of current forecasts of decreasing water

quality and supply and increasing frequency of extreme weather events (Handisyde *et al.* 2009). Moreover, environmental deterioration may be more severe in tropical nations and interact with climate change outcomes, which are predicted to increase the frequency and risk of disease (Harvell *et al.* 2002), as well as altering the distribution and severity of disease outbreaks (Rohr *et al.* 2011). It will be important to monitor such emerging trends to implement adaptive management strategies as climatic and nutrient deposition patterns may act synergistically to result in even greater frequency of disease-induced stock mortalities in aquaculture.

There are also important ecological ramifications associated with our findings that should be considered in future risk assessments. Aquaculture operations may be an increasing threat to wild stocks, a problem that may be global in scope and particularly so in tropical nations if disease is not considered in the implementation of open aquaculture facilities. Certain rearing methods, such as cage systems in marine or freshwater systems, can facilitate pathogen exchange between farmed and wild populations (Johansen *et al.* 2011), leading to pathogen spillover (Krkosek *et al.* 2006) or spillback (Kelly *et al.* 2009). As well as reducing the profitability and sustainability of farming (Salama & Murray 2011; Jansen *et al.* 2012), pathogen exchange can result in epizootics that threaten a range of wild species, a phenomenon that has been well documented from terrestrial systems (Gottdenker *et al.* 2005; Colla *et al.* 2006). Aquacultural settings also have the potential to select for the evolution of more virulent pathogens (Pulkkinen *et al.* 2010; Mennerat *et al.* 2012). The introduction of such pathogens into the surrounding environment via introduced aquaculture species can consequently have devastating impacts on wild fish populations and pose a significant threat to local biodiversity, especially to those species that may be facing a range of threats or occur at low population numbers (e.g. Gozlan *et al.* 2005). Coupled with our findings that more severe outbreaks occur at lower latitudinal regions – where biodiversity reaches a maximum (Gaston 2000) – makes the exchange and potential amplification of disease between farmed and nature populations a considerable concern not only for aquaculture sustainability but also its impact on local aquatic fauna and ecosystems. The risk of acquiring or introducing virulent pathogen to biologically diverse locations should be taken into consideration when selecting sites for aquaculture, thus making biosecurity a key consideration for aquaculture sustainability (Pruder 2004; Lightner 2005; Bush *et al.* 2010).

While aquaculture systems are typically considered 'artificial', the insights gained from studying natural host-parasite systems may have application to outbreaks in aquaculture and in particular where ranching strategies are used. While ecological approaches can be applied to facilitate the development of more effective disease control and management practices, studying disease outbreaks in aquaculture can also broaden our understanding

of disease ecology. For example, research in aquaculture has revealed knowledge gaps in certain aspects of disease ecology such as immunology of invertebrates and its interactions with environmental factors (Mydlarz, Jones & Harvell 2006). Aquacultural systems provide a setting from which disease can be observed and documented in greater detail than outbreaks in the wild. Understanding how outbreaks are initiated and unfold in such settings can further provide insights into the evolutionary ecology of infectious agents, and there is a need for disease ecologists to engage and collaborate with members of aquaculture community.

#### RECOMMENDATIONS

Aquaculture operations at lower latitudes suffer higher cumulative mortality and faster outbreak progression, which in turn may be exacerbated by climate change, leading to conditions that select for more virulent pathogens (Mennerat *et al.* 2010). This can result in the introduction of pathogens with greater virulence into wild fisheries, a pattern well documented in terrestrial systems (Gottdenker *et al.* 2005; Colla *et al.* 2006). Identifying the environmental mechanisms underlying the relationship between latitude and outbreak severity and epizootic duration will be a fundamental direction for future research (Fig. 3).

Our review of the literature also revealed that many critical details required for in-depth global scale analyses of disease outbreaks often go unreported. Thus, there is a need to standardize the reporting of aquaculture-based epizootics to include key details such as sample size, duration, holding facility conditions, likely contributing factors (apart from the pathogenic agent itself), stocking density, rearing method, water temperature and time of year in which the outbreak occurred (Fig. 3). The requirement of detailed reports on outbreaks serves to highlight the importance of engaging with the aquaculture industry to encourage monitoring and reporting.

Identifying host traits and relative susceptibility to different disease agents under different conditions will be important to generate adaptation strategies that reduce the exposure of farmed animals to extreme climate conditions that stress physiological and immune systems (e.g. by moving net cages to depth when warm weather events are forecasted) and the sensitivity of animals to such exposure (e.g. through selection of thermotolerant genotypes for cultivation). Moreover, preventative actions are required to minimize the potential for common outbreak drivers such as high stock density, injuries following transport, closed rearing methods and open exchange pathways that lead to infection and spread (Bush *et al.* 2010; Salama & Murray 2011). By limiting the potential for disease outbreaks in combination with efforts to promote adaptive capacity, such as building the required expertise and infrastructure to farm species that are less susceptible to infection under climate change, will reduce

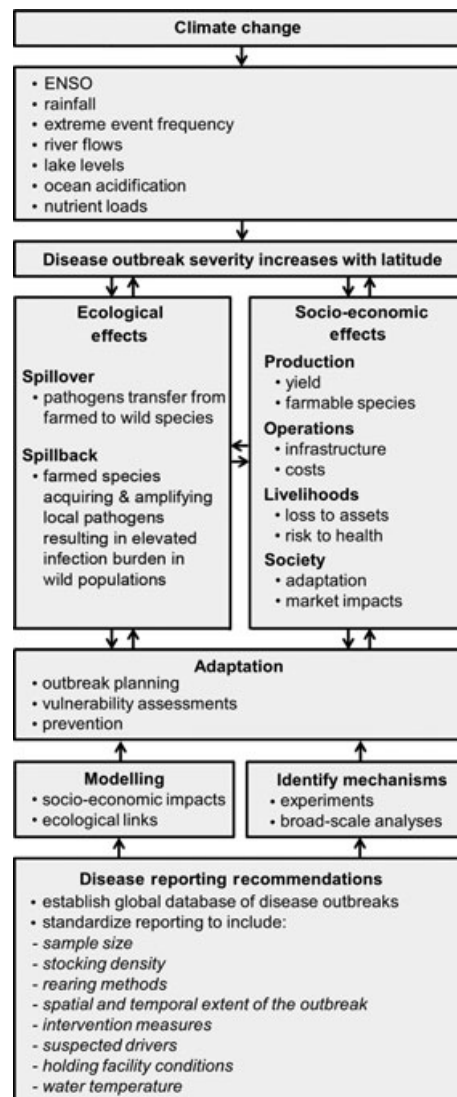

**Fig. 3.** Summary of linkages between the biophysical and socio-economic systems with disease outbreaks in aquaculture. Arrows indicate the direction of influence between those climate change-related physical factors expected to alter disease outbreak patterns in aquaculture and the ecological and socio-economic effects of outbreaks. We offer recommendations for reporting to inform both mechanistic understanding of disease outbreak patterns and forecasting capacity that will ultimately enhance adaptation efforts.

the vulnerability of the industry to disease-related economic loss and adaptation efforts (Fig. 3).

Our study indicates that, for aquaculture to become a viable and sustainable option for ensuring food security, particularly in developing countries, any such venture must be integrated with the development of reliable disease management plans and biosecurity infrastructure to promote outbreak prevention and resilience in production systems.

#### Acknowledgements

We thank three anonymous reviewers who provided highly constructive comments that improved the manuscript. Sarah Herbert, Robert Poulin

and David Thielges also commented on manuscript drafts. Mike Melnychuk provided advice on modelling approaches.

T.L.F.L. and A.E.B. conceived the study, designed the experiment and collected the data. A.E.B. conducted the statistical analyses. T.L.F.L. and A.E.B. discussed the results and wrote the manuscript.

The authors declare no competing financial interests.

## References

- Allison, E.H., Perry, A.L., Badjeck, M.C., Neil Adger, W., Brown, K., Conway, D., Halls, A.S., Pilling, G.M., Reynolds, J.D., Andrew, N.L. & Dulvy, N.K. (2009) Vulnerability of national economies to the impacts of climate change on fisheries. *Fish and Fisheries*, **10**, 173–196.
- Altizer, S., Dobson, A., Hosseini, P., Hudson, P., Pascual, M. & Rohani, P. (2006) Seasonality and the dynamics of infectious diseases. *Ecology Letters*, **9**, 467–484.
- Bartoň, K. (2009) *MuMIn: Multi-Model Inference*. R package version 0.12.2. <http://R-Forge.R-project.org/projects/mumin/>
- Benejam, L., Alcaraz, C., Sasal, P., Simon-Levert, G. & Garcia-Berthou, E. (2009) Life history and parasites of the invasive mosquitofish (*Gambusia holbrooki*) along a latitudinal gradient. *Biological Invasions*, **11**, 2265–2277.
- Burnham, K.P. & Anderson, D.R. (2002) *Model Selection and Multimodel Inference: A Practical Information-Theoretic Approach*, 2nd edn. Springer, Berlin.
- Bush, S.R., Zwieten, P.A.M.V., Visser, L., Dijk, H.V., Bosma, R., Boer, W.F.D. & Verdegem, M. (2010) Scenarios for resilient shrimp aquaculture in tropical coastal areas. *Ecology and Society*, **15**, art 15.
- Calvete, C. (2003) Correlates of helminth community in the red-legged partridge (*Alectoris rufa* L.) in Spain. *Journal of Parasitology*, **89**, 445–451.
- Cheung, W.W.L., Lam, V.W.Y., Sarmiento, J.L., Kearney, K., Watson, R.E.G., Zeller, D. & Pauly, D. (2010) Large-scale redistribution of maximum fisheries catch potential in the global ocean under climate change. *Global Change Biology*, **16**, 24–35.
- Colla, S.R., Otterstatter, M.C., Gegeer, R.J. & Thomson, J.D. (2006) Plight of the bumble bee: pathogen spillover from commercial to wild populations. *Biological Conservation*, **129**, 461–467.
- Dulvy, N.K., Reynolds, J.D., Pilling, G.M., Pinnegar, J.K., Phillips, J.S., Allison, E.H. & Badjeck, M.C. (2011) Fisheries management and governance challenges in a climate change. *The Economics of Adapting Fisheries to Climate Change* (ed OECD). OECD Publishing, doi: 10.1787/9789264090415-en.
- FAO (2010) *FAO Yearbook*. Fishery and Aquaculture Statistics 2008, Rome, Italy.
- FAO (2012) *The State of World Fisheries and Aquaculture 2012*. Rome, Italy.
- Fox, J. & Weisberg, S. (2011) *An R Companion to Applied Regression*, 2nd edn. Thousand Oaks, California, Sage.
- Gaston, K.J. (2000) Global patterns in biodiversity. *Nature*, **405**, 220–227.
- Godfray, H.C.J., Beddington, J.R., Crute, I.R., Haddad, L., Lawrence, D., Muir, J.F., Pretty, J., Robinson, S., Thomas, S.M. & Toulmin, C. (2010) Food Security: The Challenge of Feeding 9 Billion People. *Science*, **327**, 812–818.
- Gottdenker, N.L., Walsh, T., Vargas, H., Merkel, J., Jiménez, G.U., Miller, R.E., Dailey, M. & Parker, P.G. (2005) Assessing the risks of introduced chickens and their pathogens to native birds in the Galápagos Archipelago. *Biological Conservation*, **126**, 429–439.
- Gozlan, R.E., St-Hilaire, S., Feist, S.W., Martin, P. & Kent, M.L. (2005) Biodiversity: disease threat to European fish. *Nature*, **435**, 1046.
- Guernier, V., Hochberg, M.E. & Guegan, J.F.O. (2004) Ecology drives the worldwide distribution of human diseases. *Plos Biology*, **2**, 740–746.
- Handisyde, N., Ross, L., Badjeck, M.C. & Allison, E.H. (2009) *The Effects of Climate Change on World Aquaculture: A Global Perspective*. Department for International Development, UK.
- Harvell, C.D., Mitchell, C.E., Ward, J.R., Altizer, S., Dobson, A.P., Ostfeld, R.S. & Samuel, M.D. (2002) Ecology – climate warming and disease risks for terrestrial and marine biota. *Science*, **296**, 2158–2162.
- IPCC (2007) Climate Change 2007: Contribution of Working Group II to the Fourth Assessment Report of the Intergovernmental Panel on Climate Change, 2007. *Climate Change 2007: Impacts, Adaptation and Vulnerability* (eds M.L. Parry, O.F. Canziani, J.P. Palutikof, P.J. van der Linden & C.E. Hanson), pp. 976. Cambridge University Press, Cambridge, UK.
- Jansen, P.A., Kristoffersen, A.B., Viljugrein, H., Jimenez, D., Aldrin, M. & Stien, A. (2012) Sea lice as a density-dependent constraint to salmonid farming. *Proceedings of the Royal Society B: Biological Sciences*, **279**, 2330–2338.
- Johansen, L.H., Jensen, I., Mikkelsen, H., Bjørn, P.A., Jansen, P.A. & Bergh, Ø. (2011) Disease interaction and pathogens exchange between wild and farmed fish populations with special reference to Norway. *Aquaculture*, **315**, 167–186.
- Karim, M., Sarwer, R.H., Brooks, A.C., Gregory, R., Jahan, M.E. & Belton, B. (2012) The incidence of suspected white spot syndrome virus in semi-intensive and extensive shrimp farms in Bangladesh: implications for management. *Aquaculture Research*, **43**, 1357–1371.
- Karvonen, A., Rintamaki, P., Jokela, J. & Valtonen, E.T. (2010) Increasing water temperature and disease risks in aquatic systems: climate change increases the risk of some, but not all, diseases. *International Journal for Parasitology*, **40**, 1483–1488.
- Kelly, D.W., Paterson, R.A., Townsend, C.R., Poulin, R. & Tompkins, D. M. (2009) Parasite spillback: a neglected concept in invasion ecology? *Ecology*, **90**, 2047–2056.
- Krkosek, M. (2010) Host density thresholds and disease control for fisheries and aquaculture. *Aquaculture Environment Interactions*, **1**, 21–32.
- Krkosek, M., Lewis, M.A., Morton, A., Frazer, L.N. & Volpe, J.P. (2006) Epizootics of wild fish induced by farm fish. *Proceedings of the National Academy of Sciences of the United States of America*, **103**, 15506–15510.
- Lightner, D.V. (2005) Biosecurity in shrimp farming: pathogen exclusion through use of SPF stock and routine surveillance. *Journal of the World Aquaculture Society*, **36**, 229–248.
- Martin, L.B., Hopkins, W.A., Mydlarz, L.D. & Rohr, J.R. (2010) The effects of anthropogenic global changes on immune functions and disease resistance. *Annals of the New York Academy of Sciences*, **1195**, 129–148.
- McCallum, H., Harvell, D. & Dobson, A. (2003) Rates of spread of marine pathogens. *Ecology Letters*, **6**, 1062–1067.
- McKenzie, V.J. & Townsend, A.R. (2007) Parasitic and infectious disease responses to changing global nutrient cycles. *EcoHealth*, **4**, 384–396.
- Mennerat, A., Nilsen, F., Ebert, D. & Skorpjng, A. (2010) Intensive farming: evolutionary implications for parasites and pathogens. *Evolutionary Biology*, **37**, 59–67.
- Mennerat, A., Hamre, L., Ebert, D., Nilsen, F., Dávidová, M. & Skorpjng, A. (2012) Life history and virulence are linked in the ectoparasitic salmon louse *Lepeophtheirus salmonis*. *Journal of Evolutionary Biology*, **25**, 856–861.
- Merino, S., Moreno, J., Vasquez, R.A., Martinez, J., Sanchez-Monsalvez, I., Estades, C.F., Ippi, S., Sabat, P., Rozzi, R. & Megehee, S. (2008) Haematocytosis in forest birds from southern Chile: latitudinal gradients in prevalence and parasite lineage richness. *Austral Ecology*, **33**, 329–340.
- Mydlarz, L.D., Jones, L.E. & Harvell, C.D. (2006) Innate immunity environmental drivers and disease ecology of marine and freshwater invertebrates. *Annual Review of Ecology Evolution and Systematics*, **37**, 251–288.
- Nunn, C.L., Altizer, S.M., Sechrest, W. & Cunningham, A.A. (2005) Latitudinal gradients of parasite species richness in primates. *Diversity and Distributions*, **11**, 249–256.
- Pillay, T.V.R. & Kutty, M.N. (2005) *Aquaculture: Principles and Practices*, 2nd edn. Wiley-Blackwell, Oxford, UK.
- Pruder, G.D. (2004) Biosecurity: application in aquaculture. *Aquacultural Engineering*, **32**, 3–10.
- Pulkkinen, K., Suomalainen, L.R., Read, A.F., Ebert, D., Rintamaki, P. & Valtonen, E.T. (2010) Intensive fish farming and the evolution of pathogen virulence: the case of columnaris disease in Finland. *Proceedings of the Royal Society B: Biological Sciences*, **277**, 593–600.
- R Development Core Team (2011) *A Language and Environment for Statistical Computing*. R Foundation for Statistical Computing, Vienna, Austria.
- Robar, N., Burness, G. & Murray, D.L. (2010) Tropics, trophics and taxonomy: the determinants of parasite-associated host mortality. *Oikos*, **119**, 1273–1280.
- Rohde, K. & Heap, M. (1998) Latitudinal differences in species and community richness and in community structure of metazoan endo- and ectoparasites of marine teleost fish. *International Journal for Parasitology*, **28**, 461–474.
- Rohr, J.R., Dobson, A.P., Johnson, P.T.J., Kilpatrick, A.M., Paull, S.H., Raffel, T.R., Ruiz-Moreno, D. & Thomas, M.B. (2011) Frontiers in climate change-disease research. *Trends in Ecology & Evolution*, **26**, 270–277.

**222** *T. L. F. Leung & A. E. Bates*

- Salama, N.K.G. & Murray, A.G. (2011) Farm size as a factor in hydrodynamic transmission of pathogens in aquaculture fish production. *Aquaculture Environment Interactions*, **2**, 61–74.
- Schmidhuber, J. & Tubiello, F.N. (2007) Global food security under climate change. *Proceedings of the National Academy of Sciences of the United States of America*, **104**, 19703–19708.
- Smith, K.F., Dobson, A.P., McKenzie, F.E., Real, L.A., Smith, D.L. & Wilson, M.L. (2005) Ecological theory to enhance infectious disease control and public health policy. *Frontiers in Ecology and the Environment*, **3**, 29–37.
- The World Bank Group (2011) <http://info.worldbank.org/governance/wgi/resources.htm>, accessed May 25, 2012.
- UNPD (2006) *World Population Projections, the 2006 Revision*. NY, New York.
- Whittington, R.J., Jones, J.B., Hine, P.M. & Hyatt, A.D. (1997) Epizootic mortality in the pilchard *Sardinops sagax neopilchardus* in Australia and New Zealand in 1995.1. Pathology and epizootiology. *Diseases of Aquatic Organisms*, **28**, 1–16.
- Zuur, A.F., Ieno, E.N. & Elphick, C.S. (2009) A protocol for data exploration to avoid common statistical problems. *Methods in Ecology and Evolution*, **1**, 3–14.

*Received 25 July 2012; accepted 29 October 2012*  
*Handling Editor: Nick Dulvy*

**Supporting Information**

Additional Supporting Information may be found in the online version of this article.

Table S1. Data table and references.

Table S2. Confidence model sets.

Table S3. Summary of model results with latitude removed as a covariate.

## AMERICAS

# Norwegians Concede a Role in Chilean Salmon Virus

By ALEXEI BARRIONUEVO JULY 27, 2011

SÃO PAULO, Brazil — A virus that has killed millions of salmon in Chile and ravaged the fish farming industry there was probably brought over from Norway, a major salmon producer has acknowledged.

Cermaq, a state-controlled Norwegian aquaculture company that has become one of the principal exporters of salmon from Chile, has endorsed a scientific study concluding that salmon eggs shipped from Norway to Chile are the “likely reason” for the outbreak of the virus in 2007, according to Lise Bergan, a company spokeswoman.

But, she argued, “the report didn’t pinpoint any company” as the culprit.

The virus, infectious salmon anaemia, or I.S.A., was first reported at a Chilean salmon farm owned by Marine Harvest, another Norwegian company. It quickly spread through southern Chile, wracking a fishing business that had become one of the country’s biggest exporters during the past 15 years. The Chilean industry, whose major clients include the United States and Brazil, suffered more than \$2 billion in losses, saw its production of Atlantic salmon fall by half and had to lay off 26,000 workers.

The outbreak in Chile also revealed structural problems within the industry,

Access more of The Times by creating a free account or logging in.

CONTINUE

[Subscriber Login](#)

instituted a wide range of reforms to try to contain outbreaks, but despite extensive efforts to rein it in the virus continues to spread.

Last week, Chilean authorities said 23 production centers were suspected of having the virus, but of the nonvirulent type. There have been no reported outbreaks of virulent I.S.A. this year, officials said.

As the disease has spread, the industry has continued to push farther south, shifting cultivation away from the virus-afflicted areas. While the virus is not harmful to humans, some buyers, like the supermarket giant Safeway, restricted imports from Chile because of it.

Since 1984, when it was first diagnosed in Norway, the I.S.A. virus had an outbreak in every major salmon-farming region in the world except British Columbia, said Don Staniford, the global coordinator for the Global Alliance Against Industrial Aquaculture, a nongovernmental organization.

“Once it is discovered, it is impossible to get rid of,” he said.

The scientific study at the University of Bergen linking the virus to eggs was commissioned by Cermaq and first published in 2008 in the *Archives of Virology*. But in early 2009, shortly after publication, a Norwegian company that breeds fish eggs, Aqua Gen — which is partly owned by both Cermaq and Marine Harvest — filed a formal complaint about the study with Norway’s National Commission for the Investigation of Scientific Misconduct, arguing that the science was flawed.

Patrick Dempster, general manager of Aqua Gen in Chile, said that Aqua Gen complained about the study because in 2006 they became the principal exporter of salmon eggs to Chile and were worried about losing business over concern about any vertical transmission connection with Norway.

The commission ruled on April 6 that there had been no scientific misconduct, clearing the three authors from the University of Bergen. Mr. Dempster said Aqua Gen stood by a study from the University of Prince Edward Island that concluded

Access more of The Times by creating a free account or logging in.

CONTINUE

[Subscriber Login](#)

fish eggs to Chile. He noted that between 1996 and 2007 “a multitude” of Chilean and Norwegian companies sent eggs from Norway to Chile.

“We initiated that research because we wanted to understand how I.S.A. was transmitted,” Ms. Bergan said. “Before that, the scientific consensus” was that the virus “could not be transmitted by eggs.”

But while Cermaq has accepted the study’s findings, Chile’s own National Fishing Service, Sernapesca, said it did not necessarily support them. Instead, Sernapesca referred to the conclusion of the World Organization for Animal Health, which has said that there is insufficient evidence that the I.S.A. virus can be transmitted through eggs.

“Since the start of the I.S.A. outbreak, Sernapesca incorporated regulations both for the importing of eggs and for the production of eggs” in Chile, the agency said in response to e-mailed questions.

The University of Prince Edward Island study, by Frederick Kibeng, an I.S.A. expert, was commissioned by Marine Harvest. It showed that some I.S.A. virus strains in Chile diverged from Norwegian strains around 1996. The study “does not confirm” vertical transmission, but “it cannot be ruled out as a possible route of transmission,” said Jorgen Christiansen, a spokesman for Marine Harvest.

Cermaq, which described itself as the leading exporter of salmon from Chile in the first quarter of this year, has also developed methods for screening the I.S.A. virus, invested in new facilities and moved its production of young Atlantic salmon to facilities on land, Ms. Bergan said.

Norway and Chile have become intertwined by their farmed-fish industries. Norway has the largest aquaculture industry in the world, but Chile is often viewed as the salmon market of the future, with room for rapid expansion. The governments have a cooperation treaty to exchange scientific and technical knowledge in aquaculture.

Access more of The Times by creating a free account or logging in.

CONTINUE

[Subscriber Login](#)



# JOURNAL OF FISH DISEASES

ORIGINAL ARTICLE

## Overview of infectious salmon anaemia virus (ISAV) in Atlantic Canada and first report of an ISAV North American-HPR0 subtype

N Gagné , F LeBlanc

First published: 07 August 2017 |  
<https://doi.org/10.1111/jfd.12670> | Citations: 4

### Abstract

The infectious salmon anaemia virus (ISAV) is an important viral disease of farmed Atlantic salmon that has caused considerable financial losses for salmon farmers around the world, including Atlantic Canada. It is listed as a notifiable disease by the World Organization for Animal Health, and to this day, culling of infected cages or farms remains the current practice in many countries to mitigate the spread of the virus. In Atlantic Canada, ISAV was first detected in 1996 and continues to be detected. While some outbreaks seemed to have arisen from isolated infections of unknown source, others were local clusters resulting from horizontal spread of infection. This study provides a description of the detected ISAV isolates in Atlantic Canada between 2012 and 2016, and explores the phylogenetic relatedness between these ISAV isolates. A key finding is the detection for the first time of a North American-HPR0

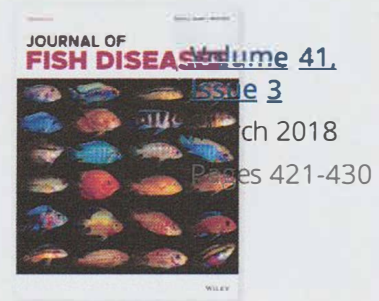

Related

Info

### Metrics

Citations: 4



### Details

© 2017 John Wiley &amp; Sons Ltd

### Keywords

Atlantic Canada Atlantic sal  
 ISAV ISAV NA-HPR0 phyl

### Funding Information

National Aquatic Animal Heal  
 (NAAHP)

Canadian Food Inspection Ag  
 Fisheries and Oceans Canada

ISAV subtype, which was predicted to exist for many years. Through phylogenetic analysis, a scenario emerges with at least three separate incursions of ISAV in Atlantic Canada. An initial ISAV introduction follows a genotypic separation between North America and Europe which resulted in the NA and EU genotypes known today; this separation predates the salmon aquaculture industry. The second incursion of ISAV from Europe to North America led to a sublineage in Atlantic Canada consisting of EU-HPRΔ isolates detected in Nova Scotia and New Brunswick, and the predominant form of ISAV-HPR0 (EU). Finally, we observed what could be the third and most recent incursion of ISAV in Newfoundland, in the form of an isolate highly similar to ISAV EU-HPR0 isolates found in the Faroe Islands and the one isolate from Norway.

#### Citing Literature



#### Supporting Information



Filename	Description
----------	-------------

[jfd12670-sup-0001-TableS1.xlsx](#) MS Excel, 19.3 KB

Please note: The publisher is not responsible for the content or functionality of any supporting information supplied by the authors. Any queries (other than missing content) should be directed to the corresponding author for the article.

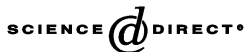

ELSEVIER

Available online at [www.sciencedirect.com](http://www.sciencedirect.com)

Aquacultural Engineering 28 (2003) 21–36

[www.elsevier.com/locate/aqua-online](http://www.elsevier.com/locate/aqua-online)aquacultural  
engineering

# Ozonation and UV irradiation—an introduction and examples of current applications

Steven T. Summerfelt\*

*Director of Aquaculture Systems Research, The Conservation Fund's Freshwater Institute, P.O. Box 1889, Shepherdstown, WV 25443, USA*

Received 24 July 2002; accepted 8 November 2002

---

## Abstract

This paper was written to introduce the 2001 AES Issues Forum's 'Ozone and UV Treatment' session by providing an overview of ozone and ultraviolet (UV) irradiation technologies as well as several examples of current ozone and UV irradiation applications in aquaculture.

© 2002 Elsevier Science B.V. Open access under [CC BY-NC-ND license](https://creativecommons.org/licenses/by-nc-nd/4.0/).

*Keywords:* Ultraviolet irradiation; Ozonation; Aquaculture; Oxidation; Disinfection

---

## 1. Introduction

Ozone is a powerful oxidizing agent that has seen wide use in aquaculture applications for achieving both disinfection and water quality improvements (Rosenthal, 1981; Owsley, 1991; Cryer, 1992; Wedemeyer, 1996; Summerfelt and Hochheimer, 1997). Ozone is added to aquaculture system waters to inactive fish pathogens, oxidize organic wastes (including color) and nitrite, or supplement the effectiveness of other water treatment units. Ozone has some advantages because it has a rapid reaction rate, produces few harmful reaction by-products in freshwater, and oxygen is produced as a reaction end-product.

Ultraviolet (UV) irradiation is also being widely applied within aquaculture systems. However, the primary objective of UV irradiation is disinfection. In

---

\* Tel.: +1-304-876-2815; fax: +1-304-870-2211.

E-mail address: [s.summerfelt@freshwaterinstitute.org](mailto:s.summerfelt@freshwaterinstitute.org) (S.T. Summerfelt).

contrast to ozonation, UV irradiation is not generally considered to be a process that is applied to supplement the effectiveness of other water treatment units.

## **2. Ozonation**

Ozone application within aquaculture systems requires ozone generation, ozone transfer into solution, contact time for ozone to react, and possibly ozone destruction to ensure that no ozone residual makes it into the culture tanks (Summerfelt and Hochheimer, 1997). These requirements are discussed, along with certain key issue regarding the application of ozone within recirculating aquaculture systems.

### *2.1. Ozone generation*

Ozone is typically generated within an enriched oxygen feed gas using an electrical corona discharge. Enriched oxygen feed gases are often used because ozone production is 2–3 times more energy efficient when an oxygen feed gas is used instead of air (Masschelein, 1998), and because purified oxygen feed gas supplies are already used to maximize carrying capacity within many intensive aquaculture systems. Corona discharge generation using purified oxygen feed gas requires about 10 kWh of electricity to produce 1.0 kg of ozone (Masschelein, 1998). Also, generating ozone in oxygen feed gas can produce a 10–15% (by weight) concentration of ozone, which nearly doubles the concentration of ozone that can be generated using air as the feed gas. The relatively high concentrations of ozone can be generated to reduce the overall mass of oxygen required to supply ozone. Yet, it is less energetically efficient to produce ozone concentrations of 10–15% (by weight) than to produce ozone concentrations of 4–6% (Carlins and Clark, 1982). Taking all of this into account, ozone production can be optimized according to the demands of the aquaculture system and economic considerations of feed gas cost and energy usage.

### *2.2. Ozone transfer*

Ozone generated within either an air or oxygen feed gas must be transferred into water for microbiological inactivation or other oxidative purpose. The ozone gas can be transferred into the water using any of the typical oxygen transfer devices (Summerfelt and Hochheimer, 1997). Effective transfer of ozone into water is important because the cost of producing ozone is not insignificant, especially if the ozone is carried within a purified oxygen feed gas that is either purchased or produced on site.

The rate of ozone transfer and the subsequent rate of ozone decomposition depends upon the contact system efficiency and the reaction rates of ozone with constituents in the water. The ozone reaction rate depends on the water temperature and on the concentration and type of constituents contained in the water. Rapid

reaction with oxidizable inorganic and organic material will maintain a low apparent equilibrium concentration of ozone within the liquid film and increase the rate of ozone transfer compared to water's without oxidizable inorganic and organic material. The driving force for ozone transfer is maximized when the ozone absorbed is rapidly consumed by reaction with constituents within water. In fact, when ozone reacts very fast, ozone decomposes at the gas surface and no molecular ozone is transferred into the water (Bablon et al., 1991).

Ozone transfer units that have a continuous liquid-phase (i.e., units that disperse gas bubbles within a liquid)—such as Speece cones (Fig. 1), U-tubes (Fig. 2), aspirators, bubble diffusers, and enclosed mechanical surface or subsurface mixers—provide both ozone transfer and some reaction time. Ozone transfer units that have a continuous gas-phase (i.e., units that disperse liquid drops and films within a gas)—

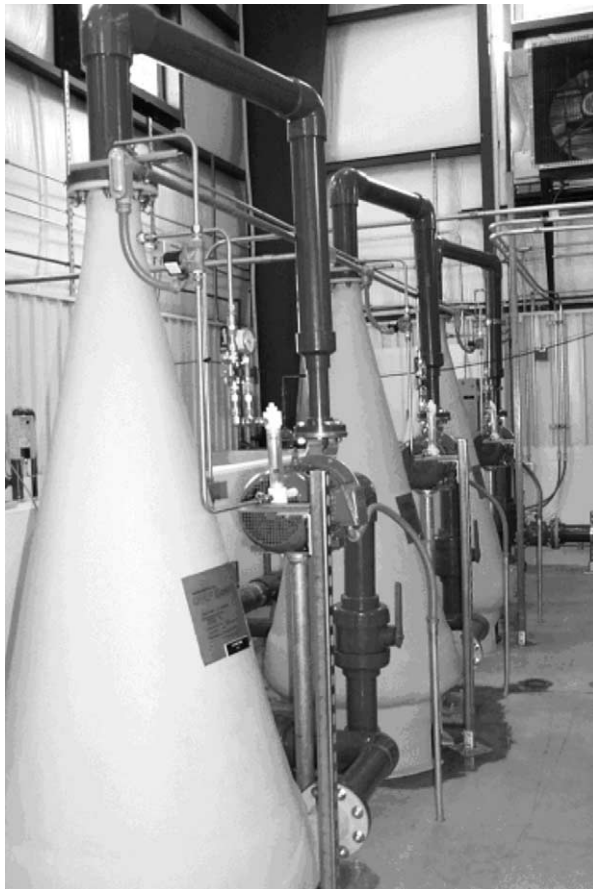

Fig. 1. An ozone/oxygen feed gas is injected into water within three Speece cones (plumbed in parallel for redundancy and variable flow requirements). The system shown is used to disinfect 400–2400 l/min of surface water at the US Fish and Wildlife Service's Northeast Fishery Center in Lamar, PA (Summerfelt et al., in press).

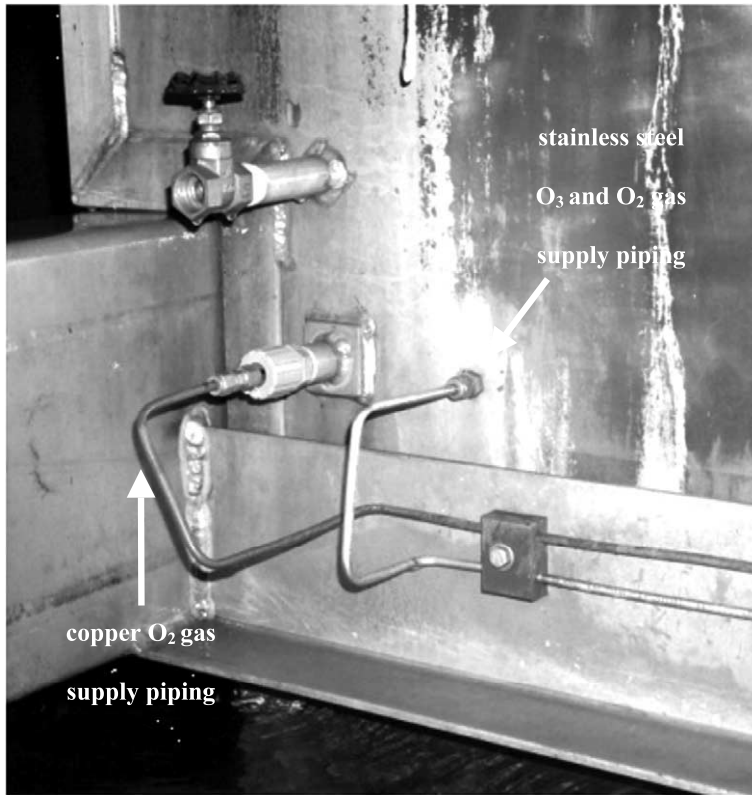

Fig. 2. A copper pipe is used to supply the pure oxygen feed gas to a LHO unit, while a stainless steel pipe is used to carry the ozonated feed gas. The LHO is used to oxygenate/ozonate 4800 l/min of water in a recirculating system at the Conservation Fund Freshwater Institute (Shepherdstown, WV).

such as spray columns, packed columns, and multi-stage low head oxygenators (Fig. 3)—provide efficient transfer but very little time for reaction (Summerfelt and Hochheimer, 1997). Continuous gas-phase transfer units are best suited for use in situations where the maximum amount of ozone needs to be transferred in the shortest time. Continuous liquid-phase transfer units are usually selected for situations where reaction is rate limiting and an ozone residual must be maintained for a specific length of time (Bellamy et al., 1991).

Most ozone contactors rely on continuous liquid-phase units that bubble ozone into the liquid (Bellamy et al., 1991). High column bubble diffusers are frequently used for aquacultural applications and can achieve more than 85% ozone transfer to the liquid phase (Liltved, 2001). These units are particularly well suited to situations where reaction is rate limiting and an ozone residual must be maintained for a specific length of time, such as during disinfection. Speece cones (Fig. 1), U-tubes, and low head oxygenators (Fig. 2) are also being used to efficiently and rapidly

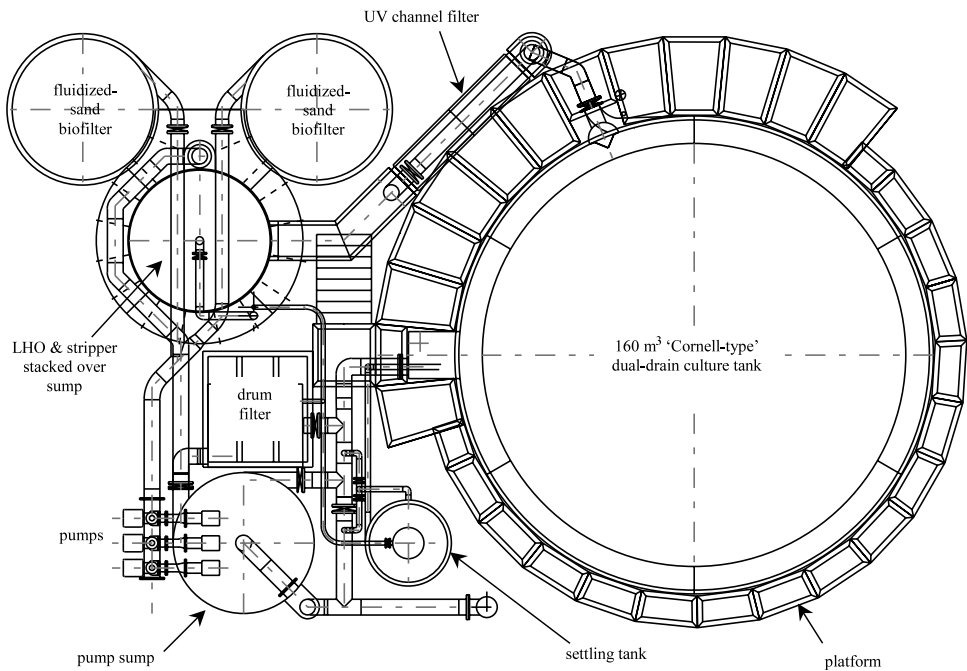

Fig. 3. The 4800 l/min recirculating system at the Freshwater Institute was designed for ozone addition within the purified oxygen feed gas supplied to the LHO unit. Drawing courtesy of Marine Biotech, Inc. (Beverly, MA).

transfer ozone/oxygen feed gas within recirculating aquaculture systems (Summerfelt et al., 2000), where the primary goals of the gas transfer units are to:

- supply supersaturated levels of dissolved oxygen that will increase the culture tank carrying capacity, and
- transfer ozone (carried within the purified oxygen feed gas) to oxidize nitrite and organic matter and supplement the effectiveness of other treatment processes.

Ozone transfer within continuous gas-phase units is not as common as within continuous liquid-phase units (Bellamy et al., 1991). When ozone transfer has been reported within continuous gas-phase units, the applications are mostly within packed columns and more recently within low head oxygenators that are used in recirculating system applications (Fig. 3). However, the relatively high transfer efficiency and relatively small vessel requirement of continuous gas-phase transfer units do make these units attractive when compared to the transfer efficiency and foot print of high column bubble diffuser systems.

If ozone transfer is not 100% efficient, then the off-gas discharged from the transfer unit will contain some ozone. Because ozone is toxic, the ozone in these off-gas flows must be treated to destroy the remaining ozone before the gas is discharged.

### 2.3. Ozone disinfection and maintaining an ozone residual

Ozone oxidation can kill microorganisms, but disinfecting the water requires maintaining a certain dissolved ozone concentration for a given contact time. Thus, disinfecting efficiency depends on the product of the ozone residual concentration multiplied by its contact time. An ozone contact vessel should provide the time necessary for the ozone residual to react with and inactivate the target microorganism(s). Disinfecting water can require maintaining a residual ozone concentration of 0.1–2.0 mg/l in a plug-flow type contact vessel for periods of 1–30 min, depending upon the target microorganism. Wedemeyer (1996) and Liltved (2001), and Summerfelt et al. (in press) provide reviews on ozone dosing requirements for various fish pathogens. These reviews indicate that many pathogenic organism can be inactivated by ozone  $c \times t$  dosages of 0.5–5.0 min mg/l. Unfortunately, certain spore forming organism are especially hard to inactivate with ozone.

Ozone has seen frequent use for pre-treating surface waters supplied to fish farms (Liltved, 2001) and state or federal fish hatcheries (Roselund, 1975; Owsley, 1991; Cryer, 1992; Summerfelt et al., in press) in situations where water born pathogens are a significant concern or problem. On occasion, ozone has also been used to disinfect fish hatcheries discharges in an attempt to prevent the potential for the release of fish pathogens to the receiving watershed (Liltved, 2001).

In order to achieve the desired disinfecting  $c \times t$  (i.e., the product of the ozone residual concentration at the end of the contact vessel multiplied by the hydraulic retention time of the contact tank), an ozone dose sufficiently high to account for the initial ozone demand of the water must be provided. In natural waters and in waters found within recirculating systems, additional ozone will be lost in reactions with organics and other compounds at rates that depend upon the water temperature. According to ozone demand tests on a high quality trout stream water being ozone disinfected at the US Fish and Wildlife Service Northeast Fishery Center (Lamar, PA), an ozone concentration of 2–4 mg/l must be transferred to maintain a 0.2 mg/l ozone residual concentration after 10 min (Summerfelt et al., in press). Cryer (1992) reported similar ozone demand results in tests on surface water supplies that were being disinfected at US Fish and Wildlife Service salmonid hatcheries in North America. All of the surface water supplies examined in these studies exhibit relatively high water quality with low concentrations of oxidizable organic material, iron, and manganese (Cryer, 1992; Summerfelt et al., in press), yet the ambient ozone demand reduces the half-life of ozone to less than a few minutes. In comparison, the half-life of ozone dissolved in pure water at 20 °C is 165 min (Rice et al., 1981). The ozone demand of water within recirculating aquaculture systems, which contains much higher levels of organic material and nitrite, creates an even shorter ozone half-life (e.g., < 15 s), which makes maintaining an ozone residual difficult (Bullock et al., 1997). For this reason, achieving large microorganism reductions in recirculating systems requires much greater ozone dosages than are required for simply controlling water quality within these systems (Bullock et al., 1997) and also much higher ozone dosages than are typically required for disinfecting single-pass inflows.



When sufficient ozone has been transferred to create a disinfecting ozone residual concentration at the end of the contact chamber, then that residual will need to be removed before the water reaches aquatic organisms in the culture tanks. Residual ozone can be lethal to fish at concentrations as low as 0.01 mg/l, but the actual concentration depends upon species and life stage (Section 2.4). To abate this potential problem, dissolved ozone can be removed by providing extended contact times, aeration and degassing, intense UV light doses, or reaction with hydrogen peroxide (Section 2.5).

The surface water filtration and ozonation system at the US Fish and Wildlife Service's Northeast Fishery Center (Lamar) is an example of the ozone contacting and removal sequence that can be employed to provide contact time for disinfection and also protect the fish culture system from ozone residual (Summerfelt et al., in press). This system (Fig. 4) first uses a pair of 60- $\mu$ m microscreen drum filters to remove fine particulates that might shield pathogens from dissolved ozone. The system then uses Speece cones (Fig. 1) to transfer ozone into the water and subsequently provides contact time for the ozone within a two-reactor sequence that is followed by a ventilated cascade column (Fig. 4). The first vessel in the sequence provides the ozone contact time (e.g., 10 min HRT) required to achieve disinfection and the second larger vessel requires the contact time (e.g., 20 min HRT) for dissipation of much of the ozone residual. A dissolved ozone probe is used to monitor the ozone concentration exiting the first contact vessel and this information is used in a PID control loop to adjust the ozone generator output for maintaining a constant 0.2 mg/l of ozone residual concentration following the first ozone contact

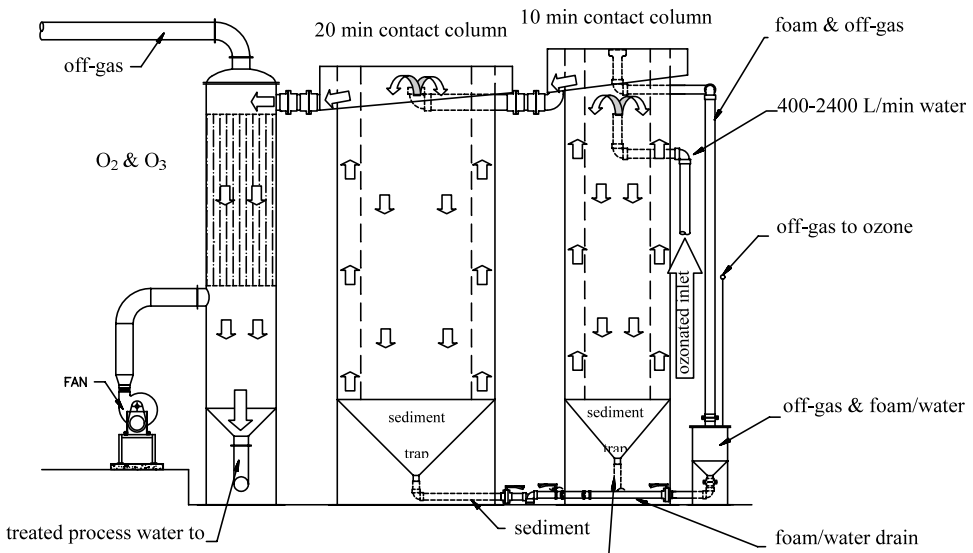

Fig. 4. Ozone Treatment system for disinfecting 400–2400 l/min of surface water at the US Fish and Wildlife Service's Northeast Fishery Center in Lamar, PA (Summerfelt et al., in press). Drawing courtesy of Oak Point Associates, Biddeford, ME.

tank. The ventilated cascade column (Fig. 4) is used to strip the remaining ozone residual while reducing excessive levels of dissolved oxygen before the water flow is supplied to the fish culture tanks.

#### 2.4. Ozone toxicity

Although ozone has a rapid reaction rate and few harmful reaction products, it is toxic to aquatic life at low levels (Wedemeyer et al., 1979; Langlais et al., 1991). Ozone gas is also toxic to humans. Standards set by the federal Occupational Safety and Health Administration only allows for a maximum single exposure level of 0.3 ppm for less than a 10 min duration and of 0.1 ppm on a time-weighted average for an 8-h period (Occupational Health and Safety Administration, 1993). Therefore, care must be used when transferring an ozone containing air or purified oxygen gas mixture into water, when providing time for reaction of dissolved ozone with the targeted constituents in the water, and when considering the removal or monitoring of dissolved ozone before the water enters the culture tanks (Summerfelt and Hochheimer, 1997).

##### 2.4.1. Freshwater applications

The maximum safe level of chronic ozone exposure for salmonids is 0.002 mg/l (Wedemeyer et al., 1979). A compilation of results from several studies indicates that most fish exposed to ozone concentrations greater than 0.008–0.06 mg/l will develop severe gill damage that can result in serum osmolality imbalances and can kill fish immediately or leave them more susceptible to microbial infections (Bullock et al., 1997).

Only limited and expensive technology exists to continuously monitor dissolved ozone at concentrations low enough to be safe for fish. Oxidation–reduction potential probes have also been used, with varying degrees of success, as an indirect means to monitor and control dissolved ozone levels (Bullock et al., 1997).

##### 2.4.2. Seawater applications

Ozone reacts with bromide ions in brackish and seawater systems to form the oxidants hypobromous acid (HOBr) and hypobromite ion ( $\text{OBr}^-$ ), which are relatively stable and toxic to fish and shellfish (Creclius, 1978; Huguenin and Colt, 1989; Blogoslawski and Perez, 1992; Keaffaber et al., 1992). Prolonged ozonation can further oxidize hypobromite ion to bromate ( $\text{BrO}_3^-$ ), which is another persistent and toxic compound. Unfortunately, the production conditions and toxicity towards aquatic animals of these ozonation by-products are not well understood.

#### 2.5. Ozone destruction

Supplying an adequate level of ozone residual at the end of the contact chamber to ensure disinfection will also require that this same ozone be removed prior to the water reaching the aquatic organisms. In many cases, residuals are eliminated by water retention within tanks immediately after ozonation (Fig. 4) or by applying

small doses of a reducing agent, e.g., 1 mg/l of sodium thiosulphate (Hemdal, 1992). Dissolved ozone can also be stripped into air when passed through a forced-ventilation packed aeration column (Fig. 4) (Cryer, 1992; Summerfelt et al., in press). However, air stripping will also remove dissolved oxygen concentrations that are in excess of saturation, which may or may not be desirable. Dissolved ozone can also be destroyed by passing the water through a biofilter or bed of activated carbon, reaction with low levels of hydrogen peroxide, or contact with high intensity UV light (catalyzing the conversion of  $O_3$  to  $O_2$ ). Achieving ozone destruction with UV electromagnetic radiation depends on the wavelength of the UV light source and the quantity of energy transmitted (Rodriguez and Gagnon, 1991; Hunter et al., 1998). Ozone residuals are destroyed at UV light wavelengths ranging from 250 to 260 nm. Ironically, UV wavelengths of 185 nm can be used to generate ozone.

### *2.6. Ozone applications in recirculating aquaculture systems*

Ozone is often used to improve water quality within intensive recirculating systems that are designed to maintain high quality water (Summerfelt et al., 2001), especially within recently constructed salmonid production systems. Ozone is most often applied to recirculating systems at doses that promote water quality improvement (Colberg and Lingg, 1978; Otte and Rosenthal, 1979; Rosenthal and Otte, 1980; Williams et al., 1982; Paller and Lewis, 1988; Rosenthal and Black, 1993; Brazil, 1996; Bullock et al., 1997; Summerfelt and Hochheimer, 1997; Summerfelt et al., 1997; Krumins et al., 2001a,b). This author has reached the following conclusions after considering the above listed research on ozonation within recirculating systems:

- Ozone is thought to impart water quality improvements by oxidizing larger and relatively complex organic molecules and thereby creating smaller and more biodegradable molecules.
- Ozone will break apart refractory organic molecules, which can reduce the color of water.
- Ozone will oxidize nitrite to nitrate.
- Ozonation may enhance fine solids removal by changing particle size (i.e., microfloculating fine particulate matter) and surface properties, which can make particles easier to settle, filter, or float (Reckhow et al., 1993). However, these effects are still not clearly defined.

In addition, ozonation of recirculating systems can reduce fish disease simply by improving water quality, which reduces or eliminates environmental sources of stress (Brazil, 1996; Bullock et al., 1997). These studies, as well as experience with ozone application at numerous commercial recirculating systems, indicates that both water quality and fish health can be improved by adding approximately 13–24 g ozone for every 1.0 kg of feed fed to a recirculating system (Brazil, 1996; Bullock et al., 1997).

### 2.6.1. *More discussion on the use of ozone to oxidize nitrite*

The fact that ozone decreases nitrite levels in a recirculating system is a substantial benefit on those occasions when bacterial conversion of nitrite to nitrate in the biofilter is lost. However, because ozone reduces the nitrite concentration going to the biofilter, it also reduces the quantity of bacteria converting nitrite to nitrate and thus reduces the total acclimated nitrite removal capacity of the biofilter. Nitrite concentrations can rapidly accumulate within fully recirculating systems when ozone addition is interrupted, because ozone can be responsible for removing a fairly large fraction of the total nitrite produced.

In addition, ozone has been occasionally applied to recirculating systems as an afterthought in order to overcome design or operational errors. For example, ozone has been added when biofilters used in recirculating aquaculture systems were found to be incapable of converting all of the nitrite produced into nitrate. These biofilter problems may be due to insufficient surface area (or volume) for completing the two-step nitrification process or may be due to an insufficient supply of dissolved oxygen. Insufficient dissolved oxygen is sometimes caused by poor solids removal that increases heterotrophic respiration within the biofilter. Ozone is then added to these systems as an afterthought to prevent nitrite from accumulating to unsafe levels. However, adding ozone as a fix is not the ideal solution. Ideally, the biofilter will be designed and operated with sufficient surface area and dissolved oxygen to complete the nitrification process, especially when it must treat higher organic and ammonia loading rates. Improved solids control before and within the biofilter will often improve biofilter nitrification and reduce the ozone requirement in many applications.

## 3. UV irradiation

UV irradiation can be used to destroy ozone residuals (catalyzing the conversion of  $O_3$  to  $O_2$ ) and to denature the DNA of microorganisms, causing the microorganisms to die or lose their function. Achieving ozone destruction and microorganism inactivation with UV irradiation depends on the wavelength of the UV light source and the quantity of energy transmitted (Rodriguez and Gagnon, 1991; Hunter et al., 1998). Ozone residuals are destroyed at UV light wavelengths ranging from 250 to 260 nm, while microorganism inactivation can be achieved at UV wavelengths ranging from 100 to 400 nm, although a wavelength of 254 nm is most effective. Low pressure UV bulb systems are almost an industry standard and supply monochromatic irradiation specific to the 254 nm wavelength (Fig. 5). Medium pressure bulb systems are also available, but not as commonly used, to supply a broader UV spectrum (Fig. 6). To achieve a given UV dose, medium pressure UV systems generally require far fewer bulbs (5–20% of the bulbs) but possibly 2–3 times more power than traditional low pressure and low intensity bulb systems. A low pressure but high intensity bulb system has recently been introduced to supply efficient mono-chromatic irradiation that requires only 1/3rd to 1/6th of the bulb required by traditional low pressure and low intensity bulb systems.

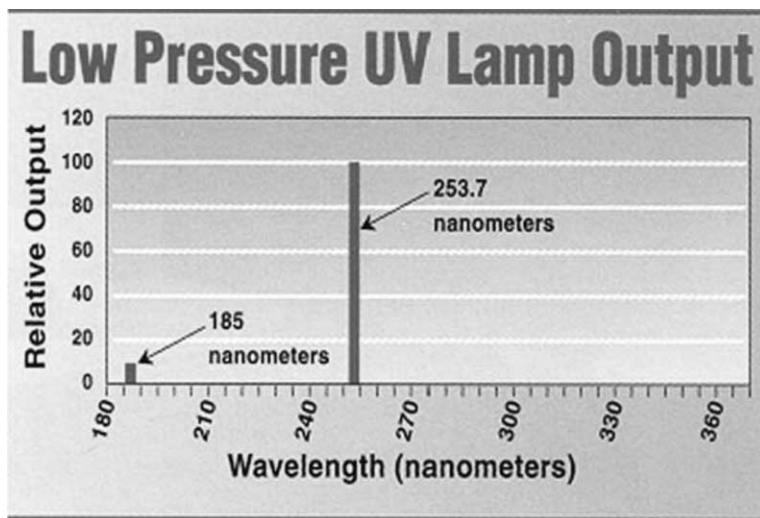

Fig. 5. Nearly monochromatic irradiation specific to the 254 nm wavelength can be supplied by low pressure UV bulb systems (Courtesy of Trojan Technologies, London, Ont., Canada).

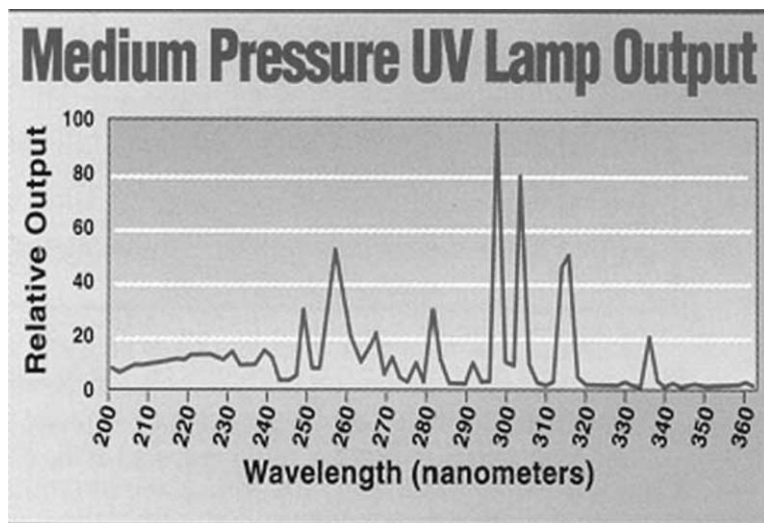

Fig. 6. Medium pressure bulb systems supply a broader UV spectrum (Courtesy of Trojan Technologies, London, Ont., Canada).

UV light intensity is described in terms of  $\text{mW}/\text{cm}^2$  and UV dose in terms of  $\text{mW s}/\text{cm}^2$ . According to White (1992), contact times of 10–30 s are typical of many commercial UV units.

UV doses of 60–75  $\text{mW s}/\text{cm}^2$  have been reported to completely destroy ozone residuals as high as 0.5 mg/l (Hunter et al., 1998). UV doses required to inactivate

microorganisms can vary tremendously, from only 2 mW s/cm<sup>2</sup> to more than 230 mW s/cm<sup>2</sup> (at 254 nm), depending upon the target organism and the required kill rate (Wedemeyer, 1996). Research summarized by Wedemeyer (1996) and Liltved (2001) indicates that many fish pathogens are inactivated by UV doses of 30 mW s/cm<sup>2</sup>, excepting of *Saprolegnia*, white spot syndrome baculovirus, and IPN virus (which require extremely high UV to inactivate).

However, before the UV dose can even reach the target organism, it must be able to transmit through the water. Therefore, the lowest expected UV transmittance of the process water should be established and used to predict how much UV intensity must be generated to transmit the desired UV dose through the water between the target organism and the light source. The UV filter unit should also be sized to account for the 40% decline in bulb intensity that occurs over the typical 12 month expected lamp life.

Achieving UV disinfection requires maintaining a minimum UV dose that is the product of the UV light intensity, the exposure time to this constant intensity, and a transmittance factor (see equation below). Therefore, the actual UV dose applied depends on the water flowrate ( $Q$ ), the operating volume within the UV vessel ( $V_{\text{vessel}}$ ), the lamp intensity (including losses through the quartz sleeve), and the UV transmittance of water (% Transm). An approximate relationship follows:

$$\text{UV dose} = (\text{UV intensity})(\text{exposure time})(\text{transmittance factor})$$

$$\cong (\text{UV intensity}) \left( \frac{V_{\text{vessel}}}{Q} \right) a \exp^{(b\% \text{Transm})}$$

$$= \# \text{mW s/cm}^2$$

where  $a$  and  $b$  are coefficients that are specific to a given UV irradiation unit. The transmittance factor includes a correction for bulb spacing (as well as a correction for other factors), which is of note because UV intensity drops off as a square of the distance between the target organism and the light source (White, 1992).

The UV transmittance of spring water, partial-reuse system water, fully recirculating system water and of the facility's discharge water after microscreen filtration have been monitored at the Freshwater Institute (Table 1). The UV transmittance through the various water sources were found to be greatest in the water taken directly from the spring and degrades with intensity of use and especially with cleaning events (Table 1).

UV filters can be built as non-pressurized open channel units (Fig. 7) or as pressurized tube-and-shell units. The UV bulbs are usually contained within quartz sleeves to allow submergence in the process flow. The quartz sleeves must be kept clean to maintain transmittance (Fig. 7). Using UV light does not produce toxic residuals or form byproducts that pose a risk to aquatic organisms.

Table 1

Average UV transmittance data (across a 1-cm path length) measured on the Freshwater Institute's spring water, partial-reuse system water, fully recirculating system water and of the facility's discharge water after microscreen filtration

Water Source	UV Transmittance	
	Mean (%)	Range (%)
Spring water	97	95–98
Partial-reuse system water	96	88–98
Fully-recirculating system water	93	88–98
<i>Facility discharge</i>		
During normal operation	90	70–95
During cleaning period	40	30–50

Steven Summerfelt, unpublished data.



Fig. 7. Quartz sleeves are cleaned on an open channel UV system (with low pressure/low intensity bulbs) at the Freshwater Institute.

#### 4. Concluding remarks

Care must be used when determining the effective ozone or UV dose that must be supplied to achieve disinfection. Certain pathogens may require much higher UV irradiation doses or higher ozone  $c \times t$  values in order to achieve inactivation.

Applying UV irradiation for disinfection can be both less costly and less complex than using ozone. In addition, UV irradiation does not generate toxic residuals (as does ozone). However, UV irradiation may not work in situations where turbid water (and associated poor UV transmittance) may be encountered.

Applying ozone to disinfect aquaculture system influents or effluents can be quite complex and costly, yet disinfection is still necessary in many situations to control pathogen introduction. The process becomes even more complex if oxygen is produced on-site. However, there are several reasons why adding ozone within recirculating systems may not be as expensive (for a given flow treated) as adding ozone to disinfect aquaculture system influent and effluent flows. For one reason, ozone is not typically added to disinfect water flowing through a recirculating system, therefore, ozone doses added to recirculating flows are typically lower than ozone doses added to disinfect influent and effluent flows. Also, all ozone applications require ozone generation, ozone transfer into solution, contact time for ozone to react, and possibly ozone destruction to ensure that no ozone residual makes it into the culture tanks (as previously mentioned). However, adding ozone to a recirculating system can be less complicated than ozonating a water supply or hatchery effluent, because in recirculating aquaculture systems ozone transfer is sometimes accomplished using the same gas transfer unit that is used for oxygen supplementation—assuming that the transfer unit is fabricated from ozone resistant material (Bullock et al., 1997). In these situations, adding ozone to a recirculating system that is already using purified oxygen only requires installation of an ozone generator and the accompanying ozone distribution, monitoring, and control mechanisms (Summerfelt and Hochheimer, 1997). Most of the other necessary equipment (oxygen supply and distribution system, gas transfer units, and control mechanisms) are already in place. Also, the large ozone demand of the water typically found within a recirculating system causes the ozone dose to react and dissipate rapidly, which minimizes the requirement for a large ozone contactor and a dissolved ozone destruct unit (rapid ozone reaction is also a primary reason why ozone disinfection within recirculating systems is so difficult to achieve). Disinfecting system influent and effluent flows will require large ozone contactors and may also require dissolved ozone destruct units.

## Acknowledgements

Portions of this work were supported through a grant to the Conservation Fund Freshwater Institute from the US Department of Agriculture, Agriculture Research Service. Mention of particular companies or products does not imply endorsement.

## References

- Bablon, G., Bellamy, W.D., Bourbigot, M.-M., Daniel, F.B., Doré, M., Erb, F., Gordon, G., Langlais, B., Laplanche, A., Legube, B., Martin, G., Masschelein, W.J., Pacey, G., Reckhow, D.A., Ventresque, C.,



1991. Fundamental aspects. In: Langlais, B., Reckhow, D.A., Brink, D.R. (Eds.), *Ozone in Water Treatment: Application and Engineering*. American Water Works Association Research Foundation, Denver, CO, pp. 11–132.
- Bellamy, W.D., Damez, F., Langlais, B., Montiel, A., Rakness, K.L., Reckhow, D.A., Robson, C.M., 1991. Engineering aspects. In: Langlais, B., Reckhow, D.A., Brink, D.R. (Eds.), *Ozone in Water Treatment: Application and Engineering*. American Water Works Association Research Foundation, Denver, CO, pp. 317–468.
- Blogoslawski, W.J., Perez, C., 1992. Ozone treatment of seawater to control vibriosis in mariculture of penaeid shrimp, *Penaeus vannameii*. in: Blogoslawski, W.J. (ed.), *Proceedings of the Third International Symposium on the Use of Ozone in Aquatic Systems*. Pan American Group of the International Ozone Association, Stamford, CT, pp. 123–133.
- Brazil, B.L., 1996. Impact of ozonation on system performance and growth characteristics of hybrid striped bass (*Morone chrysops* XM. *saxatilis*) and tilapia hybrids (*Sarotherodon* sp.) reared in recirculating aquaculture systems. Ph.D. Dissertation, Virginia Polytechnic Institute and State University, Blacksburg, VA.
- Bullock, G.L., Summerfelt, S.T., Noble, A., Weber, A., Durant, M.D., Hankins, J.A., 1997. Ozonation of a recirculating rainbow trout culture system: I. Effects on bacterial gill disease and heterotrophic bacteria. *Aquaculture* 158, 43–55.
- Carlins, J.J., Clark, R.G., 1982. Ozone generation by corona discharge. In: Rice, R.G., Netzer, A. (Eds.), *Handbook of Ozone Technology and Applications*, vol. I. Ann Arbor Science Publishers, Ann Arbor, MI, pp. 41–76.
- Colberg, P.J., Lingg, A.J., 1978. Effect of ozonation on microbial fish pathogens, ammonia, nitrate, nitrite, and BOD in simulated reuse hatchery water. *Journal Fisheries Research Board of Canada* 35, 1290–1296.
- Creclius, E.A., 1978. The production of bromine and bromate in seawater by ozonation. *Proceedings of the Symposium on Advanced Ozone Technology*. International Ozone Institute, Norwalk, CT.
- Cryer, E., 1992. Recent applications of ozone in freshwater fish hatchery systems. in: Blogoslawski, W.J. (ed.), *Proceedings of the Third International Symposium on the Use of Ozone in Aquatic Systems*. International Ozone Association, Pan American Committee, Stamford, CT, pp. 134–154.
- Hemdal, J.F., 1992. Reduction of ozone oxidants in synthetic seawater by use of sodium thiosulfate. *Progressive Fish-Culturist* 54, 54–56.
- Huguenin, J.E., Colt, J., 1989. *Design and Operating Guide for Aquaculture Seawater Systems*. Elsevier, Amsterdam.
- Hunter, G.L., O'Brien, W.J., Hulsey, R.A., Carns, K.E., Ehrhard, R., 1998. Emerging disinfection technologies: medium-pressure ultraviolet lamps and other systems are considered for wastewater applications. *Water Environment and Technology* 10 (6), 40–44.
- Keaffaber, J.J., Coston, C.J., Ham, W.G., Burns, T., Sherrill, A., Khan, S., 1992. Redox chemistry of closed ozonated systems: Modeling bromine and other redox active species. in: Blogoslawski, W.J. (ed.), *Proceedings of the Third International Symposium on the Use of Ozone in Aquatic Systems*. Pan American Group of the International Ozone Association, Stamford, CT, pp. 76–91.
- Krumins, V., Ebeling, J., Wheaton, F., 2001a. Part-day ozonation for nitrogen and organic carbon control in recirculating aquaculture systems. *Aquacultural Engineering* 24, 231–241.
- Krumins, V., Ebeling, J., Wheaton, F., 2001b. Ozone's effect on power-law particle size distribution in recirculating aquaculture systems. *Aquacultural Engineering* 25, 13–24.
- Langlais, B., Reckhow, D.A., Brink, D.R., 1991. *Ozone in Water Treatment: Application and Engineering*. American Water Works Association Research Foundation, Denver, CO.
- Liltved, H., 2001. Ozonation and UV-Irradiation. in: Timmons, M.B., Ebeling, J.M., Wheaton, F.W., Summerfelt, S.T., Vinci, B.J. (eds.), *Recirculating Aquaculture Systems*. Northeast Regional Aquaculture Center. Publication No. 01–02. North Dartmouth, MA, pp. 351–382, Chapter 12.
- Masschelein, W.J., 1998. Ozone generation: use of air, oxygen, or air simpsonized with oxygen. *Ozone Science and Engineering* 20, 191–203.
- Occupational Health and Safety Administration. 1993. Air Contaminants Standard, 29 CFR 1910.1000. US Department of Labor, Available from: <http://www.osha.gov/>, Washington, DC.“

- Otte, G., Rosenthal, H., 1979. Management of a closed brackish water system for high density fish culture by biological and chemical treatment. *Aquaculture* 18, 169–181.
- Owsley, D.E., 1991. Ozone for disinfecting hatchery rearing water. in: Colt, J., White, R.J. (eds.), *American Fisheries Society Symposium 10: Fisheries Bioengineering Symposium*. American Fisheries Society, Bethesda, MD, pp. 417–420.
- Paller, M.H., Lewis, W.M., 1988. Use of ozone and fluidized-bed biofilters for increased ammonia removal and fish loading rates. *Progressive Fish-Culturist* 50, 141–147.
- Reckhow, D.A., Edzwald, J.K., Tobiason, J.E., 1993. *Ozone as an Aid to Coagulation and Filtration*. American Water Works Association, Denver, CO.
- Rice, R.G., Robson, C.M., Miller, G.W., Hill, A.G., 1981. Uses of ozone in drinking water treatment. *Journal American Water Works Association* 73, 1–44.
- Rodriguez, J., Gagnon, S., 1991. Disinfection: liquid purification by UV radiation, and its many applications. *Ultrapure Water* 8 (6), 26–31.
- Roselund, B.D., 1975. Disinfection of hatchery influent by ozonation and the effects of ozonated water on rainbow trout. In: Blogoslawski, W.J., Rice, R.G. (Eds.), *Aquatic Applications of Ozone*. International Ozone Institute, Stamford, CT, pp. 59–69.
- Rosenthal, H., 1981. Ozonation and sterilization. In: Tiews, K. (Ed.), *Aquaculture in Heated Effluents and Recirculation Systems*, vol. I. Heenemann Verlagsgesellschaft mbH, Berlin, Germany, pp. 219–274.
- Rosenthal, H., Black, E.A., 1993. Recirculation systems in aquaculture. In: Wang, J.-K. (Ed.), *Techniques for Modern Aquaculture*. American Society of Agricultural Engineers, Saint Joseph, MI, pp. 284–294.
- Rosenthal, H., Otte, G., 1980. Ozonation in an intensive fish culture recycling system. *Ozone: Science and Engineering* 1, 319–327.
- Summerfelt, S.T., Hochheimer, J.N., 1997. Review of ozone processes and applications as an oxidizing agent in aquaculture. *The Progressive Fish-Culturist* 59, 94–105.
- Summerfelt, S.T., Hankins, J.A., Weber, A., Durant, M.D., 1997. Ozonation of a recirculating rainbow trout culture system: II. Effects on microscreen filtration and water quality. *Aquaculture* 158, 57–67.
- Summerfelt, S.T., Vinci, B.J., Piedrahita, R.H., 2000. Oxygenation and carbon dioxide control in water reuse systems. *Aquacultural Engineering* 22, 87–108.
- Summerfelt, S.T., Bebak-Williams, J., Tsukuda, S., 2001. Controlled Systems: water reuse and recirculation. In: Wedemeyer, Gary (Ed.), *Fish Hatchery Management*, Second Ed.. American Fisheries Society, Bethesda, MD.
- Summerfelt, S.T., Bebak-Williams, J., Fletcher, J., Carta, A., Creaser, D. Description of the surface water filtration and ozone treatment system at the Northeast Fishery Center. *Fisheries Bioengineering Symposium IV*. American Fisheries Society, Bethesda, MD, in press.
- Wedemeyer, G.A., 1996. *Physiology of Fish in Intensive Culture*. International Thompson Publishing, New York, NY.
- Wedemeyer, G.A., Nelson, N.C., Yasutake, W.T., 1979. Physiological and biochemical aspects of ozone toxicity to rainbow trout (*Salmo gairdneri*). *Journal of Fishery Research Board of Canada* 36, 605–614.
- White, G.C., 1992. *Handbook of Chlorination and Alternative Disinfectants*. Van Nostrand Reinhold, New York.
- Williams, R.C., Hughes, S.G., Rumsey, G.L., 1982. Use of ozone in a water reuse system for salmonids. *Progressive Fish-Culturist* 44, 102–105.

## EXHIBIT G-1

**Format:** Abstract

Dixon NVC/Upstream 1

**Full text links**Fish Shellfish Immunol. 2008 May;24(5):600-9. doi: 10.1016/j.fsi.2008.01.012. Epub 2008 Feb 8.

## The immune and stress responses of Atlantic cod to long-term increases in water temperature.

Pérez-Casanova JC<sup>1</sup>, Rise ML, [Dixon B](#), Afonso LO, Hall JR, Johnson SC, Gamperl AK.

### Author information

### Abstract

Sea-caged cod are limited in their movements in the water column, and thus can be exposed to large seasonal (approximately 0-20 degrees C) temperature fluctuations. To investigate the physiological response of Atlantic cod to summer-like increases in temperature, we exposed 10 degrees C acclimated juvenile cod to a graded thermal challenge (1 degrees C increase every 5 days) and measured: (1) plasma cortisol and glucose levels; (2) the respiratory burst activity of blood leukocytes; and (3) the expression of specific immune-related genes [MHC Class I, Interleukin-1beta (IL-1beta), beta2-microglobulin (beta2-M), Immunoglobulin M (IgM)-light (L) and -heavy (H) chains] in the blood using quantitative reverse transcription-polymerase chain reaction (QRT-PCR). The experiment was stopped at 19.1 degrees C, with 26.7% of the fish surviving to this point. Plasma glucose levels increased slightly at 16 and 18 degrees C (by 1.39- and 1.74-fold, respectively), in contrast, cortisol levels were elevated significantly (by 2.9-fold) at 16 degrees C but returned to control levels thereafter. The effect of increasing temperature on the expression of immune related genes in blood cells (leukocytes) was variable and depended on the gene of interest. The expression of IgM-H remained stable for the duration of the experiment. In contrast, IL-1beta expression was increased significantly (by approximately 25-fold) at 19 degrees C as compared to time-matched control fish, and changes in the expression of beta2-M, MHC Class I and IgM-L followed a pattern similar to that seen for cortisol: increasing at 16 degrees C (by 4.2-, 5.3- and 17-fold, respectively), but returning to pre-stress levels by 19 degrees C. Interestingly, increasing temperatures had no effect on respiratory burst activity. This study is the first to examine the effects of a chronic regimen of increasing temperature on the stress physiology and immunology of a marine teleost, and suggests that immune function is influenced by complex interactions between thermal effects and temperature-induced stress (elevated circulating cortisol levels).

PMID: 18343685 DOI: [10.1016/j.fsi.2008.01.012](https://doi.org/10.1016/j.fsi.2008.01.012)

[Indexed for MEDLINE]