



June 29, 2018

Mr. James R. Beyer  
Maine Department of Environmental Protection  
Division of Land Resources Regulation  
106 Hogan Road  
Bangor, ME 04401

**RE: Response to January 2018 MDEP Technical Review Memorandum  
New England Clean Energy Connect Project, L-27625-26-A-N**

Dear Mr. Beyer:

Central Maine Power Company (CMP) is pleased to provide this response to the Maine Department of Environmental Protection's (MDEP) January 2018 technical review memorandum (Attachment A) associated with the Site Location of Development Act and Natural Resources Protection Act permit applications submitted by CMP on September 27, 2017, for the New England Clean Energy Connect (NECEC) project. The memorandum contains several comments and requested edits to supporting documents included with the application, including:

- Exhibit 4-1, "Environmental Guidelines for Construction and Maintenance Activities on Transmission Lines and Substation Projects" (CMP Environmental Guidelines)
- Chapter 14, Basic Standards Submissions
- Fickett Road Substation Stormwater Management System
- Merrill Road Converter Station Stormwater Management System

Each of these are discussed below.

**Exhibit 14-1, CMP Environmental Guidelines**

The CMP Environmental Guidelines, enclosed with this letter (see Attachment B), have been revised as requested and as described below:

- 1) Appendix D has been revised to include a typical plan and cross-sectional view of water bars.
- 2) Section 3.1 (page 5) has been revised to include the following language: "In steep terrain, additional erosion and sedimentation control measures will be installed at the low point where the work area drains into the filter strip when exposed soils exist and the flow path may result in channelization of runoff."
- 3) Section 5.0 (page 12) has been revised to include the following language: "In some areas of exposed soils, the right-of-way might be sloped such that runoff traverses the disturbed area. In these areas, temporary water diversions should be deployed to divert the upgradient runoff away from the disturbed work area and towards a stable drainageway." A typical drawing has been prepared and is provided in Appendix D.

- 4) Section 6.0 (page 20, 21) has been revised to include temporary sediment traps and sediment basins. Typical drawings are provided in Appendix D.
- 5) The second paragraph in Section 8.0 (winter construction, page 23) has been revised as requested.
- 6) References to the Maine Erosion and Sediment Control BMPs included in Appendix C have been revised to reflect current guidance documents.

#### **Chapter 14, Basic Standards Submissions**

- 1) Per Kerem Gungor's comments on the "order of construction operations" during the August 17, 2017 working session meeting with MDEP, CMP will adopt the recommendation to establish sediment detention basins prior to full site development at proposed substations for use as temporary sediment traps. The use of sediment basins as temporary sediment traps will be discontinued when the site is determined to be stabilized by CMP environmental inspectors in consultation with MDEP and/or the MDEP third party inspector. All grade cuts, whether in a transmission line ROW or a proposed substation site, will be temporarily or permanently stabilized within 48 hours of initial soil disturbance, or before any predicted storm event, whichever occurs first. To the extent practicable, CMP will limit the extent and duration of exposed soils during site development at proposed substations and during the construction of temporary access roads within transmission line corridors. The extent of soil disturbance at transmission line structure locations will be the minimum required to safely install the structures as defined in Figure 7-1 of the Natural Resources Protection Act application.
- 2) As requested by MDEP, Segment 1 has been evaluated using a GIS analysis of both soil types (soils classified as highly erodible or potentially highly erodible) and percent slope (>22%). Areas with higher erosion risk have been determined (see table below) and will be tracked closely during construction. However, site specific conditions may merit the addition of distinct locations to this list. All areas will be evaluated during pre-construction walkovers with the construction contractors and the MDEP third party inspectors. Any additional high-risk areas identified by CMP environmental compliance inspectors, MDEP third party inspectors, and/or construction management or contractor personnel, during the walkovers or during construction, will be added to the high-risk tracking table. Contractors will be required to have a dedicated erosion and sedimentation control crew in Segment 1 of the Project.

As stated in the application, CMP will inspect higher risk areas with greater frequency and will implement robust and effective environmental controls in these areas including the use of multiple structural erosion and sedimentation control devices in combination with water bars, diversions, and sediment traps, as needed.

The extent and duration of exposed soils within high-risk areas will be limited to the maximum extent practicable.

**Segment 1: Areas with higher erosion risk**

Structure Number	
From	To
3006-11	3006-12
3006-17	3006-19
3006-21	3006-27
3006-28	3006-30
3006-40	3006-43
3006-47	3006-48
3006-50	3006-51
3006-53	3006-60
3006-65	3006-70
3006-74	3006-75
3006-77	3006-79
3006-80	3006-84
3006-87	3006-93
3006-96	3006-97
3006-104	3006-119
3006-130	3006-134
3006-144	3006-148
3006-154	3006-155
3006-167	3006-169
3006-175	3006-176
3006-177	3006-197
3006-199	3006-217
3006-218	3006-229
3006-230	3006-234
3006-235	3006-239
3006-240	3006-258
3006-263	3006-264
3006-266	3006-267
3006-271	3006-287

- 3) MDEP stated that the applicant must submit a stand-alone ESC plan for the Kennebec River crossing (Pole 3006-24 – Pole 3006-21) in accordance with Chapter 500 for the Department’s review. However, since the receipt of Kerem Gungor’s review comments, CMP has modified its proposed crossing at the Kennebec River from a five-structure configuration to a three-structure configuration. As such, the closest structures (3006-21 and 3006-22) on each side of the river are now approximately 775 feet and 850 feet from the rivers edge, respectively. Mature forested buffers of approximately 300 feet and 550 feet will be maintained on southeast and northwest sides of the river, respectively. CMP will install erosion and sedimentation controls downgradient of the structure preparation area on either side of the Kennebec River crossing.

It is anticipated that the limited soil disturbance at these sites, the installation of erosion and sedimentation controls, and the preservation of mature forested buffers between these structures and the river will be sufficient to prevent any discharge of sediments to the river. CMP will implement erosion and sedimentation controls at the structure locations adjacent to the Kennebec River, as well as at structure preparation areas with higher risk of erosion, consistent with the attached typical figure (see Attachment C).

### **Fickett Road Substation Stormwater Management System**

#### Basic Standards

- 1) MDEP recommended using erosion control blankets or erosion control mix for stabilization of the slopes steeper than 8% (particularly for 1:3 (H:V) slopes) and revision of the mulching sections of the notes given in Site Details 5 (Sheet 5 of 5). On Site Details 5 (Sheet 5 of 5), Construction Sequence Note 10 has been modified to require erosion control blankets or erosion control mix for slopes greater than 8%.
- 2) As requested by MDEP, a complete Housekeeping Plan, consisting of text from Chapter 500 Appendix C modified for the project, has been added to Site Details 4 (Sheet 4 of 5).

#### Phosphorus Standards

- 1) As requested by MDEP, Worksheet 1 and other submittals have been updated to reflect a per acre phosphorus allocation of 0.030 lb/acre/year.
- 2) MDEP requested that treatment factor (TF) values smaller than one (1) be replaced with 0.1. TF. This has been updated to reflect a minimum of 0.1 throughout the calculations package.
- 3) Worksheet 4 (Project Phosphorus Export Summary) has been completed as requested and is included with the updated calculations.



- 4) Since the low phosphorus export coefficient (0.4 lb/ac/yr for Hydrologic Soil Group D soil) was used for the proposed lawn, CMP needs to put a phosphorus use restriction on the deed per Maine Stormwater BMP Manual Volume II Chapter 3. The deed restriction will prohibit the use of fertilizers containing phosphorus except when establishing new vegetation on bare soil. CMP has added the restrictions on the use of phosphorus fertilizer to the post-construction stormwater inspection & maintenance checklist for the Revegetated Areas (Appendix A-1).

### **Merrill Road Converter Station Stormwater Management System**

#### Basic Standards

- 1) As requested by MDEP, a complete Housekeeping Plan, consisting of the text from Chapter 500 Appendix C modified for the project, has been added to Sheet 5 of 6.
- 2) MDEP recommends geogrid for the cut slope at the southeastern side of the converter station. CMP will follow the recommendations in the Merrill Road Proposed Converter Station Draft Geotechnical Report by S.W. Cole Engineering, Inc. dated May 11, 2018. As such, slopes of 1:3 (V:H) will be surfaced with erosion control blankets, loam and seed (SS 4.4.2 and 4.4.5)
- 3) On Site Details (Sheet 6 of 6), the “Fertilizer and Limestone Requirements” have been revised as requested by MDEP. The fertilizer and lime application rates shall be determined using site-specific soil test results.
- 4) As requested by MDEP, On Site Details (Sheet 6 of 6), Construction Sequence Note 11 has been modified to require erosion control blankets and/or erosion control mix for slopes greater than 8%.

#### General Standards

- 1) A groundwater collection system and foundation drain, consisting of perforated PVC piping, has been added beneath the portion of the pad that requires excavation and may experience elevated groundwater conditions. The system will control the groundwater elevation to a level that is, at minimum, 18” below the top of gravel. Collected groundwater is conveyed from beneath the gravel and away from the building foundation and off-site. See updated Sheet 1076-003-002 SH 002 for sections representing the groundwater collection system and foundation drain, and updated Sheet 1076-003-02 SH 004 for the layout. This proposed design complies with MDEP’s substation yard approval letter that states that groundwater should not be any higher than 18” below the top of the gravel fill.
- 2) MDEP requested confirmation that elevations A and B are accurate in the schedule presented for CB 1 and CB 2 in Stormwater Treatment Plan (Sheet 2 of 4). Elevations shown for CB 1 and CB 2 are correct. Elevation A represents the permanent grate elevation, while Elevation B represents the bottom of the manhole/concrete anti-floatation slab. For invert elevations for the soil filter outlet structures, refer to the Soil



**CENTRAL MAINE  
POWER**

Filter Outlet Structure detail and associated Elevation/Geometry table on Sheet 1076-003-002 SH 002.

- 3) Loamy coarse sand specifications per Table 7.1.3 of the Maine Stormwater BMP Manual Chapter 7.1 have been added to the updated Sheet 1076-003-002 SH 002, as requested.
- 4) As requested by MDEP, orifices have been added to the soil filter underdrains at the connection to the catch basins. Orifices will release water between 24-48 hours. Sheet 1076-003-002 SH 002 has been revised. In the SOIL FILTER OUTLET STRUCTURE ELEVATIONS/GEOMETRY, letters J and K represent the orifice invert elevation and diameter, respectively. Orifice calculations have been added to the updated Stormwater Report.

The revised stormwater plans and site detail sheets described above are included as Attachment D and E of this response.

If you have any questions regarding these responses, please give me a call at (207) 629-9717 or email [gerry.mirabile@cmpco.com](mailto:gerry.mirabile@cmpco.com).

Sincerely,

Gerry J. Mirabile  
Manager – Environmental Projects  
Environmental Permitting  
AVANGRID Networks, Inc.

Enclosures

cc: Naomi Kirk-Lawlor, Samantha Horn, Bill Hinkel - LUPC; Jay Clement - USACE;  
Christopher Lawrence, Melissa Pauley - USDOE; Bernardo Escudero - CMP; Mark  
Goodwin - Burns & McDonnell; Matt Manahan, Jared des Rosiers - Pierce Atwood  
File: New England Clean Energy Connect

**ATTACHMENT A**  
**MDEP Technical Review Memorandum – January 2018**

## TECHNICAL REVIEW MEMORANDUM

*Bureau of Land Resources*

TO: **Jim Beyer, Project Manager – Bureau of Land Resources**  
FROM: **Kerem Gungor, Environmental Engineer-- Bureau of Land Resources**  
RE: **Central Maine Power Company, New England Clean Energy Connect,  
L-27625-26-A-N**  
DATE: **January, 2018**

I have reviewed the new Site Location of Development Act (SLODA) permit application submitted by the *Central Maine Power Company (CMP)* for the New England Clean Energy Connect (NECEC) project. The SLODA permit application was received and accepted by the Department on 9/27/17 and 10/13/17, respectively. Following Natural Resources Protection Act (NRPA) permit applications were also made due to the scale of NECEC: L-27625-TG-B-N, L-27625-2C-C-N, L-27625-VP-D-N, and L-27625-IW-E-N. This review was performed to determine NECEC SLODA permit application's compliance with Maine Stormwater Management Rules (Chapter 500). Some of the materials enclosed with the NRPA permit application were also reviewed to have a better understanding of the potential stormwater impacts on the protected natural resources and provide technical feedback to improve the proposed stormwater management plan.

**APPLICANT:** CMP

**DEP#:** L-27625-26-A-N

**Primary Contact for the Applicant:** Gerry Mirabile

**Project description:** NECEC which mainly includes transmission line construction and improvements, substation improvements, one new converter station and one new substation construction

**Resultant impervious area<sup>1</sup>:** 12.55 ac

**Resultant developed area<sup>2</sup>:** 19.27 ac

**Standards applicable to the project:** Basic, flooding, general, phosphorus, and redistribution of stormwater discharges.

### **A. PROJECT SUMMARY**

*Central Maine Power Company (CMP)* proposes to construct the *New England Clean Energy Connect (NECEC)* project which includes a *High Voltage Direct Current (HVDC)* transmission line with a maximum capacity of 1,200 MW and its facilities. The longest section of NECEC will extend from Quebec Border southerly to Pownal. NECEC is a large-scale project with linear and non-linear components. Linear component of the project includes new transmission line construction and existing transmission line reconstruction. Total length of the new and rebuilt transmission lines will be approximately 201.1 miles. Approximately 28.1 miles of existing transmission line will be rebuilt, which is exempt from SLODA

---

<sup>1</sup> Proposed transmission line work and existing substation improvements will not create jurisdictional impervious area. Therefore, the given resultant impervious area figure is the total figure for the two new substations: 3.90 ac for Fickett Road; 7.15 ac (substation pad) + 1.50 ac (access road) for Merrill Road substations.

<sup>2</sup> Proposed transmission line work and existing substation improvements will not create jurisdictional developed area. Therefore, the given resultant developed area figure is the total figure for the two new substations: 10.71 ac (substation pad) + 3.69 ac (access road) for Merrill Road; 4.87 ac (total) for Fickett Road substations.

pursuant to 38 M.R.S. §488. The construction activities will take place in a transmission corridor stretching approximately 193 miles. The linear component of the project is comprised of five segments (Table 1-1).

### 1. Linear Component Segments:

- Segment 1: 150-ft wide new clearing is proposed in 300-ft wide new right-of-way (ROW) stretching approximately 53.5 miles from Quebec Border/Beattie Township to the Forks Plantation. Above-ground height of the proposed poles is 100 ft (See *Segment 1* detail drawing in *Attachment 1*). No transmission line rebuild is proposed. Various degrees of vegetation clearing will take place in 973 acres of the new ROW.
- Segment 2: Total length of the segment is 21.9 miles extending from the Forks Plantation to Wyman Hydro Substation in Moscow. Seventy-five ft of the existing 300-ft wide ROW will be cleared for a stretch of 20.7 miles. Eighty ft of the existing 300-ft wide ROW will be cleared for the remaining part of the segment. No transmission line rebuild is proposed. Total area to be cleared within the existing ROW is approximately 199 acres.
- Segment 3: Total length of the segment is 71.1 miles extending from Wyman Hydro Substation in Moscow to the existing Larrabee Road Substation in Lewiston. Proposed clearing width is mostly 75 ft within the existing ROW, which ranges from 340 to 500 ft. Only 0.8-mile of transmission line rebuild (CMP Section #72) is proposed. Approximately 639 acres of the existing ROW will be cleared.
- Segment 4: Total length of the segment is 16.4 miles extending from the existing Larrabee Road Substation in Lewiston to a new substation on Fickett Road in Pownal. New transmission line construction will be limited to only 0.3 mile (CMP Section #3005). Proposed transmission line rebuild is 25.4 miles (CMP Sections #62 & #64). All the construction will take place within the existing ROW ranging between 340 and 400 ft. No clearing is proposed.
- Segment 5: Total length of the segment is 26.5 miles extending from the existing Coopers Mills Substation to the existing Maine Yankee Substation in Wiscasset. Twenty-six and a half miles of new transmission line (CMP Section #3027) will be built within the existing ROW ranging from 270 to 640 ft. There will be 1.9-mile-long transmission line rebuild work. No clearing is proposed.

In addition to the segments given above, the proposed Merrill Road substation in Lewiston will have a linear portion (i.e. access road) of 1.50 acres.

### 2. Non-linear Component: Substations

CMP proposes to construct two new substations, namely *Merrill Road Converter Station* and *Fickett Road Substation*, for NECEC project. Merrill Road Converter Substation will be northerly from Merrill Road in Lewiston. The converter substation pad or yard will be 10.71 acres in size and located adjacent to the transmission corridor. Fickett Road Substation will be near Surowiec Substation in Pownal. The substation area will be approximately 4.87 acres.

New equipment will be installed in some of the existing CMP substations to satisfy the NECEC infrastructure requirements. Concrete foundations to support the new equipment will result in an increase in the impervious area of the following substation yards:

- Coopers Mills Substation (Windsor): 12,000 sf of new impervious area,
- Larrabee Substation (Lewiston): Approximately 3,500 sf of new impervious area,
- Maine Yankee Substation (Wiscasset): Approximately 900 sf of new impervious area,
- Surowiec Substation (Pownal): Approximately 450 sf of new impervious area,
- Raven Farm Substation (Cumberland): Approximately 2,200 sf of new impervious area.

#### **A. Submitted Materials Used for the Technical Review:**

Electronic application files of the NECEC project were made available to the public on <http://www.maine.gov/dep/land/projects/necec/index.html>. I obtained the following components of the SLODA permit application package from the web address and used them in my review:

- Chapters:
  - Chapter 1. Development Description.
  - Chapter 10. Buffers.
  - Chapter 11. Soils.
  - Chapter 12. Stormwater Management.
  - Chapter 14. Basic Standard Submissions.
- Attachments:
  - Attachment 1. Transmission Line Cross Sections.
  - Attachment 4. Floodplain and Soils.

Plan sheets enclosed with the stormwater management system portable document files (PDFs) submitted for the proposed (new) *Merrill Road Converter Substation* and *Fickett Road Substation* are listed below:

- Merrill Road Complete.pdf:
  - Sheet 3 of 4. Pre-development Stormwater Plan. Unsealed.
  - Sheet 4 of 4. Post-development Stormwater Plan. Unsealed.
  - Sheet 1 of 2. General Site Plan Existing Conditions.
  - Sheet 2 of 2. General Site Plan Proposed Conditions.
  - Sheet 1 of 4. Grading Plan.
  - Sheet 2 of 4. Stormwater Treatment Plan.
  - Sheet 3 of 4. Pre-development Stormwater Plan.
  - Sheet 4 of 4. Post-development Stormwater Plan.
  - Sheet 1 of 2. Erosion and Sediment Control Plan 1.
  - Sheet 2 of 2. Erosion and Sediment Control Plan 2.
  - Sheet 1 of 3. Road Plan and Profile 1.
  - Sheet 2 of 3. Road Plan and Profile 2.
  - Sheet 3 of 3. Road Plan and Profile 3.
  - Sheet 1 of 6. Site Details 1.
  - Sheet 2 of 6. Site Details 2.
  - Sheet 3 of 6. Site Details 3.
  - Sheet 4 of 6. Site Details 4.
  - Sheet 5 of 6. Site Details.

- Sheet 6 of 6. Site Details.

Above plan sheets were dated 9/8/17, signed and sealed by *Kenneth R. Volock, P.E.* unless stated otherwise.

- *Fickett Road Complete.pdf*
  - Sheet 1 of 2. General Site Plan Existing Conditions. 9/13
  - Sheet 2 of 2. General Site Plan Proposed Conditions. 9/13
  - Sheet 1 of 1. Grading Plan.
  - Sheet 1 of 3. Stormwater Treatment Plan.9/13
  - Sheet 2 of 3. Pre-development Stormwater Plan. 9/13
  - Sheet 3 of 3. Post-development Stormwater Plan. 9/13
  - Sheet 1 of 1. Erosion and Sediment Control Plan.
  - Sheet 1 of 5. Site Details 1.
  - Sheet 2 of 5. Site Details 2. 9/13.
  - Sheet 3 of 5. Site Details 3. 9/13.
  - Sheet 4 of 5. Site Details 4. 9/13.
  - Sheet 5 of 5. Site Details 5. 9/13.

Above plan sheets were dated 9/13/17, signed and sealed by *Kenneth R. Volock, P.E.*

## **STORMWATER MANAGEMENT**

### **A. Basic Standards**

**Note:** *As always, the applicant's erosion control plan is a good starting point for providing protection during construction. However, based on site and weather conditions during construction, additional erosion and sediment control measures may necessary to stop soil from leaving the site. In addition, other measures may be necessary for winter construction. All areas of instability and erosion must be repaired immediately during construction and need to be maintained until the site is fully stabilized or vegetation is established. Approval of this plan does not allow unauthorized discharges from the site.*

#### **1. Transmission Line**

The applicant proposes vegetation clearing for *Segment 1, Segment 2, and Segment 3*. No clearing is proposed for *Segment 4 and Segment 5*. Approximate clearing area, as proposed, descends in the following order: *Segment 1* (973 acres), *Segment 3* (639 acres), and *Segment 2* (199 acres). *Segment 1* is constituted by a new right-of-way (ROW) which is 300 ft wide. The applicant proposes to clear half of the ROW for NECEC. Considering the segments' characteristics -especially clearing areas-, a special emphasis must be given on the *Segment 1* in terms of erosion and sedimentation control (ESC).

#### ***Comments:***

1. I recommend following amendments and revisions for Exhibit 14-1 "Environmental Guidelines for Construction and Maintenance Activities on Transmission Lines and Substation Projects" enclosed with the application:
  - a. Water bars are important and commonly used erosion control measures for the linear projects. To facilitate their proper construction, please amend "Appendix D. Construction Technique Illustrations" with typical plan and cross-sectional view of the water bars,
  - b. Certain sections of the transmission projects are sloped such that the runoff traverses the ROW. Temporary water diversion structures can be deployed in these sections to divert the upgradient runoff away from the disturbed work area and towards a stable drainageway. Please amend Section 5.0 (page 11) to incorporate the upgradient runoff diversion and provide a typical drawing in Appendix D. Section 4.0 of "Maine Erosion and Sediment

Control Best Management Practices (BMPs) Manual for Designers and Engineers (October 2016)” can be used as a reference,

- c. Temporary sediment basins can be necessary where the runoff flows along the transmission line in high-pitch ROWs and concentrates in a low spot which may have protected natural resources. In such areas, temporary sediment basins can be installed to -at a minimum- detain the runoff due to major storm or snowmelt events and control sedimentation. Please amend Section 6.0 to include temporary sediment basins and provide a typical drawing in Appendix D,
  - d. Although it is always advisable to use common sense when implementing ESC measures, Chapter 500 Appendix A(7) clearly requires the implementation of additional winter construction ESC measures between November 1 and April 15. Therefore, please revise second paragraph in Section 8.0 accordingly,
  - e. The DEP reference given in Appendix C has been superseded with the following documents. Please revise the reference accordingly and update the citations within the text:
    - o Maine Erosion and Sediment Control Best Management Practices (BMPs). Manual for Designers and Engineers. Bureau of Land Resources, Maine Department of Environmental Protection, Augusta, Maine. October 2016.  
[http://www.maine.gov/dep/land/erosion/escbmps/esc\\_bmp\\_engineers.pdf](http://www.maine.gov/dep/land/erosion/escbmps/esc_bmp_engineers.pdf)
    - o Maine Erosion and Sediment Control Practices Field Guide for Contractors. Bureau of Land Resources, Maine Department of Environmental Protection, Augusta, Maine. 2014.  
[http://www.maine.gov/dep/land/erosion/escbmps/esc\\_bmp\\_field.pdf](http://www.maine.gov/dep/land/erosion/escbmps/esc_bmp_field.pdf)
  - f. Section 3.1 (Page 5): Runoff typically channelizes when the flow path length exceeds 100 ft. Channelization can happen even at a shorter flow path length in the presence of steep slopes. Therefore, increasing filter strip width as a function of slope may not deliver the desired outcome by itself. It is important to scope the filter strips in steep terrain for drainageways and make sure that turbid runoff from the disturbed area does not discharge into a drainageway which may result in a short-circuiting and sedimentation in the resource. Implementation of additional structural measures at the low point where the work area drains into the filter strip (e.g. multiple layers of sediment barriers, temporary sediment basins) becomes necessary in such cases. Please revise Section 3.1 accordingly.
2. Chapter 14 (Page 14-2): Please specify what kind of changes will be made on the “order of construction operations” per my recommendations.
3. Using the GIS data provided by the applicant on ArcGIS platform, I performed a preliminary spatial analysis to the sections of *Segment 1* with relatively high slope (>22%). Based on my preliminary analysis on the slopes, the applicant must allocate more resources for ESC in the following sections of *Segment 1*:

Pole #		ESC Notes for the Section
From	To	
3006-287	3006-271	Mill Brook crossing (3006-280 to 3006-279). Valley bottom where runoff concentrates.
3006-217	3006-202	Upgradient runoff diversion will be necessary.
3006-116	3006-105	Steep slope to stream. Sediment basin can be necessary (3006-113 to 3006-112)



3006-91	3006-88	Frequently placed water bars and upgradient flow diversion can be satisfactory for this section.
3006-24	3006-21	<b>Kennebec River Crossing</b>

I strongly recommend the applicant to perform a complete GIS analysis including both soils and topographic data on *Segment 1* to determine the areas with high erosion risk. The high-risk areas must

- Receive a higher frequency of environmental inspection as outlined in page 14-3 of the application,
- Have a dedicated ESC maintenance crew,
- Have additional structural ESC measures which can include multiple layers of sediment barriers, upgradient flow diversion structures, and temporary sediment basins depending on the location,
- Have an accelerated work schedule to the maximum extent practicable.

The applicant must submit a stand-alone ESC plan for the Kennebec River crossing (Pole 3006-24 – Pole 3006-21) in accordance with Chapter 500 for the Department’s review.

#### 4. Substations

##### a. Merrill Road Substation

An erosion and sedimentation control (ESC) plan has been prepared for the proposed *Merrill Road Converter Substation* by *Power Engineers*. Related information was provided in the following plan sheets (see [Merrill Road Complete.pdf](#) for the plan sheets):

- **Location plan** presented in *Erosion and Sediment Control Plan 1 & 2 (Sheet 1 of 2 & Sheet 2 of 2)*
- **Erosion and sedimentation control notes** presented in *Site Details (Sheet 6 of 6)*
- **Construction and installation details** presented in *Site Details 2 (Sheet 2 of 6), Site Details 4 (Sheet 2 of 6)*

##### Comments:

1. Some of the housekeeping plan components have been addressed in *Site Details (Sheet 6 of 6)*. Please make sure that other housekeeping components (i.e., spill prevention, groundwater protection, debris and other materials, authorized non-stormwater discharges) are also covered under a separate section titled *Housekeeping Plan* per *Chapter 500 Appendix C*.
2. The applicant proposes a 1:3 (V:H) cut slope at the southeastern side of the substation. Maximum linear length of the slope will be approximately 130 ft. I recommend installing geogrid for this section of the slope to minimize potential sliding, slumping, or rilling that can particularly occur before the minimum 90% vegetation cover is attained.
3. Please revise *Fertilizer and Limestone Requirements* section of *Site Details (Sheet 6 of 6)*: “The fertilizer and lime application rates shall be determined using the site-specific soil test results.”
4. Considering the southeastern 1:3 (V:H) cut embankment and its slope length, I recommend limiting the applicable erosion control measures to erosion control blankets and erosion control mix for the slopes steeper than 8% in the site. Please revise *Site Details (Sheet 6 of 6)* accordingly.

##### b. Fickett Road Substation

An ESC plan has been prepared for the proposed *Fickett Road Substation* by *Power Engineers*. Related information was provided in the following plan sheets:

- **Location plan** presented in *Erosion and Sediment Control Plan (Sheet 1 of 1)*
- **Erosion and sedimentation control notes** presented in *Site Details 5 (Sheet 6 of 6)*
- **Construction and installation details** presented in *Site Details 1 thru Site Details 4 (Sheet 1 of 5 thru Sheet 4 of 5)*

**Comments:**

1. I recommend using erosion control blankets or erosion control mix for the stabilization of the slopes steeper than 8% (particularly for 1:3 (H:V) slopes). Please revise the construction sequence, mulching sections of the notes given in *Site Details 5 (Sheet 5 of 5)* accordingly.
2. Some of the housekeeping plan components have been addressed in *Site Details (Sheet 6 of 6)*. Please make sure that other housekeeping components (i.e., spill prevention, groundwater protection, debris and other materials, authorized non-stormwater discharges) are also covered under a separate section titled *Housekeeping Plan* per Chapter 500 Appendix C.

**B. General Standards**

**a. Merrill Road Substation**

The proposed substation yard will result in 7.15 and 10.71 ac of impervious and developed area, respectively. The proposed access road will result in 3.69 ac of developed area 1.50 ac of which will be impervious.

The applicant proposes to treat the linear portion of the project (i.e. access road) using a grassed underdrained soil filter (GUSF). The proposed filter will treat 75.10 and 59.89% of the impervious and developed area pursuant to Chapter 500 Section 4(C)(5)(c). The applicant also proposes to build another GUSF westerly from the proposed substation yard for stormwater treatment purposes. The proposed GUSFs can be seen in the Post-development Stormwater Plan (*Sheet 4 of 4*). The CMP substation yard is considered as a “self-treating” impervious surface pursuant to the Department’s letter dated 6/5/2008 and signed by *Don Witherill* (pp. 17-18 in *Merrill Road Complete.pdf*). Based on the areal breakdown of *Subbasin A2* and *A3* land covers, total area of the substation yard, excluding the other impervious areas within it, will be 4.17 ac. Other impervious surfaces (i.e. paved surfaces, roofs, concrete foundations) enveloped by the substation yard will be 2.94 ac. The substation yard will provide sufficient storage volume (*ca.* 109,000 cf) to retain 1” of the runoff from the other impervious surfaces (*ca.* 10,700 cf).

**Comments:**

1. As written in the Department’s substation yard approval letter, groundwater should not be any higher than 18” below the top of the gravel fill. A portion of the proposed substation will have a final grade lower than the existing grade as shown in *Substation Yard Section A-A (Site Details 1, Sheet 1 of 6)*. Please provide an analysis demonstrating that the proposed design will satisfy the letter’s condition.
2. Please verify that the elevations *A* and *B* are accurate in the schedule presented for *CB 1* and *CB 2* in *Stormwater Treatment Plan (Sheet 2 of 4)*.
3. Please provide the loamy coarse sand specifications per Table 7.1.3 of *Maine Stormwater BMP Manual* Chapter 7.1.

4. Release time of the filters must be adjusted to 24-48 h by using an orifice or a ball valve. Please revise Stormwater Treatment Plan (*Sheet 2 of 4*) accordingly.

### C. Phosphorus Standard

#### a. Fickett Road Substation

The proposed substation will discharge into *Runaround Brook*, a tributary of *Runaround Pond*. *Runaround Pond* is the first pond, which fits the description given in Chapter 500 Section 3(N), downstream the proposed project. The pond is listed as a lake most-at-risk from new development in Chapter 502.

The 2-ft deep substation yard specifications of which have been approved by the Department will provide ample storage volume for the impervious roof and concrete surfaces to be built within the substation yard: One-inch storage volume required for the impervious roof and concrete surfaces is approximately 1,053 cf. The substation yard will provide 90,430 cf of storage volume.

#### Comments:

1. *Jeff Dennis* (DEP Watershed Management Unit) determined *per acre phosphorus allocation* for Runaround Pond watershed within New Gloucester town as 0.030 lb/acre/yr. Please revise the first worksheet including the project's phosphorus budget (PPB) calculations and other submittals including the PPB value (e.g. *Sheet 3 of 3*) accordingly.
2. Minimum allowable treatment factor (TF) is 0.1 as shown in Table 4.1 of Maine Stormwater Management Design Manual Volume II. Hence, TF values smaller than 0.1 must be replaced with 0.1 and the project phosphorus export (PPE) values must be recalculated in Worksheet 2.
3. Please fill out and submit "Project Phosphorus Export Summary (Worksheet 4)". A template worksheet is available from <http://www.maine.gov/dep/land/stormwater/stormwaterbmps/index.html>.
4. Since the low phosphorus export coefficient (0.4 lb/ac/yr for Hydrologic Soil Group D soil) was used for the proposed lawn, the applicant needs to put a phosphorus use restriction on the deed per *Maine Stormwater BMP Manual Volume II Chapter 3*. The deed restriction will prohibit the use of fertilizers containing phosphorus except when establishing new vegetation on bare soil. Please mention the phosphorus containing fertilizer restriction in the post-construction stormwater inspection & maintenance checklist (Appendix A-1).

#### b. Surowiec Substation

The existing substation is in the direct watershed of *Runaround Pond*. The pond is listed as a lake most-at-risk from new development in Chapter 502. The approved project phosphorus budget (PPB) and the post-treatment project phosphorus export (post-PPE) are 2.19175 and 0.4225 lbs P/yr, respectively. The proposed improvements will replace approximately 0.01 ac of the substation yard with concrete foundations, which will increase the pre-treatment project phosphorus export (pre-PPE) by 0.005 lbs P/yr. Under the proposed conditions, the post-PPE will remain smaller than the PPB.

The proposed improvements at the substation comply with Chapter 500 Section 4(D).

### D. Flooding Standard

#### a. Fickett Road Substation

The applicant created pre- and post-development hydrologic models for the project site using SCS TR-55 method. The pre-development model consisted of four subbasins (A thru D) as shown in *Sheet 2 of 3*. The post-development model consisted of five subbasins (A, B-1, B-2, C, D) as shown in *Sheet 3 of 3*. The project will impact all subbasins except Subbasin D. The peak flows off the project site were assessed at four analysis points.

The model results showed that the post-development peak flows would not exceed the pre-development peak flows for 2-, 10-, and 25-yr storms. The applicant also demonstrated that the proposed 15-inch culvert, which will be installed under the access road connecting to Fickett Road, was capable of handling 25-yr storm peak flow (page 27 in *Fickett Road Complete.pdf*).

The proposed substation project complies with Chapter 500 Section 4(F).

**b. Merrill Road Substation**

The applicant created pre- and post-development hydrologic models for the project site using SCS TR-55 method. The pre-development model consisted of five subbasins (A thru E) as shown in *Sheet 3 of 4*. The post-development model consisted of eight subbasins (A1, A2, A3, B, C1, C2, D, E) as shown in *Sheet 4 of 4*. The peak flows off the project site were assessed at five analysis points: A thru E. The model results showed that the post-development peak flows would not exceed the pre-development peak flows for 2-, 10-, and 25-yr storms. The applicant also demonstrated that the proposed culverts were capable of handling 25-yr storm peak flow (page 131 in *Merrill Road Complete.pdf*).

The proposed substation project complies with Chapter 500 Section 4(F).

**c. Substation Improvements**

i. Coopers Mills Substation

The applicant provided modeling results demonstrating that the improvements (i.e. 0.275-ac new impervious area within the existing substation yard) at this substation would increase the area-weighted curve number by one point (61 vs. 62). The maximum peak flow increase (proposed vs. existing) was simulated to be 1.1%. The peak flows for 2-, 10-, and 25-yr storms under the proposed condition would remain significantly smaller than the pre-development peak flows (Subsection 12.1.3.1.5 of the application).

ii. Larrabee Substation

The applicant provided modeling results demonstrating that the improvements (i.e. 0.08-ac new impervious area within the existing substation yard) at this substation would not increase the area-weighted curve number, which was 56. Therefore, the post-development peak flows for 2-, 10-, and 25-yr storms would remain the same with those of the existing condition (Subsection 12.1.3.3.5 of the application).

iii. Yankee Substation

The applicant provided modeling results demonstrating that the improvements (i.e. 0.02-ac new impervious area within the existing substation yard) at this substation would not increase the area-weighted curve number, which was 69. Therefore, the post-development peak flows for 2-, 10-, and 25-yr storms would remain the same with those of the existing condition (Subsection 12.1.3.4.5 of the application).

iv. Surowiec Substation

The applicant provided modeling results demonstrating that the improvements (i.e. 0.01-ac new impervious area within the existing substation yard) at this substation would not increase the area-weighted curve number, which was 68. Therefore, the post-development peak flows for 2-, 10-, and 25-yr storms would remain the same with those of the existing condition (Subsection 12.1.3.5.5 of the application).

v. Raven Farm Substation

The applicant declared that half of the development previously approved by the Department was constructed at this substation site. The new impervious area (approximately 0.05 ac) and the new substation yard (3.52 ac) proposed for NECEC will not exceed the previously approved level for the Maine Power Reliability Project (MPRP).

The improvement projects will not have a noticeable impact on the 2-, 10-, and 25-yr post-development peak flows off the substations. Hence, the proposed substation improvements comply with Chapter 500 Section 4(F).

**E. Redistribution of Stormwater Discharges Standard**

**a. Merrill Road Substation**

The applicant proposes to build four level spreaders to convert concentrated stormwater flow into sheet flow:

- Level Spreader-1 (LS-1) at the outlet of Grassed Underdrained Soil Filter #2 as shown in Road Plan and Profile (*Sheet 1 of 3*),
- Level Spreader-2 (LS-2) southerly from the substation yard receiving runoff from the perimeter swale as shown in General Site Plan Proposed Conditions (*Sheet 2 of 2*),
- Level Spreader-3 (LS-3) between the Stations 20+00 and 21+00 at the culvert outlet as shown in Road Plan and Profile 2 (*Sheet 2 of 3*),
- Level Spreader-4 (LS-4) between the Stations 18+00 and 19+00 at the culvert outlet as shown in Road Plan and Profile 2 (*Sheet 2 of 3*).

The proposed lip length for the level spreaders was 10 ft exceeding the minimum lip length calculated using the standard: 0.25 cfs per linear foot lip for 10-yr, 24-h storm peak flow.

The proposed level spreaders comply with Chapter 500 4(H).

**ATTACHMENT B**

**Exhibit 4-1, “Environmental Guidelines for Construction and Maintenance  
Activities on Transmission Lines and Substation Projects” (Revised)**



**Environmental Guidelines  
For Construction and Maintenance  
Activities on Transmission Line  
And Substation Projects**

*Prepared for:*

**Central Maine Power Company  
83 Edison Drive  
Augusta, Maine 04336**

*Prepared by:*

**TRC Engineering, LLC  
249 Western Avenue  
Augusta, Maine 04330**

## DOCUMENT REVISION LOG

<b>Rev.</b>	<b>Section</b>	<b>Description</b>	<b>Appv'd by</b>	<b>Date</b>
-	All	Initial Release		1992
-	All	Update Document Prepared by EPRO	G. Mirabile	Nov 2000
-	Multiple	Update to correspond to DEP Guidelines	G. Mirabile	Dec 2007
-	3, 5	Update to correspond to DEP Guidelines	G. Mirabile	May 2011
1	All	Converted to ISO Controlled Document	G. Mirabile	Oct 2012
2	All	Changed Doc Type from SOP to Reference	R. Koster	Mar 2015
3	9 & Appendix A	Revised Section 9.2.5 and 9.2.7 (Restoration Methods), and Appendix A (Temporary Access Road definition)	G. Mirabile	August 2016
4	Various	Consistency with latest MDEP BMPs	G. Mirabile	June 2018



## TABLE OF CONTENTS

<b>1.0 INTRODUCTION .....</b>	<b>5</b>
<b>2.0 PLANNING AND DESIGN CONSIDERATIONS .....</b>	<b>5</b>
2.1 RESOURCE IDENTIFICATION .....	6
2.2 “WALK-THROUGH” MECHANICS .....	7
2.2.1 <i>Use of Flagging and Signs</i> .....	7
2.2.2 <i>Identification and Use of Existing Roads</i> .....	8
2.3 CONSTRUCTION SEQUENCING .....	8
<b>3.0 STANDARDS FOR CONSTRUCTION .....</b>	<b>9</b>
3.1 ROAD CONSTRUCTION .....	9
3.2 STREAM OR WETLAND CROSSINGS .....	10
3.2.1 <i>Types of Crossings Used</i> .....	10
3.3 CONSTRUCTION IN WETLANDS .....	11
<b>4.0 INSTALLATION OF CROSSINGS .....</b>	<b>11</b>
4.1 BRIDGES.....	11
4.2 CULVERTS.....	12
4.3 MATS (CRANE OR SWAMP MATS).....	13
4.4 CORDUROY .....	15
<b>5.0 SURFACE WATER DIVERSION STRUCTURES (WATER BARS).....</b>	<b>15</b>
<b>6.0 SEDIMENT BARRIERS (STRUCTURAL MEASURES) .....</b>	<b>17</b>
6.1 INTRODUCTION .....	17
6.2 SILT FENCE .....	18
6.3 HAY BALES.....	20
6.3.1 <i>Problems With Straw or Hay Bale Barriers</i> .....	22
6.4 EROSION CONTROL MIX BERMS .....	22
6.5 TEMPORARY SEDIMENT TRAPS .....	23
6.6 TEMPORARY SEDIMENT BASINS.....	24
<b>7.0 NONSTRUCTURAL EROSION CONTROL MEASURES .....</b>	<b>24</b>
7.1 NONSTRUCTURAL MEASURES DEFINED .....	24
7.2 IMPORTANCE OF NONSTRUCTURAL MEASURES .....	24
7.3 PLACEMENT OF NONSTRUCTURAL MEASURES .....	25
7.3.1 <i>Temporary Measures</i> .....	25
7.3.2 <i>Permanent Measures</i> .....	26
<b>8.0 WINTER CONSTRUCTION CONSIDERATIONS.....</b>	<b>26</b>
<b>9.0 SITE RESTORATION STANDARDS .....</b>	<b>30</b>
9.1 PROCEDURE .....	30
9.2 METHODS FOR RESTORATION .....	30

## LIST OF TABLES

TABLE 1 RECOMMENDED WIDTHS FOR FILTER STRIPS BETWEEN DISTURBED AREAS AND WATER RESOURCES .....	9
--	---

TABLE 2 LOG BRIDGE STRINGER REQUIREMENTS .....	11
TABLE 3 CULVERT SIZE - LENGTH OF ROCK PROTECTION.....	13
TABLE 4 RECOMMENDED DISTANCES BETWEEN WATER DIVERSION STRUCTURES.....	16
TABLE 5 TEMPORARY SEEDING RATES AND DATES.....	25
TABLE 6 NONSTRUCTURAL EROSION CONTROL MEASURES (SEASONAL DIFFERENCES IN CONSTRUCTION BMP REQUIREMENTS).....	28

## LIST OF APPENDICES

- A. DEFINITION OF TERMS
- B. CONSTRUCTION MATERIALS SOURCE LIST
- C. OTHER RECOMMENDED REFERENCE MANUALS
- D. CONSTRUCTION TECHNIQUE ILLUSTRATIONS
- E. EROSION AND SEDIMENTATION CONTROL LAW
- F. MAINE SLASH LAW
- G. CULVERT SIZES FOR STREAM CROSSINGS (3X RULE)

**This manual is the property of Central Maine Power Company and can be copied and distributed only upon the express permission of Central Maine Power Company.**

# **CENTRAL MAINE POWER COMPANY**

## **Environmental Guidelines for Construction and Maintenance Activities on Transmission Line and Substation Projects**

### **1.0 INTRODUCTION**

These guidelines contain standards and methods used to protect soil and water resources during construction, reconstruction, and maintenance of transmission lines and substations. They are based on practical methods developed for construction in utility corridors and their use is enforced by both State of Maine and Federal regulatory agencies. The construction practices described in this manual are typically required by the regulatory agencies for all projects. These practices are commonly referred to as Best Management Practices (BMPs). Illustrations have been provided as part of this manual (Appendix D) which demonstrate both the proper and improper techniques used for the more common construction activities.

All contracts for work performed on Central Maine Power Company (CMP) transmission line rights-of-way and substation sites will include these specific guidelines to ensure the project is constructed in an environmentally conscious manner. CMP personnel or their designated representatives will ensure that the guidelines are followed by inspecting all work and prescribing corrective steps to be taken where necessary. While this manual takes into consideration legal requirements, project personnel are still responsible for compliance with all federal, state, and local requirements.

This guide uses a number of scientific and technical terms. Definitions of these terms are provided in Appendix A.

### **2.0 PLANNING AND DESIGN CONSIDERATIONS**

Planning is an important practice that will reduce the risk of erosion on a construction site, saving both time and money for Central Maine Power Company and its contractors. An erosion control plan should be prepared during project planning and design phases. It will likely be required for any Maine Department of Environmental Protection and/or local permits.

The erosion control plan should consist of:

- A narrative.
- A map.
- Plan details.

The narrative should describe the proposed project, existing site conditions, adjacent land uses, and any natural resources or properties that might be affected by the project. Other important details to include are descriptions of critical areas, proposed construction start and end dates, construction sequence, and brief descriptions of erosion and sedimentation control measures,

inspections and maintenance programs, and other clearing or construction that has taken place on the site in the last five years.

The map should include pre-development site contours at a scale to identify runoff patterns (minimum 5-foot contour interval), final contours, limits of clearing and grading, existing buffers, critical areas, natural resources, erosion control measures, and other clearing or construction that has taken place on the site in the last five years.

The plan details should include drawing of the erosion control structures and measures, design criteria and calculations, seeding specifications, and inspection and maintenance notes.

Key considerations include resource identification, familiarizing all parties with the construction site and limitations, and construction sequence.

## **2.1 Resource Identification**

Sensitive natural areas which will receive priority treatment include:

- Streams and rivers.
- Great ponds.
- Wetlands.
- Steep slopes.
- Unstable soil conditions.

Sensitive natural areas which may receive priority treatment, depending upon the specifics of the project, include:

- Stream, river, pond, and wetland buffers.
- Significant wildlife habitats.
- Habitat for rare species.
- Historic and prehistoric sites.

During the planning phase, all sensitive natural areas that require priority treatment will be identified. The method of avoiding or crossing the sensitive natural areas to minimize impacts will be identified and incorporated into the project plans. Project plans should be designed and drawn to provide contractors and inspectors with a comprehensive reference guide that include, but is not limited to, locations of sensitive natural areas, access, and abutter and landowner issues. If modifications to the plans need to be made in the field, a designated person shall make necessary changes and shall notify all necessary personnel promptly. Copies of these plans should be provided and explained to equipment operators to assure that construction practices meet the intent of avoiding or minimizing impacts to the identified sensitive natural areas. In addition to the plans, the proposed access ways and water/wetland crossing locations, as well as other environmentally sensitive areas where activities will be restricted or prohibited, will be flagged and/or have signs posted.

Prior to crossings or construction in or near any sensitive natural areas, a “walk-through” will be conducted. Attendees at the walk-through will include: 1) the contractor, 2) CMP and/or any designated representative, and may include 3) any assigned Third Party Inspector. The purpose of the walk-through is to establish the following objectives, **prior to any clearing or construction work**:

- Identify available or alternate points of access to the project site.
- Identify sensitive natural areas.
- Identify future “No-Access” areas.
- Review color designation for all flagging used.
- Establish the Communication Chain of Command (Contact Point).
- Identify and flag access/construction roads within the ROW and/or project area.
- Establish methods of access over water resource areas (mats, timber corduroy, frozen ground, tracked equipment).

In order to minimize impacts to sensitive natural areas, the above objectives will continually be evaluated throughout the construction process. Project superintendents, foremen, and inspectors should also monitor weather conditions and reports on an on-going basis. Knowledge of changing or anticipated wet weather will allow time to address erosion control needs. In this way, CMP and its contractors will be prepared to respond to changing environmental conditions (e.g., unusually wet or dry weather) and other unknowns that are inherent in the construction and maintenance of transmission lines.

## 2.2 “Walk-Through” Mechanics

### 2.2.1 Use of Flagging and Signs

Flagging will be conducted at the time of the walk-through in order to visually identify select features or construction methods to be used. Wetlands may be flagged earlier as part of project permitting. Signs may also be installed following the walk-through to direct construction to approved access routes and away from “no access” areas. The CMP flagging color-code is as follows:

- **Glow-pink** with the printed words “Wetland Delineation”, “Wetland Boundary” or “Wetlands”. This flagging denotes the edge of wetlands.
- **Red** with or without the printed words – “Do Not Cross”. This flagging denotes a No-Access area where no equipment is allowed.
- **Yellow** – no printed words. This flagging denotes the location of an environmental measure such as a waterbar, hay bale barrier, or silt fence.
- **Blue** – no printed words. This flagging denotes approved travel ways. This is typically flagged on each side of the access-way to denote the designated travel lane for all access.
- **Glow-pink with black stripes** or otherwise printed with the words Buffer or Wetland Buffer. This denotes a setback from a water resource and should be treated the same as No-Access area.

### ***2.2.2 Identification and Use of Existing Roads***

Available logging, farm, or access roads, as well as other existing rights-of-way, will be utilized for access to and from transmission line rights-of-way with permission of the respective landowners. In order to minimize ground disturbance, existing roads within the right-of-way and wetland/stream crossing areas will be used whenever possible for travel during construction, unless a better route is agreed upon during the walk-through. The movement of equipment and materials within the transmission line right-of-way will be confined as much as possible to a single road or travel path.

For example, it may be better to construct new access roads in order to: (1) minimize the span of a wetland or stream crossing, or (2) avoid the more environmentally sensitive or “wetter” portions of a wetland or stream crossing.

In all cases, CMP and its contractors will attempt to avoid and minimize impacts to sensitive natural areas. As a result of this procedure, wetland and stream crossings, steep slopes, unstable soils, and other sensitive natural areas will be avoided and adverse impacts minimized whenever practicable.

### **2.3 Construction Sequencing**

Although a “Project Plan” may be specific in identifying the *locations* of water resource areas (wetlands, streams, etc.), and the *methods* of access over water resource areas (crane mats, frozen ground, etc.) it should not dictate *when* construction activities should occur. It would be impractical to include day to day activities in the “Project Plan” such as, ‘pole X will be installed on Y date’. However, including environmental considerations in the daily and weekly project planning is very important. Factors such as the project schedule and weather often determine where and when construction activities occur; environmental impacts should also be considered. Below are some guidelines:

- Work closely with the individual(s) in charge of environmental compliance to plan project activities.
- Construction activities that cause soil disturbance should not occur during or just prior to forecast heavy rain events.
- Coordinate access planning with all of the contractors on the project. Often temporary access roads are used by several different contractors and the construction and use of temporary access roads can cause significant soil disturbance. Minimize equipment and vehicle travel on temporary access ways.
- Stabilize/restore disturbed areas as soon as possible, preferably while equipment is on site. Additional trips with equipment can create more soil disturbance which will need to be stabilized. Often a site can and should be stabilized within hours of when the soil disturbance occurred.
- Use frozen conditions to your advantage. There may be instances where water resource areas can be crossed during frozen conditions in lieu of installing crane mats. Before using this technique consult with the project environmental inspector.

- Crane mats should be removed as soon as they are no longer needed and/or when conditions are favorable.

### 3.0 STANDARDS FOR CONSTRUCTION

#### 3.1 Road Construction

The following five standards apply to the construction and/or upgrade of all roads, skid trails, yarding areas, or work pads whether temporary or permanent.

1. Where construction will be located near water resources, such that material or soil may be washed into them, these disturbances will be set back from the edge of the water resource to maximize the amount of undisturbed filtering area between the disturbed area and the resource. These “filter strips” will consist of an area of undisturbed vegetation between the edge of disturbed area and/or silt fence/hay bale barriers placed to intercept any sediment load in runoff water before it can enter the resource area. In order to maintain the integrity and effectiveness of filter strips, sediment barriers should be installed very early in the construction sequence, and they need to be monitored to make sure they are functional. Effective filter strip widths may vary from only a few feet in relatively well drained flat areas to as much as several hundred feet in steeper areas with more impermeable soils. In steep terrain, additional erosion and sedimentation control measures will be installed at the low point where the work area drains into the filter strip when exposed soils exist and the flow path may result in channelization of runoff. The minimum width of the buffer strip shall be 25 feet or in accordance with local CEO or DEP regulations. The width of the filter strip shall be increased proportionately for slopes longer than 150 feet or for higher sediment concentrations. **Table 1** below provides the recommended widths for the filter strips according to the slope of land between the edge of the resource and any exposed soil.

<b>Table 1</b> <b>Recommended Widths For Filter Strips Between Disturbed Areas</b> <b>And Water Resources</b>	
Slope of Land Between Disturbance and the Resource (Percent)	Width of Filter Strip* (Feet)
0	25
10	45
20	65
30	85
40	105
50	125
60	145
70	165
*Measured along surface of the ground	

2. Wherever possible, construction equipment will either avoid steep slopes or proceed across the slope in a safe manner to avoid excessive disturbance of vegetation and soils. Equipment will not travel straight up or down any slopes with a grade steeper than 10 percent, except where necessary due to safety concerns and/or terrain constraints.
3. Where access roads or construction areas are to be built across the slope, the area will be properly sloped, slanting away from the cut bank to the outside edge of the roadbed in order to facilitate road surface drainage.
4. Slopes of cut-and-fill banks will be no steeper than 1 horizontal to 1 vertical. If located within 100 feet of water resources, the slopes will be no steeper than 2 horizontal to 1 vertical.
5. Rivers, streams, and wetland areas will be crossed, where necessary, at right angles to the channel and/or at points of minimum impact. To insure that natural drainage patterns will not be altered or restricted as a result of construction activities, crossings will be designed and constructed according to specific standards outlined below.

### **3.2 Stream or Wetland Crossings**

The following standards apply to all unavoidable stream, drainage way, or wetland crossings encountered while accessing the project site or on the project site itself.

#### ***3.2.1 Types of Crossings Used***

The type of crossing used for access is dependent on: the purpose and use of the crossing, the nature of the resource being crossed, ground conditions present at the time of construction, and construction materials available. Some planning guidance is provided below. The appropriate means and location of the crossing will be determined at the time of the formal walk-through. It is important to consult with the project environmental inspector prior to installing any crossing.

- Permanent culverts and bridges will be used only where long-term, continued, and frequent access is required (such as substation access roads).
- Temporary crossings will be used at all other locations. Temporary bridges, culverts, or crane mats must be used to cross any streams, drainage ways, or wetland swales that contain: (1) flowing water, (2) standing water, (3) saturated soils, or (4) organic/mucky soils.
- The use of corduroy as crossing material will be limited to wetlands which are not anticipated to have flowing or standing water during the construction period.
- In certain cases, no crossing material will be required if the stream bottom or drainage way is dry and contains a gravel or solid rock bottom (a “ford”). Fords can only be used if they will cause no unreasonable sedimentation of the stream and no unreasonable alteration of the stream banks and bottom.
- All crossings should include water bars or broad based dips or turn outs on the access, appropriately spaced on each side of the crossing, to promote filter-strip treatment of runoff. Consult Table 4 on page 12 of this document for specific water diversion structure spacing standards.
- All temporary crossings must be stabilized within seven (7) days of its removal, unless specified otherwise.



### 3.3 Construction in Wetlands

Where structures are to be placed in wetlands, topsoil must be excavated first, and stockpiled separate from subsoil. Be sure that stockpile soils are placed in such a manner that they are readily replaced into the excavated area. Soils shall be replaced into the excavated area in the opposite order they were removed. Excavation and pole placement in wetland areas should be completed within the same day. After pole installation, topsoil must be restored to the original surface grade, except where mounding around a structure is necessary for structure stability.

## 4.0 INSTALLATION OF CROSSINGS

### 4.1 Bridges

Bridges are a preferred method for temporary access waterway crossings. Normally, bridge construction causes the least disturbance to the waterway bed and banks when compared to the other waterway crossing methods. Most bridges can be quickly removed and reused without significantly affecting the stream or its banks and without interfering with fish migration.

#### Materials

Access bridge construction typically entails the use of log stringers as construction materials.

#### Sizing

Table 2 below illustrates the log sizing requirements depending on the span and anticipated loads.

<b>Table 2</b>		
<b>Log Bridge Stringer Requirements</b>		
Span	Minimum Log Diameter*	
	(80,000 lb. Load)	(40,000 lb. Load)
8 ft.	16 in.	12 in.
12 ft.	18 in.	14 in.
16 ft.	20 in.	16 in.

Wheel guards: 10" diameter  
- Size of deck planks: 4" x 12" x 12'  
\* Assume 6 stringers at 24" centers

#### Positioning

The following is guidance for the positioning and installation for all permanent and temporary bridges:

- Access roads will cross streams at right angles to the channel at a location with firm banks and level approaches whenever possible.
- Bridge piers and abutments will be aligned parallel to the stream flow so that the original direction of stream flow is not altered.
- Piers and abutments will be imbedded in good foundation material. The grade of the bridge should coincide with that of the road wherever practicable.

For additional specifications on bridge construction, refer to section F-2 of the Maine Erosion and Sediment Control BMPs (see full citation in Appendix C).

## 4.2 Culverts

### Materials

Permanent culverts will be either corrugated metal or plastic pipe. Temporary culverts will be corrugated metal, plastic pipe, or lumber ties. Chemically-treated wood will be not used.

### Sizing

Permanent culverts will be sized to have a diameter of at least 3 times the cross-sectional area of the stream channel or will be designed to accommodate 25-year frequency flows. Multiple culverts may be used in place of one large culvert if they have the equivalent capacity of a larger one. A culvert sizing criteria table (3x Rule) produced by the MDEP can be found in Appendix G. However, it is recommended that an engineer be consulted when installing any permanent culvert.

Temporary culverts will also be sized to provide an opening at least 3 times the cross-sectional area of the stream channel and sized to accommodate a 25-year frequency storm flow. The stream channel cross-section will be determined at highest flows or will be approximated during periods of lower flows using the apparent natural high water marks remaining on the stream banks. For small intermittent streams, drainage ways or wetland crossings, the minimum sized culvert that may be used is 18 inches. Multiple culverts may be used in place of one larger culvert if they have the equivalent capacity of a larger one.

### Positioning

The following is guidance for the positioning of all permanent and temporary culverts:

- Culverts should be placed to allow for the crossing to take place at right angles to the channel to assure that natural drainage patterns will not be altered.
- Culverts should be placed at the point of narrowest crossing and where firm banks and level approach slopes are available. Slopes should be no greater than 1.5 to 1.

### Installation

The following is guidance for the installation of all permanent and temporary culverts:

- Culverts should be of sufficient length to allow both ends to extend at least one foot beyond the toe of any fill used to cover the culvert.
- Inlet and outlet armoring shall extend at least one pipe diameter beyond the upstream and downstream end of the culvert. See Table 3 below for outlet protection in erodible areas.
- Culverts should be bedded on firm ground. Supplemental use of geotextile with gravel can be used to create this firm base. Permanent culvert installation should include firm compaction of the foundation and the fill around the sides of the culvert. Compaction should be done in no more than 8-inch lifts.

- Both the inlet and outlet ends of the culverts will be set at or slightly below the natural stream bottom to allow passage of fish and other aquatic life at all levels of flow. At no point should either end of an installed culvert be positioned in the air out of the water.
- Multiple culverts must be offset in order to concentrate low flows into the culvert within the natural channel.
- When working in and around a perennial stream, temporary stream diversion may be necessary to avoid creating turbidity in the stream water. This type of work requires a permit from Maine DEP, and must be coordinated with the project environmental inspector.
- Fill used to bury the culvert will be compacted at least half-way up the side of the culvert for its full length in insure that flowing water will not undermine the culvert.
- Culverts will be covered with fill to a depth of at least one foot or one and a half times the culvert diameter, whichever is greater.
- Road fill at the upstream (headwall) and downstream (out-fall) ends of culverts will be armored with either rock rip rap or logs to protect the road fill from being eroded by the action of water or road traffic. This material will be installed up to the level of anticipated high water.
- In areas where the streambed appears highly erodible, the streambed at the outlet end of the culvert will be lined with riprap to prevent erosion and potential stream bed scour. Table 3 below indicates the distances away from the culvert to install such riprap.

<b>Table 3</b>	
<b>Culvert Size - Length of Rock Protection</b>	
Culvert Diameter (Inches)	Length of Rock Protection From Culvert (Feet)
12 – 20	7
21 – 24	9
30	11
36	13
42 – 48	18
54 – 60	24
66 – 78	32

### Removal

Temporary culverts will be removed once their use is no longer necessary. The fill material can be redistributed and spread out on the nearby uplands at a distance sufficient to prevent its reentry into the resource. Silt fence/hay bales, seeding, and mulching may be necessary to stabilize this material. The banks and bottoms of the stream, drainage way, or wetland should be restored to original conditions. Exposed soils on the banks and within 100 feet of the crossing should be stabilized using seed and mulch. Some banks and steep slopes adjacent to streams may require stabilization with curlex or jute matting in combination with seed and mulch.

### **4.3 Mats (Crane or Swamp Mats)**

CMP construction projects require that adequate mats are present at the project site prior to construction. A readily accessible source of mats should also be available in case construction conditions change and necessitate the need for more mats.

## Materials

A number of different sized and constructed crane mats are typically available. CMP requires that the appropriate mats be used for the appropriate crossing. For example:

- Longer mats should be used for the longer crossing spans. This practice avoids the need to install additional mats within the crossing area in order to support the “span” mats.
- Mats should be in good condition to allow for their “clean” installation. Having mats in good condition prevents them from being dragged in versus them being carried in due to broken hitching cables, breaking apart on the job site, or becoming imbedded in mud due to their inability to support the required weight.
- Mats with partial/short timbers joined end to end should generally not be used to cross stream channels.

## Installation

- Whenever possible, mats should be carried and not dragged. Dragging mats creates more soil disturbance which requires additional erosion control or final restoration work.
- At the crossing location, the ends of the crane mats should extend at least two feet onto firm banks or several feet into the upland edge of a wetland to assure a dry, firm approach onto the mats.
- At crossings which contain open or flowing water, the mats should be supported within the span using cross mats as abutments in order to prevent the impoundment of water or having water flow over the mats.
- At “dry” crossings where no water is present or anticipated during project construction, the mats may be placed directly onto the sensitive natural area in order to prevent excessive rutting, provided stream banks and bottoms are not altered.

## Maintenance

Matted crossings should be continually monitored to assure their correct functioning. Mats which become covered with dirt should be kept clean and the material removed must be disposed of in an upland location. The material must not be scraped and shoveled into the water resource. Mats which become imbedded must be reset or layered to prevent mud from covering them or water passing over them.

## Removal

Mats should not be removed until their use is absolutely no longer necessary. Specifically, all final restoration work should be completed prior to the mats being removed from the crossings. The planned removal of mats should be coordinated with CMP (or designated representative), the project environmental inspector, and any Third Party Inspector. As temporary structures, they should be removed within one year from the date of installation. All areas disturbed during ford removal shall be stabilized with seed and mulch.

## 4.4 Corduroy

### Materials

Corduroy material will consist of de-limbed trees or logs. The logs must have a diameter greater than three inches at the small end and lengths greater than 18 feet. Shorter length material may be used only as described in the Installation section below.

### Positioning

Corduroy should be placed perpendicular to the direction of travel. Corduroy should be placed at the point of narrowest crossing and where firm banks and level approach slopes are available.

### Installation

The corduroy should be placed with the longer length pieces laid down first. The bed of corduroy should not only be placed within the low portions of the crossing but also for at least three feet up the sides of any upland side slopes in order to prevent rutting and sedimentation from the approaches to the crossing.

Once a thick base of corduroy has been laid, pieces shorter than 18 feet can be used to fill gaps and raise the elevation of the corduroy to provide for a more stable crossing.

### Removal

Removal is the reverse of installation. Once the corduroy has been removed from the crossing, it may be moved off the right-of-way, burned, or chipped. The material may also be spread and distributed on the ROW over the nearby upland if in accordance with the Maine Slash Law (see Appendix E) and approved by a CMP representative. The banks of streams and drainage ways must be graded back to original conditions. Exposed soils on the banks and within 100 feet of the crossing must be stabilized using seed and mulch. Banks of drainage ways that are expected to receive high flows should be stabilized with seed and curlex or jute matting.

## 5.0 SURFACE WATER DIVERSION STRUCTURES (WATER BARS)

A number of above-ground structures or techniques are available to divert water out of travel ways and work areas in order to prevent subsequent runoff and erosion. The terminology and definitions for these techniques (i.e., broad-based dips, water bars, skid humps, water turnouts, and cross-drainage box culvert) vary, but the purpose of all is to redirect water moving down a slope into adjacent vegetated areas (filter strips). Any activities that involve land grading have the potential to cause sedimentation. Their use and installation needs to be carefully planned. Planning for these techniques must include timing, use of natural buffers (filter strips), mulching, and temporary and permanent seeding. Minimizing the area of soil exposed at one time is a key component of ensuring that surface water diversion structures function effectively. General standards for their construction are as follows.

### Materials

Most of these structures are constructed by excavating or moving and shaping earth from within the access way or work area. The cross-drainage culvert structure typically uses logs or timber to form a box-like structure to catch water from travel ways or side ditches in order to direct it across the travel way and away from disturbed areas.

### Positioning

These structures should be installed immediately above and along steep pitches in the road and below seepage areas on natural or cut banks; be sloped away from the travel surface and be sited to take advantage of existing vegetation for filtering. In some areas of exposed soils, the right-of-way might be sloped such that runoff traverses the disturbed area. In these areas, temporary water diversions should be deployed to divert the upgradient runoff away from the disturbed work area and towards a stable drainageway. The interval for installing these diversion structures depends on the slope of the road, as well as the nature of the road surface, soils, and wetness. Generally speaking, steeper slopes require shorter distances between diversion structures. The following table contains recommended distances between installed structures depending on slope.

Slope (Percent)	Spacing (Feet)
2	250
5	135
10	80
15	60
20	45
30	35

All of these structures should be sized in anticipation of greater flows resulting from snow melt, spring runoff, and storm rains.

### Installation

These structures should be installed at 30-degrees angled down grade. The shape of the backside portion of the structure should have a reverse slope of about 3 percent. Use of a pop-level is recommended to ensure that drainage is away from the road. Structures should be constructed with rounded (not vertical) mounds and dips to allow for firm compaction and to allow re-vegetation.

In the case of the cross-drainage culvert, the minimum width of the open face of the culvert should be 18 inches. The travel surface should consist of at least 12 inches of gravel or soil over the culvert. The slope of the culvert should be a drop of at least 5 inches in every 10 feet of length to ensure proper drainage.

The inlet end of all structures should extend beyond the edge of the access road so that it fully intercepts water flows that may flow onto the access road. The outlet end of the structure should extend out enough to prevent water from flowing around and re-entering the road or work area.

The discharge ends of any of these diversion structures should outlet into a vegetated filter strip. Where heavy flows are encountered or anticipated, the outlet end of the structures should incorporate an apron of rock, gravel, or brush to reduce water velocities. If construction will

extend into fall and winter months, be sure to upgrade to meet winter standards all erosion control measures (e.g., increase amount of mulch, etc.), to protect the site from spring runoff.

Where the structure is within 100 feet of a stream or wetland, the incorporation of a small, excavated settling basin or ditch turnout to reduce the velocity of flows and the continued movement of sediment downslope should be considered. In addition, some type of sediment barrier (silt fencing or staked hay bales) will be installed at the outlet of the diversion structure, where vegetated filter strips are narrow or sparsely vegetated, in order to prevent sediment from eroding into water resources.

### Maintenance

Due to repeated travel over these structures, maintenance is critical to their effective functioning. As the structure becomes flattened or rutted, it needs to be re-excavated or graded to ensure the interception and redirection of water runoff. The ends of any cross-drainage culverts should be maintained by clearing away any potential blockages.

### Removal

After the completion of the construction project, removal of these structures is not a requirement, with the exception of the cross-drainage culvert. The structures can be left in place provided they have been suitably stabilized with seed and mulch. Any hay bale barriers or silt fence at the outlet end should be removed when the site has a healthy vegetative cover.

## **6.0 SEDIMENT BARRIERS (STRUCTURAL MEASURES)**

### **6.1 Introduction**

The use of properly installed erosion and sediment control barriers is a fundamental and critical component for preventing erosion at CMP construction projects. Erosion control barriers include silt fence, hay bales, and/or erosion control mix berms. In some cases, these barriers may be deemed unnecessary by CMP, its representatives, or a Third Party Inspector due to factors including slope and filter strip width within project boundaries. A typical CMP construction project will use a combination of barriers to effectively control erosion near water resources. Installation and diligent maintenance of these barriers serves the following purposes:

- Assures the environmental integrity of those upland and water resource areas not designated or permitted for disturbance. Specifically, it maintains the onsite vegetative community and water quality of the surface water within the watershed.
- Assures compliance with all applicable federal, state, and local environmental and land use regulations or permit conditions.

Generally, silt fence is the preferred barrier because: it traps a much higher percentage of suspended sediments than hay bales; it can be easier to install, obtain, and transport; and is less costly. In addition, the structural longevity of silt fence is 60 days or longer unlike straw or hay bales' longevity which is 60 days or less.

The standards and procedures outlined in this section of the manual are meant to address a majority of the situations encountered during transmission line and substation construction activities. For additional information on sediment and erosion control methods and techniques, or to address a particularly problematic situation, this manual should be used in conjunction with and supplemented by the Maine Erosion and Sediment Control BMPs. For other recommended references, see Appendix C.

## 6.2 Silt Fence

### Materials

Silt fence is provided by a number of manufacturers and is generally a synthetic fabric pre-attached to wooden staking. The fabric should be pervious to water allowing a flow through rate of 0.3 gallon per square foot per minute. The fabric should contain stabilizers and ultraviolet ray inhibitors to allow it to sustain exposure of a minimum of 6 months. The height of the filter fabric should not exceed 4 feet in height.

### Placement

Silt fence is to be utilized at the edge of any planned work area or area which will cause the disturbance of soil. It will be installed to intercept any sheet flow of water and detain sediment from entering water resources or leaving the project site. It should be installed prior to starting work. Given the expansiveness of CMP transmission line projects in particular, the amount of silt fence placement must be selective; however, it should still be used in amounts sufficient to meet potential changing conditions in a pro-active manner. After the primary stabilization measures (temporary and permanent) have been implemented, silt fence use is encouraged in the following selected locations, as appropriate:

- Around all substation project sites.
- Along all access roads or work areas that are within 100 feet of water resources.
- Along all access roads or work areas in upland settings that encounter seepage moving across slope.
- Around all stockpiled soils.

In general, the placement of silt fence is appropriate when:

- Serving a drainage area of no more than .25 acre per 100 feet of silt fence length.
- The maximum slope length behind the fence is 100 feet or less.
- The maximum gradient behind the fence is 50% or 2:1 horizontal/vertical.
- Where the filter strip is not of an adequate width (see Table 1).

### Installation

The following installation guidelines are the minimum which should be implemented; however, appropriate changes to silt fence installation should be made as conditions change during the construction operation.

Silt fence will be placed an adequate distance (6-10 feet) beyond the toe of the slope (if there is sufficient room) to allow for sediment accumulation between the disturbed area and the down-



gradient water resources. If there is not sufficient room to place the silt fence an adequate distance beyond the toe of the slope, CMP, a representative of CMP, or the Third Party Inspector should be consulted. The barrier should be installed along the contour, within reason. The goal is to slow and pool the sediment-laden runoff to allow fine sediments to settle-out before the runoff enters the water resource. The ends of the barrier should be up-turned to maintain the pool volume.

A trench shall be excavated approximately 6 inches wide and 6 inches deep on the up-slope side of the silt fence alignment. The lower edge of the silt fence fabric should be entrenched for a distance of at least 4 inches up-slope and then back-filled. Should frozen or rocky ground conditions prevent the effective or practical use of trenching, materials such as bark/wood chips, wood fiber mulch, or a soil erosion control mixture can be used. This material is to be mounded on top of at least 4 inches of filter fabric which would otherwise be trenched.

Silt fence should be installed in a continuous roll to avoid the need of a joint between different pieces of fence. If joints are necessary, filter fabric shall be “spliced” together at a support post, securely sealed, and with a minimum of 6 inches of overlap. Splicing rolls of silt fence entails twisting end posts together, creating a continuous section of silt fence.

Support posts should be placed on the down-slope side or the side closest to or facing the water resource. The posts should be placed 6 feet apart (a maximum of 10 feet may be acceptable in some locations) and driven securely into the ground, typically about one foot deep. Silt fence usually has posts pre-attached.

**Silt fence should not be installed in streams or drainage ways where concentrated water flow is present or concentrated flows are anticipated.**

#### Maintenance

Once a week, or after rainstorms producing at least ½ inch of rainfall, whichever is more frequent, the contractor is responsible for inspecting all temporary erosion and sediment control barriers. Such inspection is necessary to assure that the barriers are functioning properly as well as identifying new areas requiring installation. A maintenance log should be kept of all erosion control changes, improvements, and maintenance performed.

If any barriers are not functioning properly, they will be repaired or replaced. A sediment control barrier is not functioning if:

1. Water is flowing around the sides or under the barrier.
2. Soil has built up behind the barrier to the point more than half-way up the fence.
3. There is excessive sag in the fence.
4. There is evidence of sedimentation such as gully erosion, slumping of banks, or the discoloration of water outside of the perimeter silt fence.

Corrective measures include removing accumulated sediment from behind the barrier, restaking, extending the ends of the fence, or installing another fence further upslope.

### Removal

Installed silt fence will be removed once it is evident that the soils have become stabilized and the potential for erosion no longer exists. In most cases, the silt fence will not be removed until at least one growing season has past. Removal of silt fence should be coordinated with CMP or their designated representative.

Any ridges or mounds of soil or caught sediment remaining in place after the silt fence has been removed, must be leveled-off to conform to the existing grade. Any newly exposed soil that may erode must be seeded and mulched.

All removed silt fence must be properly disposed of off the project area.

## **6.3 Hay Bales**

### Placement

Like silt fence, hay bale barriers can be utilized at the edge of any planned work area or areas where soil disturbance has occurred or will occur. Barriers are installed to intercept sheet flow of water and detain sediment from entering water resources or leaving the project site. Given the expansiveness of CMP transmission line projects in particular, the amount of hay bale barrier placement must be selective, but still in amounts sufficient to meet potential changing conditions in a pro-active manner. Hay bale barriers will be used, as appropriate, in the following locations:

- Around all substation project sites.
- Along all access roads or work areas that are within 100 feet of a water resource area.
- Along all access roads or work areas in upland settings that encounter seepage moving across slope.
- Around all stockpiled soils.

In general, the placement of hay bales is appropriate when:

- Serving a drainage area of no more than .25 acre per 100 feet of barrier length.
- The maximum slope length behind the barrier is 100 feet or less.
- The maximum gradient behind the barrier of 50% or 2:1 horizontal/vertical.
- Where the filter strip is not of an adequate width (see Table 1).

### Installation

The following installation guidelines are the minimum which should be implemented; however, appropriate changes to hay bale installation should be made as conditions change during the construction operation.

The barrier will be placed an adequate distance (6-10 feet) beyond the toe of the slope (if there is sufficient room) to allow for sediment accumulation between the disturbed area and the down-gradient sensitive areas. If there is not sufficient room to place the hay bales an adequate distance beyond the toe of the slope, CMP, a representative of CMP, the project environmental inspector, or the Third Party Inspector should be consulted. Within reason, the barrier should be installed along the contour. The goal is to slow and pool the sediment-laden runoff to allow fine

sediments to settle-out before the runoff enters the water resource. The ends of the barrier should be up-turned to maintain the pool volume.

A shallow trench shall be excavated the width of the bale and to a minimum depth of 4 inches in which to bed the bale. The excavated soils are then used to seal the lower inside (up-slope) edge of the barrier. The bales should be set tightly together and entrenched with the baling string oriented on the sides (i.e., not touching the ground) in order to prevent deterioration of the string.

Every bale should be staked using 2 stakes per bale. The stakes should be driven in at angles such that it binds and forces abutting hay bales together.

Gaps between bales shall be packed with loose hay to prevent water from escaping between the bales.

Hay bales will not be placed in streams where flow is present or anticipated.

### Maintenance

Once a week, or after rainstorms producing at least ½ inch of rainfall, whichever is more frequent, the contractor is responsible for inspecting all temporary erosion and sediment control barriers. Such inspection is necessary to ensure the structures are functioning properly as well as identifying new areas requiring installation. A maintenance log should be kept of all erosion control changes, improvements, and maintenance performed.

If any barriers are not functioning properly, they must be repaired or replaced. A sediment barrier is not functioning if:

- Water is flowing around the sides or under the barrier.
- Soil has built up behind the barrier to the point more than half-way up the hay bale or where there is excessive lean to the barrier.
- There is evidence of sedimentation such as gully erosion, slumping of banks, or the discoloration of water outside of the hay bale barrier.

Corrective measures include removing accumulated sediment from behind the barrier, re-staking, extending the barrier at the ends, or installing another barrier further up-slope.

It is not recommended that straw or hay bales be used for periods greater than 60 days.

### Removal

Installed hay bales will be removed once it is evident that the soils have become stabilized and the potential for erosion no longer exists. In most cases, the hay bale barrier will not be removed until at least a healthy growth of vegetation is established on the disturbed site. Removal of hay bale barriers should be coordinated with CMP or their designated representative.

Any ridges, mounds of soil, or caught sediment remaining in place after the hay bales have been removed, must be leveled-off to conform to the existing grade. Any newly exposed soil that may erode must be seeded and mulched.

All removed hay bales must be properly disposed of, or broken up and used as mulch on the bare soils near the barrier.

### ***6.3.1 Problems With Straw or Hay Bale Barriers***

There are several situations where straw or hay bale barriers may be ineffective or cause problems:

1. When improperly placed and installed (such as staking the bales directly to the ground with no soil seal or entrenchment), hay bales allow undercutting and end flow.
2. When used in streams and drainage ways, high water velocities and volumes destroy or impair their effectiveness.
3. When bales are not inspected and maintained adequately.
4. When hay bale barriers are removed before up-slope areas have been permanently stabilized.
5. When hay bale barriers have not been removed after they have served their usefulness.

## **6.4 Erosion Control Mix Berms**

### Composition

Erosion control mix berms are made up of shredded bark, stump grindings, and composted bark. It may be made on a project site if adequate materials are available, however its composition needs to be a well-graded mix of different particle sizes. Wood chips, bark chips, ground construction debris and processed wood cannot make up the organic component of the mix. Be sure to consult with the project environmental inspector regarding the suitability of any erosion control mix material proposed for use.

### Installation

Erosion control mix berms are simply placed on the surface of the ground and do not require any soil disturbance. The berm should be located in a similar manner to other sediment control barriers along contour, downslope of disturbed soils. Also similar to other sediment barriers, they should not be placed in areas of concentrated runoff, below culvert outlets, around catch basins, or at the bottom of a large contributing subwatershed. At the toe of shallow slopes less than 20 feet long, at a minimum berms should be 12” high and a minimum of 2 feet wide at their base. For longer or steeper slopes, the berms should be wider to accommodate additional runoff. They are ideal for installation on frozen ground, on shallow to bedrock soils, outcrops of bedrock, and heavily rooted forested areas (i.e., those areas where other barriers are difficult to install).

Erosion control mix can also be placed in a synthetic “sock” to create a contained stable sediment barrier. This is especially useful in areas where trenching is not feasible, such as frozen ground, across pavement, or compacted gravel. When in a sock, erosion control mix can be staked in an area of concentrated flow (i.e., ditch or swale) as the netting prevents movement of the mulch mixture.

### Maintenance

As with other barriers, inspection should be performed after each rainfall or daily during prolonged periods of rain. Accumulations of sediment should be removed when they reach half the height of the barrier, and the berms can be reshaped and new material can be added as needed.

### Removal

In most cases, erosion control mix berms do not need to be removed. They will continue to function as they decompose, become part of the soil on the site and will naturally revegetate. If synthetic socks are used, the erosion control mix can be emptied from the sock and the socks can be disposed of offsite.

## **6.5 Temporary Sediment Traps**

Temporary sediment traps function to slow or temporarily detain runoff and allow sediment to settle out of the water column prior to runoff leaving a project site. Sediment traps generally consist of natural or manmade depressions. Sediment traps are not designed for high volume or high velocity flows.

### Installation

Areas draining to sediment traps should be relatively small. Sediment traps are routinely installed at the discharge end of a water bar or upgradient water diversion to treat runoff. Natural depressions can be used or modified, and small basins can be excavated. Structural erosion control devices can be installed along the downslope perimeter of natural or excavated sediment traps to increase filtration of any runoff that overtops the trap. Sediment traps should discharge to vegetated buffer areas.

Sediment traps may also be constructed using structural erosion controls such as hay bale corrals lined with geotextile fabric. Care should be taken to prevent existing vegetation or obstructions from tearing the fabric and allowing the runoff to escape the fabric untreated.

### Maintenance

When sediment has accumulated to 50% of the capacity of the trap it should be removed and placed in an upland area and stabilized in a manner to prevent its entry into protected natural resources. Similarly, non-functioning or damaged geotextile fabric must be removed, disposed of properly and replaced as needed.

### Removal

Temporary sediment traps shall be removed, and areas shall be regraded to original contours and stabilized with permanent non-structural controls until fully re-vegetated. All structural controls used to construct temporary sediment traps must be removed and disposed of properly.

## **6.6 Temporary Sediment Basins**

Permanent sediment basins, designed by a qualified engineer, can be used during construction for temporary storage of stormwater and settling of sediments. Sediment basins should be constructed and stabilized prior to the remainder of the site being disturbed. Flow patterns across the site should be directed towards the sediment basin for treatment.

Installation of the sediment basin shall be completed per the design on the engineer-stamped drawings. Following its use as a temporary sediment basin, all collected sediment must be removed and necessary repairs made to allow for the intended permanent function of the engineered design. Sediments removed from the basin must be placed in an upland area and stabilized in a manner to prevent its introduction into protected natural resources.

## **7.0 NONSTRUCTURAL EROSION CONTROL MEASURES**

### **7.1 Nonstructural Measures Defined**

Nonstructural measures are temporary or permanent methods used to cover exposed soil areas to prevent erosion from occurring. Their purpose is to cover whole areas of exposed soil to prevent initial erosion of soil from a construction site.

Examples of nonstructural measures include hay or straw mulch, erosion control mix, matting, or seeding.

### **7.2 Importance of Nonstructural Measures**

Nonstructural measures are important because they provide both temporary and permanent protective cover to exposed soils. Generally, they provide the first line of protection against erosion, and can be the most effective means of preventing erosion. This protection is important because exposed soils are easily eroded by wind or water. Some soils such as silts can easily be removed from a construction site by rainwater. The impact of individual raindrops on exposed soils can loosen soil particles, and these particles can then be carried off the work site by runoff and deposited into water resources including streams, rivers, wetlands, ponds, and lakes. Silt particles don't settle out of water easily, and water siltation can pollute surface waters and harm aquatic creatures such as insects and fish. For example, brook trout, one of Maine's premier game fish species, requires clear, high quality water in order to survive. Silty water can reduce spawning habitat, irritate fish gills, lower oxygen content in water, and make fish susceptible to diseases.

Dry soil conditions and high winds can also cause siltation. When small particle soils such as silts become dry, they have a baby powder-like texture and can easily be swept away by winds. Nonstructural measures help prevent wind erosion because they hold moisture next to the soil, keep the soil from drying out due to wind exposure, and prevent winds from carrying away dry soil particles. Keep in mind, however, that proper construction sequencing is invaluable (See Section 2.3).

### 7.3 Placement of Nonstructural Measures

Nonstructural measures should be used whenever there is a possibility that exposed soils on a construction site could wash into adjacent sensitive water resources. Temporary nonstructural measures such as hay or straw mulch should be spread on exposed soils within 100-feet of water resources within 48 hours of initial soil disturbance, or before any predicted storm event. There are two types of nonstructural measures: temporary and permanent. Temporary measures are typically used during construction, while permanent measures are usually applied after construction is complete (i.e., restoration). Provided below are general discussions and explanations of the common nonstructural measures that are used on CMP construction sites.

#### 7.3.1 Temporary Measures

- Hay or straw mulch (unanchored on slopes less than 8%, anchored on slopes greater than 8%) on exposed soil areas and soil stockpiles in the construction area.
- Temporary seeding covered by hay or straw mulch on soil stockpiles or areas of exposed soil next to sensitive resources that are not scheduled for final restoration for 30 days (this only applies between the dates of April 16 to October 31 of any given year). Temporary seeding is not required during the Winter Construction Season.
- Erosion control mix can be used as a stand-alone temporary mulch on slopes that are 2 horizontal to 1 vertical, or less, on frozen ground, in forested areas, or at the edge of gravel parking and areas under construction. It should be applied at a thickness of 4 to 6 inches.
- Rolled Erosion Control Products (RECP's) such as Curlex or Jute matting, can be used on areas of high wind exposure, steep slopes (steeper than 8% grade), unstable soils, and stream/river bank restoration areas. Matting is typically anchored (usually with large staples, as recommended by the manufacturer). Although this type of material is usually used during final restoration, it is considered a temporary measure because it generally deteriorates within two years.

Seed	Lb./Ac	Seeding Depth	Recommended Seeding Dates	Remarks
Winter Rye	112(2.0 bu)	1-1.5 in.	8/15-10/1	Good for fall seeding. Select a hardy species, such as Aroostook Rye.
Oats	80 (2.5 bu)	1-1.5 in.	4/1-7/1 8/15-9/15	Best for spring seeding. Early fall seeding will die when winter weather moves in, but mulch will provide protection.
Annual Ryegrass	40	.25 in.	4/1-7/1	Grows quickly but is of short duration. Use where appearance is important. With mulch, seeding may be done throughout growing season.
Sudangrass Perennial	40 (1.0 bu) 40 (2.0 bu)	.5-1 in. .25 in.	5/15-8/15 8/15-9/15	Good growth during hot summer periods. Good cover, longer lasting than Annual Ryegrass. Mulching will allow seeding throughout growing season.

Temporary mulch with or without dormant seeding			10/1-4/1	Refer to TEMPORARY MULCHING BMP and/or PERMANENT VEGETATION BMP.
---	--	--	----------	--

Proper application rates, location, and seasonal consideration are provided in Table 6 on page 23 of this manual.

### 7.3.2 Permanent Measures

#### Uplands

- Permanent grass and legume seeding covered by hay or straw mulch on all areas that have been restored to final grade (this seeding generally applies between the dates of April 16 to October 31 of any given year). This is required to establish permanent, perennial, vegetative cover on exposed soils. Permanent seeding is not required during the Winter Construction Season, although dormant seeding may be performed. (See Section 8.0 for details on winter construction.)
- Seeds covered by anchored (usually with large staples) Curlex or jute matting in areas of high wind exposure, on steep slopes (steeper than 8% grade), unstable soils, and stream/river bank restoration areas.
- The soil may need to be properly prepared before any seeds are placed on the ground. This preparation may include addition of fertilizer (only in designated upland areas not adjacent to, or near waterbodies or wetlands, if in doubt ask the environmental or construction inspector) in areas that have been tested, and are found to be deficient in plant nutrients.
- Erosion control mix can also be used as a permanent mulch to provide a buffer around disturbed areas. It can be left in place to decompose and naturalize. It will eventually support vegetation, which should be promoted. If vegetation is desired in the short-term, legumes and woody vegetation can be planted, which will create additional stability.

#### Wetlands

- Wetland areas are to be seeded only with resource agency approved wetland seed mixes. If it is decided that wetlands will not be seeded, disturbed wetland will be graded to original contours, mulched with straw, and allowed to revegetate naturally.

As with the Temporary Measures, refer to Table 6 on page 23 for proper application rates, locations, and seasonal considerations.

For permanent seeding mixtures, consult the approved plans/proposal for the project, the environmental inspector, or Appendix A of the Maine Erosion and Sediment Control BMPs.

## 8.0 WINTER CONSTRUCTION CONSIDERATIONS

If a project is actively being constructed between November 1 and April 15 of any given year, sediment and erosion control guidelines developed by the Maine Department of Environmental Protection for projects occurring during the winter months must be followed.



Proper construction sequencing (Section 2.3) can greatly minimize environmental impact during winter construction. When in doubt, contact the project construction manager or environmental inspector with any questions.

Table 6 on page 23 highlights some of the major differences between the winter construction guidelines and normal BMPs used during construction and for temporary stabilization. The table presents differences for temporary measures that should be used during construction, and permanent measures when construction is completely done.

**Table 6**  
**Nonstructural Erosion Control Measures (Seasonal Differences in Construction BMP Requirements)**

<b>Dates</b>	<b>General Construction April 16 through October 31 of every year</b>	<b>Winter Construction November 1 through April 15 of every year</b>
<b>Mulch on slopes less than 8%</b>	Within 100-feet of sensitive water resources apply hay and/or straw mulch at a minimum of 70 lbs./1000 square feet of exposed soil (about 2 bales). Must be done within 7 days of initial soil disturbance and before storm forecasted events, unless specified otherwise.	Within 100-feet of sensitive water resources apply and maintain properly anchored hay and/or straw mulch at a minimum of 150 lbs./1000 square feet of exposed soil (about 5 bales) at all times. (double the April 16 – October 31 rate)
<b>Mulch on slopes greater than 8%</b>	Hay or straw mulch can be applied without being anchored, though specific site conditions may require use of anchoring.	Apply mulch as specified above. Properly anchor with Curlex, jute matting, or similar mulch netting on upland slopes exceeding 8% and within 100 feet of streams if no construction activities are anticipated for 7 or more days.
<b>Area of exposed soils allowed at any one time</b>	No restriction on area exposed, but contractor must attempt to minimize amount of exposed soil at any one time, especially next to water resources.	Not more than one (1) acre of exposed (not mulched or otherwise devoid of vegetative cover) soil.
<b>Sediment barriers</b>	A single line of sediment barriers including silt fence, hay bales, or wood waste filter berms must be installed between water resources and disturbed soils.	If soil is frozen, wood waste filter berms <b>or</b> 2 lines of sediment barriers (including hay bales and silt fence) must be placed between water resources and disturbed soils.
<b>Temporary seeding in uplands</b>	If required, apply at the rate specified by the supplier, CMP Environmental Department, or Environmental Inspector. Cover with mulch.	Not required, but if temporary seeding is desired, it must be applied at a rate 3 times higher than the General Construction Season, and covered with mulch.
<b>Temporary seeding in wetlands</b>	Wetlands are not to be seeded unless done so with an agency-approved seed mix. Annual Rye Grass is not acceptable and shall not be used. Disturbed wetland areas will be mulched exclusively with straw.	Wetlands are not to be seeded unless done so with an agency approved seed mix. Annual Rye Grass is not acceptable and shall not be used. Disturbed wetland areas will be mulched exclusively with straw.
<b>Permanent seeding in uplands</b>	Site must be seeded at rate specified by the supplier and covered with hay or straw mulch. If needed, the site can be limed and fertilized.	Not required before April 16, but if dormant seeding is desired, the site should receive an adequate cover of loam, if necessary, be seeded at a rate 3 times higher than the General Construction Season, and covered with mulch at a minimum of 150 lbs./1000 square feet.
<b>Permanent seeding in wetlands</b>	Do not apply permanent seed mixes to wetland areas unless they are specially designated wetland seed mixes approved by a resource agency.	Do not apply permanent seed mixes to wetland areas unless they are specially designated wetland seed mixes approved by a resource agency.
<b>Temporary seedbed preparation</b>	Apply limestone and fertilizer (uplands only) according to soil test data. If soil test is not possible, 10-10-10 fertilizer may be applied at a rate of 600 lbs./acre and limestone at 3 tons/acre.	Not required, but seedbed can be prepared according to General Construction requirements.

<b>Dates</b>	<b>General Construction April 16 through October 31 of every year</b>	<b>Winter Construction November 1 through April 15 of every year</b>
<b>Permanent seedbed preparation</b>	Apply limestone and fertilizer (uplands only) according to soil test data. If soil test is not possible, 10-20-20 fertilizer may be applied at a rate of 800 lbs./acre and limestone at 3 tons/acre.	Not required before April 16, but if dormant seeding is desired, the seedbed can be prepared according to the General Construction requirements.
<b>Temporary slope stabilization</b>	Same as winter construction season, but mulch does not need to be anchored.	Anchored hay or straw mulch on slopes greater than 8% and drainage ways with greater than 3% slope as necessary. Wood waste mix can be used on slopes in place of anchored hay or straw mulch.
<b>Maintenance of erosion controls</b>	Same as winter construction guidelines.	All erosion controls should be inspected periodically to ensure proper function. If any evidence of erosion or sedimentation is evident, repairs should be made to existing controls or other methods should be used.
<b>Inspection and monitoring</b>	Monitoring should be performed as needed until a new, healthy vegetative cover is attained on the site. This applies to both temporary and permanent seeding.	Monitoring should be performed as needed to ensure proper stabilization and re-vegetation (both temporary and permanent). Starting in the spring following completion of the project, inspections should be performed until new, healthy vegetative cover is attained.

## **9.0 SITE RESTORATION STANDARDS**

Following completion of the construction work, the contractor will be responsible for conducting site restoration work. The following guidelines will apply to all activities, including temporary and permanent roads, stream/wetland crossings, staging and work areas, and substation sites.

### **9.1 Procedure**

At the completion of project construction in an area or at the end of the construction, CMP or their designated representative, the contractor, and any Third Party Inspector will review the project's restoration needs and prioritize the areas. This prioritization should consider time of year, ground conditions, re-vegetation probabilities, and equipment availability. A restoration "walk-through" is strongly recommended.

In many cases a site can and should be restored within hours of when the soil disturbance occurred. Often getting the equipment to a site that needs to be restored only creates more disturbed area to restore. It is important to "restore as you go" to reduce the equipment travel on temporary access roads. It can be particularly difficult to restore an area that was disturbed during winter construction activities in the spring or summer.

Likely areas of restoration include, but are not limited to:

- Around substation construction areas.
- Around pole and anchor pole placement.
- All wetland, stream, or brook crossings, particularly the approaches and any stream banks.
- Drainage ways or ditches.
- All temporary or permanent constructed roads, yarding, and staging areas.
- Cut banks.
- Steep slopes (over 8%).

### **9.2 Methods for Restoration**

There are several methods of restoration for different areas.

1. All soil that is excavated, mounded, or deposited during construction will be re-graded or removed from the site as directed by CMP. All re-grading and redistribution of soil will be done to match existing grade.
2. The banks and bottoms of brooks, streams, and rivers will be restored to natural conditions. In general, any material or structure used at temporary crossings will be removed, and the bank and bottoms restored to their original depth and contour.
3. On permanent access roads, stream culverts and bridges will be left intact and in good repair to remain available for maintenance operations and/or public access (woods roads, camp roads, etc.).
4. On those construction roads to be closed to future vehicle traffic (as determined by CMP), bridges, culverts, and other temporary crossing or water diversion structures will be removed and the banks and bottoms restored to original conditions.

5. Previously installed water bars may remain or new ones will be installed at locations designated by CMP or their designated representative. To prevent accelerated soil erosion, such water bars will be installed on all access and construction roads to be closed to vehicle traffic and on steep sections of permanent roads. Permanent water bars will be constructed to a sufficient height and width to divert the amount of water anticipated at each location as well as to provide some post-project permanence to the site. Water bars on long-term temporary access roads will be constructed in such a manner that they will remain effective and require minimal maintenance, and will be permanently seeded to ensure their long-term stability.
6. All areas severely rutted by construction equipment will be re-graded and permanently revegetated.
7. Upon completion of the project, all disturbed areas will be permanently revegetated or otherwise permanently stabilized. This includes the restoration of all areas disturbed by pole installation, temporary access roadways, permanent access roadways, substation construction, and resource crossings. Restoration is generally assumed to be a well-established vegetative cover. All cut and fill slopes must be revegetated, stabilized with riprap, or stabilized with erosion control mix, as appropriate to the slope conditions.
8. Liming, fertilizing, and seeding requirements for permanent re-vegetation will depend upon the soil type and drainage condition of the site. In the absence of soil tests, permanent seeding will generally be done in accordance with "Procedures for Permanent Seeding for Erosion Control" found in Table 6 on page 23.
9. The contractor will be responsible for the proper maintenance of all revegetated areas until the project has been completed and accepted. Where seed areas have become eroded or damaged by construction operations, the affected areas will be promptly re-graded, limed, fertilized, and re-seeded as originally required.
10. The contractor will perform all erosion control work to the complete satisfaction of Central Maine Power Company before the work is accepted. Central Maine Power Company will base acceptance of the erosion control and stabilization work on a final inspection.

**APPENDIX A**  
**DEFINITION OF TERMS**

## **APPENDIX A**

### **DEFINITION OF TERMS**

**Adjacent to a natural resource:** Within 75 feet of, or in a position to wash into, a water resource (river, stream, brook, pond, wetland, or tidal area).

**Annual seed mix:** Seed mixture largely made up of plants that only persist one growing season.

**Brook:** Essentially the same as a stream, a water course that has a defined channel, a gravel, sand, rock or clay base, and flows at least part of the year. It may be a dry channel part of the year.

**Corduroy:** Logs greater than 3 inches in diameter at the small end and at least 18 feet long that are placed perpendicular to travel direction, on approaches to and in wetlands for crossings. The purpose of the logs is to prevent rutting and preserve vegetation root integrity in and adjacent to wetland areas. May also be used on approaches to mats or bridge stream crossings.

**Crossing:** Any activity extending from one side to the opposite side of a sensitive natural resource whether under, through, or over that resource. Such activities include, but are not limited to, roads, fords, bridges, culverts, utility lines, water lines, sewer lines, and cables, as well as maintenance work on these crossings. Crossings should be done to minimize impact. For example, crossing at a right angle to the resource and finding the driest or narrowest spot is one method for minimizing impact.

**Cross-sectional area:** The cross-sectional area of a stream channel is determined by multiplying the stream channel width by the average stream channel depth. The stream channel width is the straight-line distance from the normal high water line on one side of the channel to the normal high water line on the opposite side of the channel. The average stream channel depth is the average of the vertical distances from a straight line between the normal high water marks of the stream channel to the bottom of the channel.

**Culvert:** A pipe or box structure of wood, metal, plastic, or concrete used to convey water.

**Erosion:** Movement of earthen material by water or wind.

**Erosion control blanket (matting):** Manufactured material made out of natural or synthetic fiber designed to control movement of earthen material when installed properly.

**Erosion control mix:** Erosion control mix consists primarily of organic materials such as shredded bark, wood chips, stump grindings, composted bark, or similar materials. Ground construction debris or reprocessed wood products are not acceptable for use in erosion control mix. It contains a well-graded mix of particle sizes and may contain rocks up to 4 inches in diameter. Properly manufactured mix will have organic matter content between 80 and 100 percent (dry weight), 100 percent of particles must pass a 6-inch screen, the organic portion needs to be fibrous and elongated, it may contain only small proportions of silts, clays, or fine sand, and its pH should be between 5.0 and 8.0. Its applications include erosion control berms and mulch.

**Erosion control plans:** Written guidelines specific to a project or activity, describing various techniques and methods to control erosion for specific construction activities.

**Fill:** Any earth, rock, gravel, sand, silt, clay, peat, or debris that is put into or upon, supplied to, or allowed to enter a water body or wetland. Material, other than structures, placed in or adjacent to a water body or wetland.

**Filter strip:** Undisturbed areas of ground consisting of natural vegetation and natural litter such as leaves, brush, and branches, located between a water resource and access road, skid road or trail, or other area of disturbed soil.

**Ford:** A permanent crossing of a stream utilizing an area of existing, non-erodible substrate of the stream, such as ledge or cobble, or by placing non-erodible material such as stone or geotextile on the stream bottom.

**Geotextile, Non-woven:** Synthetic material made of spun polypropylene fiber used to support wetland fill or stabilize soils.

**Geotextile, Woven:** Synthetic material of woven polypropylene used to stabilize soils and make sediment barriers (silt fence).

**Great pond:** An inland water body which in a natural state has a surface area in excess of 10 acres, and any inland water body which is artificially formed or increased which has a surface area in excess of 30 acres.

**Intermittent watercourse:** Water course that has water in it only part of the year. It is still considered a natural resource.

**Mats:** Pre-constructed, portable, timber platforms used to support equipment or travel in or over wetlands or water bodies.

**Mulch:** Temporary erosion control such as hay, bark, or some similar natural material utilized to stabilize disturbed soil.

**Perennial seed mix:** Seed mixture made up of seeds from plants that persist for several years.

**Perennial watercourse:** A river, stream, or brook depicted as a solid blue line on the most recent edition of a United States Geological Survey 7.5 minute series topographic map.

Typically has water in it year round.

**Permanent access road:** Project access road that is not restored after project construction completion. Permanent access roads should be designed and constructed so they are not an erosion problem.

**Permanent stabilization:** Establishment of a permanent vegetative cover on exposed soils where perennial vegetation is needed for long-term protection.

**Permanent vegetative cover:** Perennial seed stock, including but not limited to grasses and legumes that persist for more than several growing seasons.

**Protected Natural Resource:** Coastal sand dune system, coastal wetlands, significant wildlife habitat, fragile mountain areas, freshwater wetlands, community public water system primary protection areas, great ponds or rivers, streams, or brooks. (From the Maine Natural Resources Protection Act, 38 M.R.S.A. Section 480-B., revised 2007).

**Riprap:** Heavy, irregular-shaped rocks that are fit into place, usually without mortar, on a slope in order to stabilize and prevent soil erosion.

**Sediment barrier:** Staked hay bales, silt fence, or similar materials placed in a manner to intercept silt and sediment laden water runoff.

**Sedimentation:** Deposition of earthen material in a water body or wetland.

**Sensitive Natural Resource:** Area that deserves special attention because it is significant wildlife habitat, fisheries habitat, or has other natural resource values. These areas may require the use of minimum impact construction techniques such as use of mats, leaving vegetation intact for buffers, special timing of construction, or other specific techniques.

**Settling basin (sediment/catch basin):** Excavated pit placed to intercept water running off disturbed soils or dirt road bed. Usually used only where filter strip is inadequate to protect a stream, pond, or wetland from silt and sediment.



**Silt fence:** Woven geotextile sediment barrier. Proper installation requires placement on-contour and keying the fabric in at ground level.

**Steep slopes:** Slopes in excess of eight (8) percent.

**Stone check dam:** A small, temporary dam constructed across a swale or drainage ditch. The purpose is to reduce the velocity of concentrated flows, reducing erosion and trapping sediment generated in the ditch.

**Stream:** Generally, a channel between defined banks with a gravel, sand, rock, or clay base that flows at least part of the year. It may be a dry channel part of the year. The Maine Natural Resources Protection Act contains a more detailed definition.

**Structure:** Anything built for the support, shelter, or enclosure of persons, animals, goods, or property of any kind, together with anything constructed or erected with a fixed location on or in the ground. Examples of structures include buildings, utility lines, and roads.

**Temporary access road:** A road constructed solely for project access which is restored to original grade upon project completion, if not sooner. All areas disturbed by access road construction and use will be stabilized, including road ditches, travel ways, and slopes back to vegetated conditions. In most cases, any roadway ditches associated with temporary access roads should be refilled to reestablish pre-development drainage conditions.

**Temporary stabilization:** Mulch, matting, or seed, or a combination thereof, utilized to stabilize soil. Soil stockpiles left in place longer than 14 days must have temporary stabilization.

**Temporary vegetative cover:** An annual seed mixture, typically annual rye and oats.

**Topography:** The contour and elevation of the surface of the ground.

**Turn out:** Water diversion that directs water out of a ditch or off a travel-way and into a vegetated buffer.

**Upland edge:** The area of uplands alongside a wetland, stream, or water body.

**Wastes requiring special handling:** Wastes generated from construction activity including engine oil, hydraulic oil, gear oil, diesel, gasoline, or coolants.

**Water bar:** Constructed bar across an access road or skid trail that directs surface water off the road or trail into a stable vegetated surface or filter strip. They are used as a temporary measure on active roads or when closing roads permanently to prevent erosion.

**Water body:** River, stream, brook, pond, wetland, or tidal area.

**Water resource:** River, stream, brook, pond, wetland, or tidal area.

**Wetland:** An area that is inundated or saturated by surface or groundwater at a frequency and for a duration sufficient to support, and which under normal circumstance do support, a prevalence of wetland vegetation typically adapted for life in saturated soils. The Maine Natural Resources Protection Act contains a more detailed definition.

**APPENDIX B**  
**CONSTRUCTION MATERIALS SOURCE LIST**

**APPENDIX B**  
**CONSTRUCTION MATERIALS SOURCE LIST**

The following list of vendors has been selected given the wide variety of construction materials they offer. The list is not meant to be all-inclusive or an indication of favored vendors.

**W.H. Shurtleff Company (Culverts, Geotextiles)**

One Runway Road  
Suite 8  
South Portland, Maine 04106-6169  
1-800-633-6149  
[www.whshurtleff.com](http://www.whshurtleff.com)

**A. H. Harris (Geotextiles, i.e. Curlex Excelsior Blankets)**

22 Leighton Road Augusta, Maine 04332 (207) 622-0821 <a href="http://www.ahharris.com">www.ahharris.com</a>	585 Riverside Street Portland, Maine 04103 (207) 775-5764
--	---

**North American Green (Erosion control materials)**

Maine Distributor:  
E.J. Prescott  
P.O. Box 600  
32 Prescott Street, Libby Hill Business Park  
Gardiner, Maine 04345  
(207) 582-1851  
[www.ejprescott.com](http://www.ejprescott.com)

**New England Organics (Erosion Control Mulch)**

135 Presumpscot Street, Unit 1  
Portland, ME 04103  
1-800-933-6474  
[www.newenglandorganics.com](http://www.newenglandorganics.com)

**APPENDIX C**  
**OTHER RECOMMENDED REFERENCE**  
**MANUALS**

**APPENDIX C**  
**OTHER RECOMMENDED REFERENCE MANUALS**

Maine Erosion and Sediment Control Best Management Practices (BMPs). Manual for Designers and Engineers. Bureau of Land Resources, Maine Department of Environmental Protection, Augusta, Maine. October 2016.  
[http://www.maine.gov/dep/land/erosion/escbmps/esc\\_bmp\\_engineers.pdf](http://www.maine.gov/dep/land/erosion/escbmps/esc_bmp_engineers.pdf)

Maine Erosion and Sediment Control Practices Field Guide for Contractors. Bureau of Land Resources, Maine Department of Environmental Protection, Augusta, Maine. 2014.  
[http://www.maine.gov/dep/land/erosion/escbmps/esc\\_bmp\\_field.pdf](http://www.maine.gov/dep/land/erosion/escbmps/esc_bmp_field.pdf)

Best Management Practices for Forestry: Protecting Maine's Water Quality. Maine Forest Service, Augusta, Maine. 2004.  
[www.maine.gov/doc/mfs/pubs/bmp\\_manual.htm](http://www.maine.gov/doc/mfs/pubs/bmp_manual.htm)

Forest Transportation Systems: Roads and Structures Manual. Seven Islands Land Company, Bangor, Maine. Third Edition, 1999.

**APPENDIX D**  
**CONSTRUCTION TECHNIQUE ILLUSTRATIONS**

## CULVERT CROSSING



IMPROPER INSTALLATION

- Culvert is undersized, allowing overflow to cross travel-way
  - Insufficient cover thickness over culvert
  - Outlet is not stable, leading to erosion
- Culvert outlet is set too high causing it to be impassable to fish and other aquatic organisms



PROPER INSTALLATION

- Culvert is adequately sized for flow
- Sufficient cover thickness over culvert
- Inlet and outlet are adequately supported by gravel and rock to protect and maintain stability
- Outlet is properly seated at or below stream bottom allowing aquatic organisms to access upstream

## CRANE MATS – WATERBODY CROSSING



IMPROPER INSTALLATION

- Mats not long enough to keep equipment out of water and wetland soils
  - Lacks cross supports which elevate travel mat
- Mats do not extend far enough to protect wetland soils from rutting



PROPER INSTALLATION

- Mats are elevated by cross-supports on stream banks, keeping them up out of water and out of wet soils
  - Water flows under mats
- Mats extend over approaches to crossing protecting soils from rutting and eroding
  - Equipment stays out of water and wetlands



## CRANE MATS – WETLAND CROSSING



**IMPROPER INSTALLATION**

- Long axis of mats is not perpendicular to travel direction
- Mats are working down into wetland causing significant disturbance and picking up mud
  - Mats do not extend beyond wetland edge to solid ground



**PROPER INSTALLATION**

- Correct orientation relative to travel direction
- Entire wetland is spanned, preventing rutting at ends of crossing

## CORDUROY CROSSING



IMPROPER INSTALLATION

- Insufficient corduroy to support equipment
  - Corduroy is sunken into wetland soil
- Approaches are steep, rutted, and are not protected with additional corduroy or slash
  - Flow is interrupted, and water is soiled with mud and silt

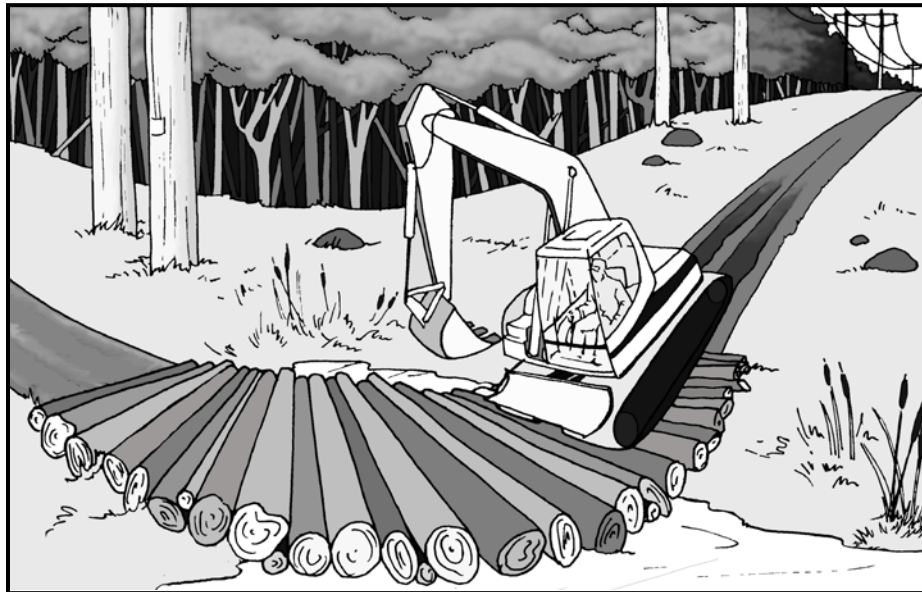

PROPER INSTALLATION

- Adequate amount of layered corduroy to protect soil from rutting
- Approaches are protected from rutting by extension of corduroy beyond edges of crossing
  - Flow is maintained and water is clear of mud and silt

## WATER BARS



### IMPROPER INSTALLATION

- Flow directed to uphill side on upper bar
  - Angle of lower bar is too shallow
- Lower bar does not extend far enough, allowing water to escape around ends
  - Bars are not high enough, allowing water to flow over top, eroding them



### PROPER INSTALLATION

- Bars are at moderate angles
  - There are enough bars to divert all water flowing down road
  - Bars are high enough to prevent water from flowing over them
- Bars extend beyond edges of road, preventing water from flowing around them

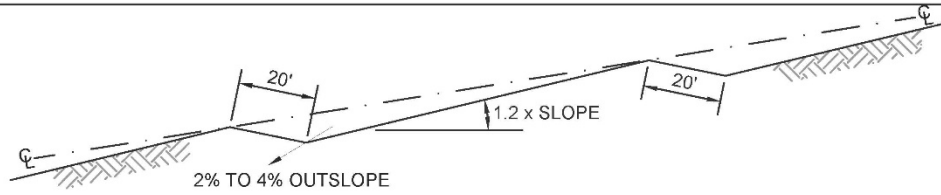

**BROAD BASE DIPS ON ROAD**

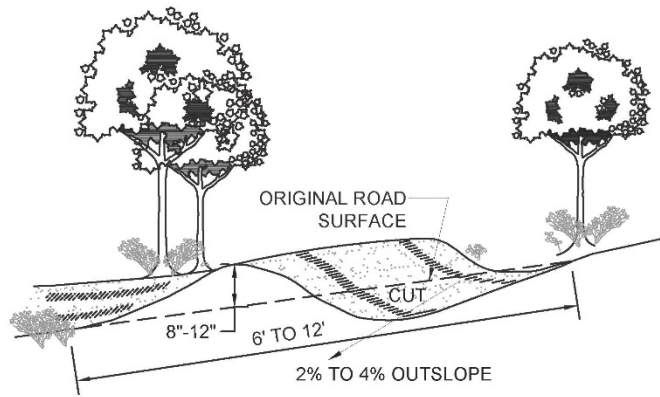

**SHALLOW WATER BAR**

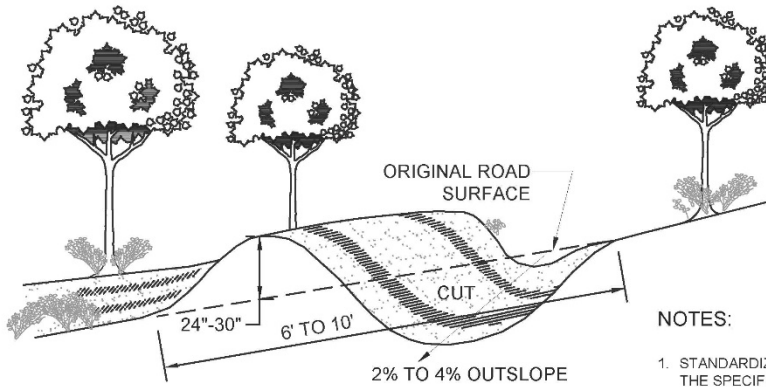

**DEEP WATER BAR**

**NOTES:**

1. STANDARDIZED DESIGNS MUST BE ADAPTED TO THE SPECIFIC SITE.
2. CONSTRUCT WATER BAR IN ACCORDANCE WITH MAINE EROSION AND SEDIMENT CONTROL PRACTICES FIELD GUIDE FOR CONTRACTORS, LATEST EDITION.

SCALE: N.T.S.



CENTRAL MAINE POWER COMPANY

TYPICAL WATER BAR DETAIL

## UPGRADIENT RUNOFF DIVERSION

### NOTES:

1. ANGLE DIVERSION AWAY FROM SLOPE, WITH A 2-3% DOWNWARD GRADIENT.
2. DIVERSION SHALL DISCHARGE DIRECTLY TO EITHER A PLUNGE POOL, LEVEL SPREADER OR OTHER ENERGY DISSIPATER.
3. STABILIZE WITH MATERIAL THAT IS APPROPRIATE FOR THE SLOPE AND EXPECTED RUNOFF (EROSION CONTROL BLANKETS, GRAVEL OR RIPRAP).
4. CONSTRUCT DIVERSION IN ACCORDANCE WITH MAINE EROSION AND SEDIMENT CONTROL PRACTICES FIELD GUIDE FOR CONTRACTORS, LATEST EDITION.

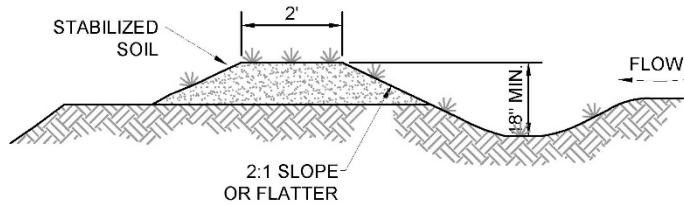

**DIVERSION WITH EXCAVATION**

SCALE: N.T.S.

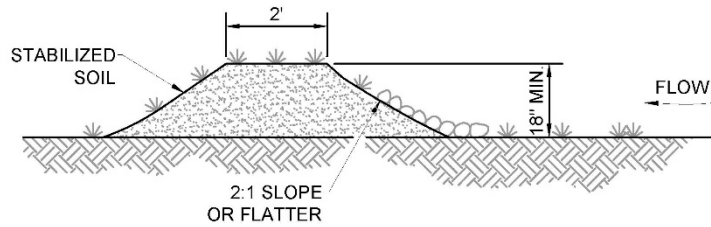

**DIVERSION WITH FILL**

SCALE: N.T.S.



CENTRAL MAINE POWER COMPANY

TYPICAL UPGRADIENT RUNOFF DIVERSION DETAIL

# TEMPORARY SEDIMENT TRAP

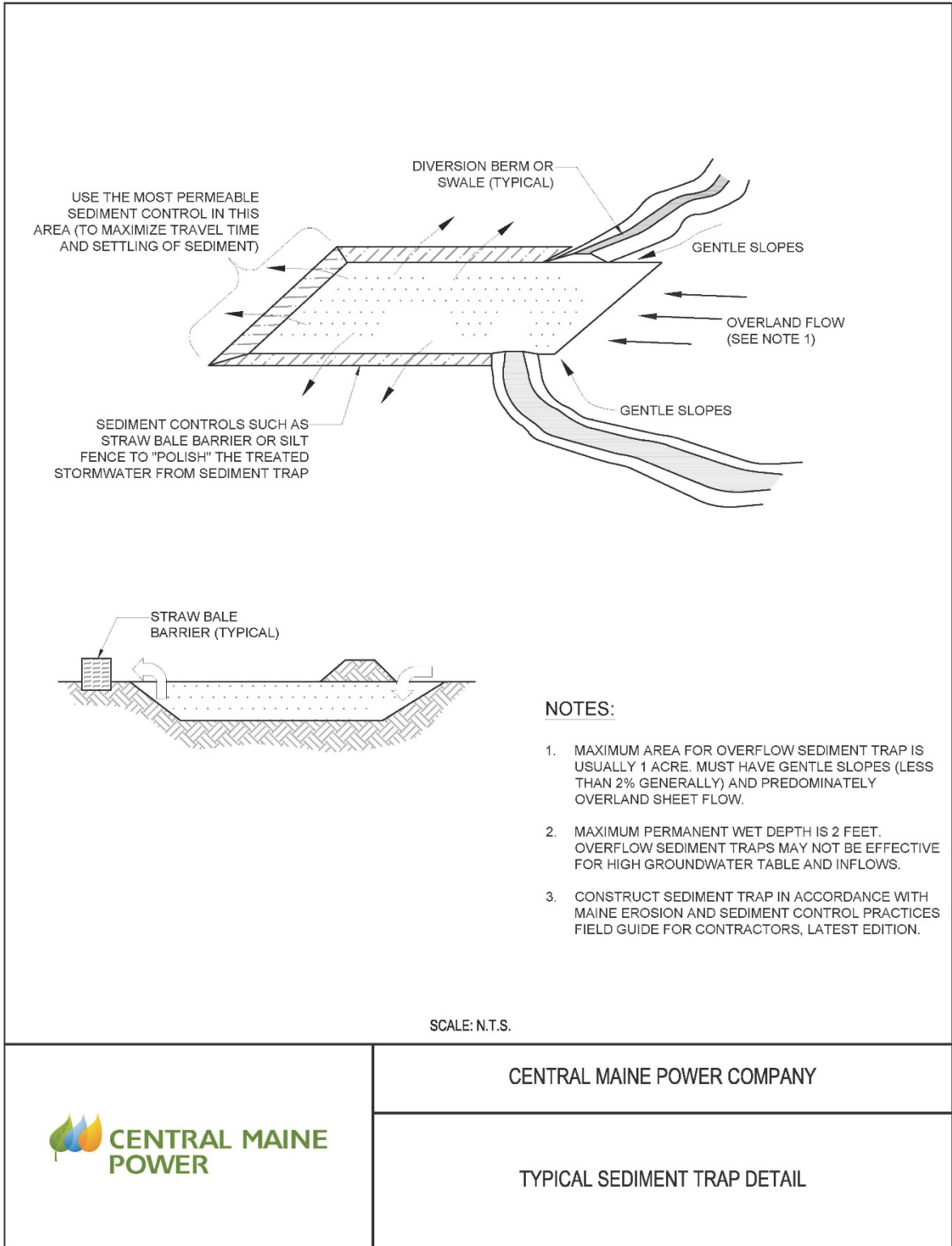



# TEMPORARY SEDIMENT BASIN

**NOTES:**

1. THE BASIN'S LENGTH TO WIDTH RATIO SHALL BE 2:1 OR FLATTER.
2. BASIN SHALL BE LOCATED MORE THAN 100 FEET AWAY FROM ANY MAPPED OR DELINEATED NATURAL RESOURCE AND SHALL NOT DIRECTLY DISCHARGE TO A STREAM.
3. STABILIZE BASIN WITHIN 7 CALENDAR DAYS WITH RIPRAP, EROSION CONTROL MIX OR AN ANCHORED EROSION CONTROL BLANKET.
4. CONSTRUCT BASIN IN ACCORDANCE WITH MAINE EROSION AND SEDIMENT CONTROL PRACTICES FIELD GUIDE FOR CONTRACTORS, LATEST EDITION.

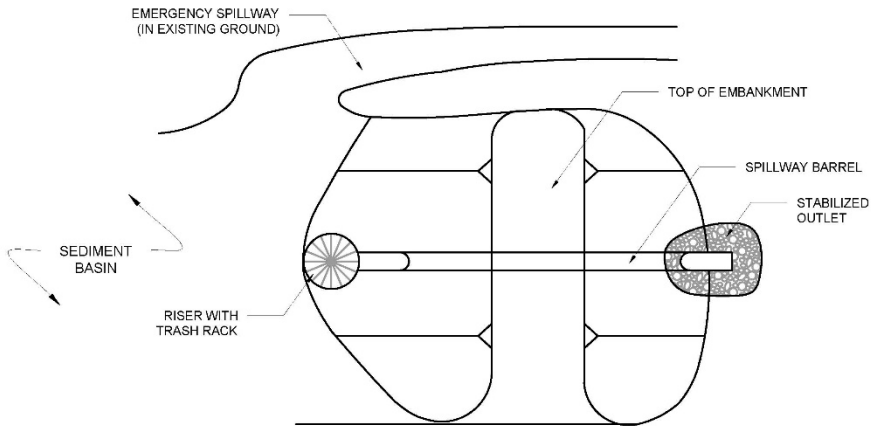

**PLAN**  
SCALE: N.T.S.

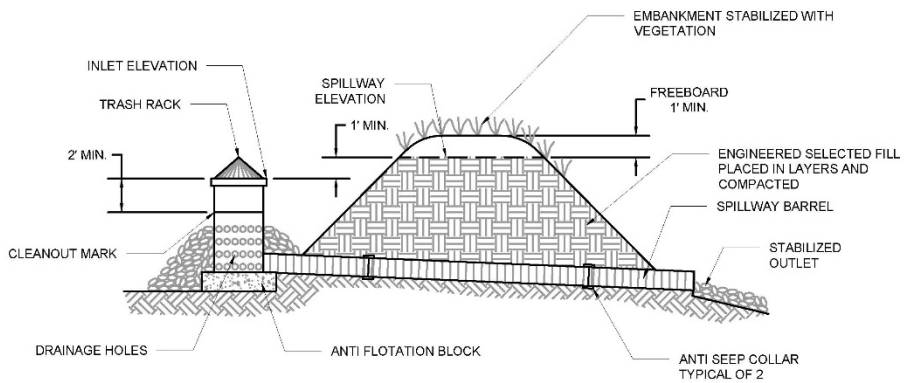

**SECTION**  
SCALE: N.T.S.



CENTRAL MAINE POWER COMPANY

TYPICAL SEDIMENT BASIN DETAIL

**SEDIMENT BARRIER – HAY BALES**  
**PROPER INSTALLATION**

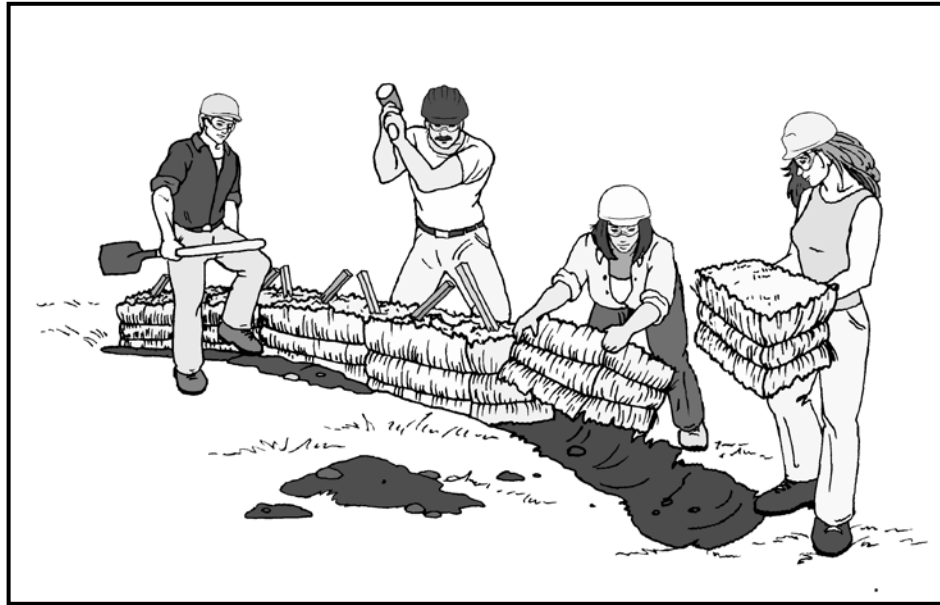

- **Dug trench to key bales into ground**
- **Stakes placed and driven in at angles to snug bales together**
  - **Excess dirt used to cover openings and cracks**

**SEDIMENT BARRIER – SILT FENCE**  
**PROPER INSTALLATION**



- **Dug trench to key material into ground**
  - **Stakes are placed facing away from disturbed area**
- **Excess material on bottom is buried with excess dirt to prevent water from flowing under fence**



## EROSION CONTROL MIX BERM DETAIL

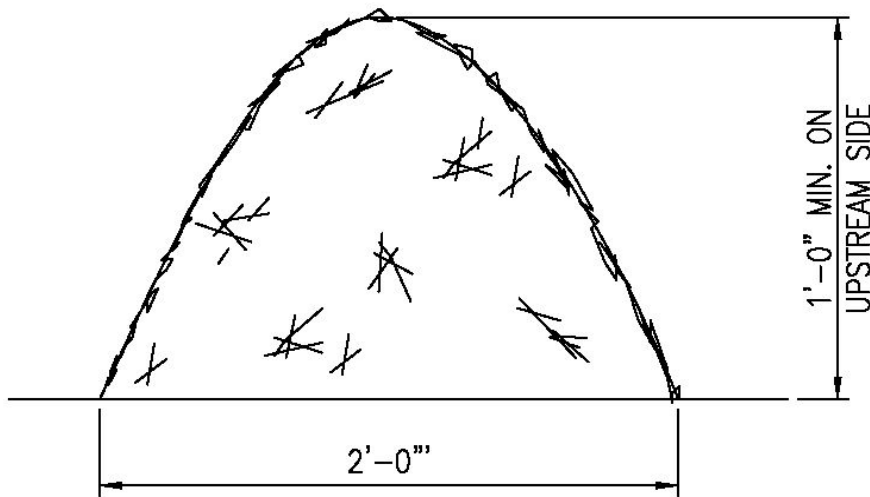

- Use erosion control mix berm in place of silt fence and/or hay bale sediment barriers
- Erosion control soil/bark mix shall consist of: shredded bark, stump grindings, composted bark or flume grit and fragmented wood generated from water-flume log handling systems. The mix shall conform to the following:
  1. pH: 5.0 to 8.0
  2. Screen Size: 6" – 100% passing  
¾" – 70% to 85% passing  
Mix shall not contain large portions of silts, clays or fine sands
  3. Organic material: 20% - 100% (dry weight basis)  
Organic portion must be fibrous and elongated
  4. Soluble salts shall be <4.0 mmhos/cm

## SEDIMENT BARRIER – SILT FENCE

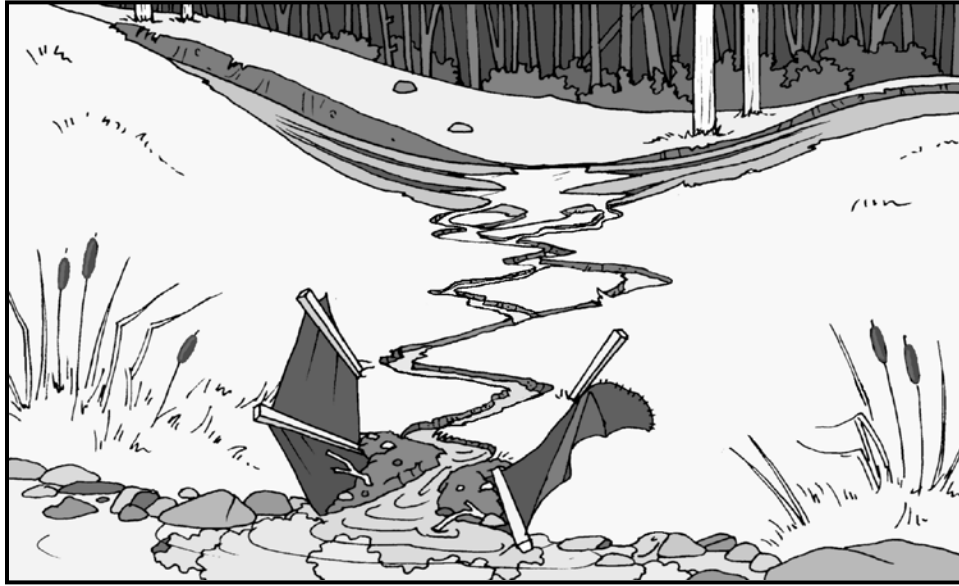

IMPROPER INSTALLATION

- Fence located too far from road and too close to resource
  - Stakes installed on wrong side of fence
- Needs maintenance (restaking, restapling, or even replacement)
  - Placed in concentrated flow



PROPER INSTALLATION

- Adequate distance from road and resource allows road to capture and slow water, and allows silt fence to filter it before reaching resource
  - Stakes placed on correct side; facing resource, while filter fabric faces disturbed area
- Adequate length; fence is long enough and turned uphill at ends to prevent water from escaping around edges

## SEDIMENT BARRIER – HAY BALES



**IMPROPER INSTALLATION**

- Placed in concentrated flow
  - Hay bales are not staked
- Not enough hay bales to adequately capture and slow flow
  - Too far from source of runoff and sediment
- Improper orientation of bales; horizontal grass fibers do not provide adequate filtration, and strings on ground rot and bales to fall apart



**PROPER INSTALLATION**

- Staked properly; bales are secure and snug to one another
- Sufficient number of bales to slow flow and insure that no water escapes around edges
- Positioned close to disturbance, and far from resource to allow proper filtration
  - Vertical orientation of grass fibers provides adequate filtration
    - Placed along contour to capture sheet flow

**APPENDIX E**  
**EROSION AND SEDIMENTATION CONTROL LAW\* 38**  
**M.R.S.A. § 420-C**

**APPENDIX E**

**EROSION AND SEDIMENTATION CONTROL LAW\***

**38 M.R.S.A. § 420-C**

*A person who conducts, or causes to be conducted, an activity that involves filling, displacing or exposing soil or other earthen materials shall take measures to prevent unreasonable erosion of soil or sediment beyond the project site or into a protected natural resource as defined in section 480-B. Erosion control measures must be in place before the activity begins. Measures must remain in place and functional until the site is permanently stabilized. Adequate and timely temporary and permanent stabilization measures must be taken and the site must be maintained to prevent unreasonable erosion and sedimentation.*

*This section applies to a project or any portion of a project located within and organized area of this State. This section does not apply to agriculture fields. Forest management activities, including associated road construction or maintenance, conducted in accordance with applicable standards of the Maine Land Use Regulation Commission, are deemed to comply with this section. This section may not be construed to limit a municipality's authority under home rule to adopt ordinances containing stricter standards than those contained in this section.*

\* The Erosion and Sedimentation Control Law is administered by the Maine Department of Environmental Protection (MDEP), Augusta, Maine. Please contact the MDEP with specific questions regarding this law.

**APPENDIX F**  
**MAINE SLASH LAW\* 12 M.R.S.A. § 9333**

**APPENDIX F**  
**MAINE SLASH LAW\***  
**12 M.R.S.A § 9333**

*§9333. Disposal along railroad and utility lines*

1. **Stumpage owner.** *A stumpage owner, operator, landowner or agent who cuts or causes or permits to be cut any forest growth on lands that are within or border the right-of-way of a railroad, a pipeline, or an electric power, telegraph, telephone or cable line may not place slash or allow it to remain on the ground within the right-of-way or within 25 feet of the nearer side of the right-of-way.*

2. **Construction.** *Slash accumulated by the construction and maintenance of a railroad, a highway, a pipeline or electric power, telegraph, telephone or cable line may not be left on the ground but must be hauled away, burned or chipped. Slash may not be left or place within the right-of-way or within 25 feet of the nearer side of the right-of-way. If a burning permit is denied or revoked under this chapter, the director may allow logs that are too large to be chipped to remain in the right-of-way until the director determines that their removal is economically feasible.*

3. **Utility line maintenance.** *Slash accumulated by the periodic maintenance of a pipeline or an electric power, telegraph, telephone or cable line may be disposed of in the following manner.*

- A. *Slash with a diameter of 3 inches or less may be left in piles on the ground within the maintained portion of the right-of-way. A pile may not be higher than 18 inches from the ground or longer than 50 feet and must be separated from other piles by a minimum of 25 feet in every direction. A buffer strip with a minimum width of 10% of the total width of the maintained right-of-way must be kept totally free of slash with a diameter of 3 inches or less.*
- B. *Slash with a diameter of more than 3 inches must be removed, chipped or limbed and placed on the ground surface. The pieces must be separated and may not be piled one piece over another. Slash of this size may be left within the maintained buffer strips.*
- C. *If a utility line right-of-way is adjacent to a road, slash that is 3 inches or less in diameter must be removed, burned or chipped. Slash with a diameter of more than 3 inches may be left on the ground within the right-of-way and must not be limbed and separated and may not be piled one piece over another. Usable timber products generated from the maintenance of a utility right-of-way may be piled within the right-of-way but must be removed within 30 days.*

\* Note that this is an excerpt from the full text of the law. Please contact the Maine Forest Service, Augusta, Maine, for the full text of the law or with specific questions regarding the Slash Law.

**APPENDIX G**  
**CULVERT SIZES FOR STREAM CROSSINGS**  
**(3X RULE)**



## CULVERT SIZES (ROUND) FOR STREAM CROSSINGS (3x RULE)

### AVERAGE STREAM WIDTH

Take two measurements across the stream from bank to bank where you intend to place the culvert. Measurements should be taken at the normal high water line (NHWL). To find the NHWL during low flow periods look for water stains on rocks or a debris line along the bank. Add the first measurement to the second and divide this number by 2. This equals the average stream width.

**Example: 36in. + 47 in. = 83in. 83÷2 = avg. stream width of 41.5 inches. (Round up to 42in.)**

### AVERAGE STREAM DEPTH

Take 3 measurements from the bottom of the stream to the NHWL.

Add the measurements together and divide this number by 3. This equals the avg. stream depth.

**Example: 12in. + 16in. + 14in. = 42in. 42÷3 = average stream depth of 14 inches.**

### USING THE TABLE

Take the average width and depth figures and determine where they intersect on the table above.

\*For example, for an average stream width of 42 inches (on the left side of the table), and an average stream depth of 14 inches (along the top of the table), the intersect shows a culvert diameter of 48 inches.

Average Stream Width		Average Stream Depth (Inches)														
Feet	Inches	2	4	6	8	10	12	14*	16	18	20	22	24	26	28	30
1	12	12	15	18	21	21	24	30	30	30	30	36	36	36	36	42
1.5	18	12	18	21	24	30	30	36	36	36	42	42	42	42	48	48
2	24	15	21	24	30	30	36	36	42	42	48	48	48	54	54	54
2.5	30	15	21	30	30	36	42	42	48	48	48	54	54	60	60	60
3	36	18	24	30	36	42	42	48	48	54	54	60	60	60	66	66
3.5	42*	18	30	36	36	42	48	48	54	54	60	60	66	66	72	72
4	48	21	30	36	42	48	48	54	54	60	66	66	66	72	72	78
4.5	54	21	30	36	42	48	54	54	60	66	66	72	72	78	78	84
5	60	21	30	42	48	48	54	60	66	66	72	72	78	78	84	84
5.5	66	24	36	42	48	54	60	60	66	72	72	78	78	84	84	90
6	72	24	36	42	48	54	60	66	66	72	78	78	84	90	90	96
6.0	78	24	36	42	54	60	60	66	72	78	78	84	90	90	96	96
7	84	30	36	48	54	60	66	72	72	78	84	84	90	96	96	102
7.5	90	30	42	48	54	60	66	72	78	84	84	90	96	96	102	102
8	96	30	42	48	54	66	66	72	78	84	90	90	96	102	102	108
8.5	102	30	42	48	60	66	72	78	84	84	90	96	102	102	108	108
9	108	30	42	54	60	66	72	78	84	90	96	96	102	108	108	114
9.5	114	30	42	54	60	66	72	78	84	90	96	102	102	108	114	114
10	120	30	48	54	66	72	78	84	90	96	96	102	108	114	114	120
10.5	126	36	48	54	66	72	78	84	90	96	102	108	108	114	120	120
11	132	36	48	60	66	72	78	84	90	96	102	108	114	114	120	126
11.5	138	36	48	60	66	78	84	90	96	102	108	108	114	120	126	126
12	144	36	48	60	66	78	84	90	96	102	108	114	120	120	126	132
12.5	150	36	48	60	72	78	84	90	96	102	108	114	120	126	132	132
13	156	36	54	60	72	78	90	96	102	108	114	114	120	126	132	138
13.5	162	36	54	66	72	84	90	96	102	108	114	120	126	132	132	138
14	168	36	54	66	72	84	90	96	102	108	114	120	126	132	138	144
14.5	174	36	54	66	78	84	90	96	108	114	120	126	126	132	138	144
15	180	42	54	66	78	84	96	102	108	114	120	126	132	138	144	144

**ATTACHMENT C**

**Typical Figure: Erosion and Sedimentation Controls for Structure  
Installation in High Risk Areas**

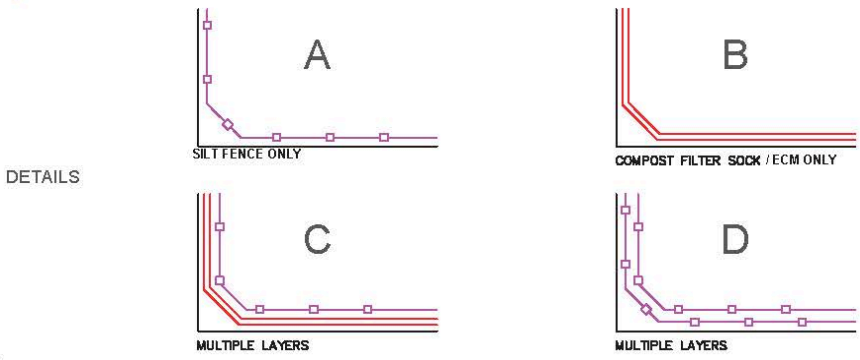
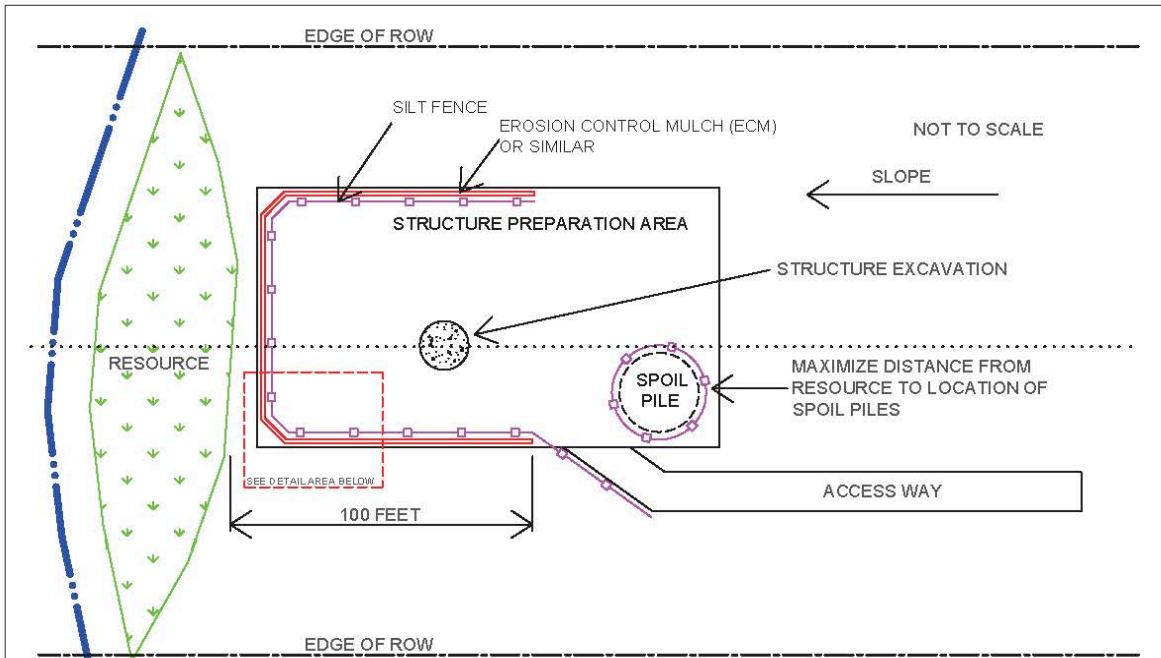

**NOTES:**

1. SPOIL GENERATED AND USED ON THE SAME DAY MAY BE TEMPORARILY STOCKPILED NEAR THE EXCAVATION UNDER DRY WEATHER CONDITIONS ONLY.
2. WHERE PRACTICABLE, INACTIVE SPOIL PILES WITH HIGH SILT OR CLAY CONTENT WILL BE LOCATED A MINIMUM OF 150 FEET FROM RESOURCES.
3. INSTALL SILT FENCE OR EROSION CONTROL MULCH IN THE SINGLE LAYER CONFIGURATION (DETAILS A AND B) AROUND ALL HIGH SILT AND CLAY CONTENT SPOIL PILES LOCATED GREATER THAN 150 FEET FROM RESOURCES.
4. INSTALL EROSION AND SEDIMENTATION CONTROLS PER THE MULTIPLE LAYER CONFIGURATIONS (DETAILS C AND D) IN ALL AREAS, INCLUDING TEMPORARY STOCKPILES, THAT ARE WITHIN 100 FEET OF RESOURCES WHERE THE SOIL HAS HIGH SILT OR CLAY CONTENT.
5. INACTIVE SPOIL PILES WILL BE MULCHED AT A RATE OF 3.5 TONS PER ACRE.

	CENTRAL MAINE POWER COMPANY
	EROSION AND SEDIMENTATION CONTROL FOR STRUCTURE INSTALLATION IN HIGH RISK AREAS

**ATTACHMENT D**  
**Fickett Road Substation Stormwater Plan Revisions**

**STORMWATER MANAGEMENT SYSTEM**

**Prepared for the**

**CENTRAL MAINE POWER COMPANY  
FICKETT ROAD SUBSTATION**



**Location**

**Fickett Road  
Pownal, ME**

**Owner**

**Central Maine Power Company  
83 Edison Drive  
Augusta, Maine 04336**

**Prepared by**



**11733 Chesterdale Road  
Cincinnati, OH 45246  
(513) 326-1500  
September 2017  
REVISED MAY 2018**

# TABLE OF CONTENTS

<b>INTRODUCTION .....</b>	<b>3</b>
FICKETT ROAD SUBSTATION .....	3
PERMITTING REQUIREMENTS .....	3
<b>BASIC STANDARD.....</b>	<b>4</b>
EROSION AND SEDIMENTATION CONTROL .....	4
INSPECTION AND MAINTENANCE .....	4
Scheduled Inspections .....	4
As-Needed Maintenance .....	5
5-Year Re-Certification .....	5
HOUSEKEEPING.....	5
<b>PHOSPHORUS STANDARD .....</b>	<b>5</b>
STORMWATER TREATMENT BMPS.....	6
Crushed Stone Substation Surface.....	6
Grassed Underdrain Soil Filter .....	6
STORMWATER TREATMENT CALCULATIONS .....	6
<b>FLOODING STANDARD .....</b>	<b>7</b>
ACCESS ROAD CULVERT SIZING .....	8
<b>CONCLUSION .....</b>	<b>9</b>
<b>APPENDIX A – BMP INSPECTION &amp; MAINTENANCE CHECKLISTS AND LOGS</b>	
<b>APPENDIX B – CORRESPONDENCE FROM MEDEP TO CMP</b>	
<b>APPENDIX C – STORMWATER COMPUTATIONS</b>	



## **INTRODUCTION**

Central Maine Power Company (CMP) is proposing to construct a new electrical substation as part of the New England Clean Energy Connect (NECEC) Project. The new station will be built on Fickett Road in the town of Pownal in Cumberland County, Maine and will be named the Fickett Road Substation.

Runoff from the proposed electrical substation flows south to Runaround Brook, and then heads north into Runaround Pond. Runaround Pond is listed as a Lake Most at Risk from New Development in Maine Department of Environmental Protection (MeDEP) Chapter 502. The pond then discharges to Runaround Brook, then Chandler Brook, heading downstream to Royal River, then southeast where it discharges into the Atlantic Ocean.

### **Fickett Road Substation**

The existing conditions and proposed grading plans for the proposed Fickett Road Substation are included with this submission as sheets 1077-003-001 SH 001 General Site Plan Existing Conditions and 1077-003-001 SH 002 General Site Plan Proposed Conditions, respectively. The layout of proposed equipment within the yard is shown on SK-FICK-GL Conceptual General Location Plan.

The proposed substation will sit on a 19.61 acre parcel of land that is a mix of flat terrain, steep hills, forest, shrubs and low lying wetlands and includes an existing electric transmission line corridor. The proposed station footprint will be approximately 3.75 acres and will consist of roof top and concrete foundation impervious and evenly graded 3/4" to 1.5" stone for the remainder of the station pad. The access roads leading to the station from the north and east will consist of gravel. The project will consist of a total developed area of 4.87 acres, of which, 3.90 acres will be impervious. The site will be sloped to drain to the south, honoring the existing drainage patterns to the extent practicable. Site stormwater runoff will be treated with a grassed underdrain soil filter, while the stoned yard areas are considered to be treated in place.

### **Permitting Requirements**

The Fickett Road Substation is part of the larger NECEC Project currently being undertaken by CMP. The project is submitted as a whole to the MeDEP for permitting purposes.

The project will require a Stormwater Management Permit and a Site Location of Development Permit because more than 3 acres will be stripped or graded and not revegetated within one year, and because the project will occupy more than 20 acres of land. The project will be required to meet the Basic, General, and Flooding Standards as described in MeDEP Chapter 500. As a result of the Fickett Road Substation discharging to Runaround Brook the project is also required to meet the Chapter 500 Phosphorous Standard. The standards will be met using several erosion and sedimentation control and permanent stormwater management Best Management Practices (BMPs).

## **BASIC STANDARD**

The proposed project will disturb more than one acre of land, requiring compliance with the Basic Standard as described in MeDEP Chapter 500 Section 4B. In order to meet the Basic Standard, the proposed project will be required to address the following:

- Erosion and Sedimentation Control
- Inspection and Maintenance
- Housekeeping

### **Erosion and Sedimentation Control**

Exhibit 14-1 of the Site Law Application contains the manual “Central Maine Power Company - Environmental Guidelines for Construction and Maintenance Activities on Transmission Line and Substation Projects”. This manual addresses general erosion and sedimentation control measures used in many previous transmission and substation projects and has been reviewed and approved by MeDEP. The manual was developed to be consistent with the Maine Erosion and Sediment Control Practices Field Guide for Contractors, 2015, and MeDEP’s Chapter 500.

Specific erosion and sedimentation control BMPs for the Fickett Road Substation project are indicated on sheet 1077-003-004 SH 001 Erosion and Sediment Control Plan. Details of the measures proposed are shown on sheet 1077-003-005 SH 003 Site Details 3 and sheet 1077-003-005 SH 004 Site Details 4. Sheet 1077-003-005 SH 005 Site Details 5 presents a plan for implementing these measures at the site.

### **Inspection and Maintenance**

CMP will ensure that a qualified design engineer inspects the construction site periodically to verify that the stormwater BMPs are constructed in accordance with the plans and specifications shown on the design drawings, and, as needed, during any period when construction activity affecting the stormwater management system occurs, until the site is permanently stabilized. Inspection and Maintenance procedures for the proposed substation are described below. BMP Inspection & Maintenance Checklists and BMP Inspection & Maintenance Logs for each site have been enclosed in Appendix A. The BMP Inspection & Maintenance Checklists outline the inspection frequency/requirements and maintenance/cleanout thresholds for each BMP measure. The enclosed BMP Inspection & Maintenance Logs include specific inspection guidelines for each BMP measure and are the documentation portion of this Plan.

#### ***Scheduled Inspections***

Prior to completion of construction, CMP shall designate a CMP Supervisor and personnel or a contractor as the Site Inspector for each substation. Inspection requirements for each individual BMP measure are specified on the Inspection & Maintenance Checklists in Appendix A.

- QUARTERLY: Inspections of stormwater conveyance, control and treatment measures at each Site are to be performed on a quarterly basis throughout the year. Inspections during winter months may encounter snow and ice cover, frozen ground, snow embankments, dormant vegetation, etc. In these cases, the inspector must use his/her best judgment



interpreting these inspection and maintenance requirements, in order to meet both the stated objectives and the intent of the Plan. The inspection should prevent problems and plan for maintenance in advance of the spring thaw (removing snow piles if they obstruct drainage paths, repairing any damage from snow plows, frost heaves, etc.).

- **FOLLOW-UP:** Additional follow-up inspections will be performed, as needed, depending on the results of routine inspections and site conditions, under the direction of the CMP Supervisor.

### ***As-Needed Maintenance***

Maintenance is to be performed on an as-needed basis, in accordance with recommendations made by the Site Inspector. Routine maintenance will include the immediate repair of eroded channels or gullies; reseeding or sodding of bare ground; removal of trash, leaves and sediment; and control of vegetation. Maintenance issues associated with specific areas and stormwater facilities at each Site are identified on the Inspection & Maintenance Checklists in Appendix A. Disposal of all sediment, debris, and waste shall be in accordance with Maine Solid Waste Management Rules, Chapter 400.

### ***5-Year Re-Certification***

CMP will certify the following to the MeDEP within three months of the expiration of each five-year interval from the date of issuance of the permit:

- All areas of the project site have been inspected for areas of erosion, and appropriate steps have been taken to permanently stabilize these areas.
- All aspects of the stormwater control system have been inspected for damage, wear, and malfunction, and appropriate steps have been taken to repair or replace the facilities.
- The erosion and stormwater maintenance plan for the site is being implemented as written, or modifications of the plan have been submitted to and approved by the department, and the maintenance log is being maintained.

### **Housekeeping**

Housekeeping entails the control or elimination of pollution not specifically related to soil erosion such as spill prevention, dust control, litter removal and dewatering. Housekeeping is addressed within the narrative and on sheet 1077-003-005 SH 004 Site Details 4 for the Fickett Road Substation.

## **PHOSPHORUS STANDARD**

The Fickett Road substation discharges to Runaround Pond and will add more than 20,000 square feet of impervious surface within the watershed of a Lake Most at Risk. For this reason the project is required to meet the MeDEP Chapter 500 Phosphorus Standard. In order to meet the Phosphorus Standard, the project needs to reduce the amount of phosphorus released from the site to calculated allowable levels for the parcel. Phosphorus Worksheet 1 was used to calculate the allowable phosphorus load from the parcel, also known as the phosphorous Budget. Following establishment of

the phosphorous Budget, pre-treatment phosphorous loading from the site and loading from the site following implementation of on site BMPs is calculated using Worksheet 2. For the proposed condition, phosphorous Worksheet 2 was used to calculate post-developed phosphorous export loads from the site. Worksheets 1 and 2 can be found in Appendix C.

## **Stormwater Treatment BMPs**

### ***Crushed Stone Substation Surface***

MeDEP has provided yard construction requirements that allow for reduced *Export Coefficients* and *Treatment Factors* to be applied to the substation's stone surface for treatment related to meeting the Phosphorous Standard. In email correspondence following MeDEP's 2008 letter MeDEP has indicated that phosphorous loading and phosphorous removal associated with the station pad may be calculating using an *Export Coefficient* of 0.30 and a *Treatment Factor* of 0.10 for the ***Crushed Stone Substation Surface***. The email correspondence can be found in Appendix B.

### ***Grassed Underdrain Soil Filter***

Runoff from the vegetated developed area along the west side of the station pad will be treated in a Grassed Underdrain Soil Filter. Pretreatment will be accomplished by flowing runoff through a vegetated swale and into a pre-treatment forebay before entering the filter area. Additionally, areas of the station pad and the rooftop surfaces within the pad will be treated within the Soil Filter following treatment within the crushed stone.

The Grassed Underdrain Soil Filter is comprised of an 18"-thick layer of a silty sand and organic material mix. The underdrain system consists of 6" perforated pipe within a 12"-thick layer of underdrain material. The filter is proposed partially within an existing wetland and within areas believed to have elevated groundwater conditions. An impermeable liner has been incorporated into the filter to allow for proper dewatering and prevent oversaturation of the filter media by groundwater prior to rain events. A detail of the underdrained soil filter is shown on sheet 1077-003-003 SH 001 Stormwater Treatment Plan. Underdrained soil filter sizing calculations are provided in Appendix C.

## **Stormwater Treatment Calculations**

In addition to using the station stone as a BMP, a downstream Soil Filter is proposed to further reduce post developed phosphorous exports from the site by providing primary treatment for developed areas surrounding the pad and by further treating runoff from the stone pad as part of a two-tier treatment train utilizing the ***Crushed Stone Substation Surface*** treatment with a downstream soil filter. For parts of the site (pad, rooftops) utilizing the two-tier treatment train, a calculated Treatment Factor of 0.1 was used.

*Export Coefficients* for the proposed surfaces were used to calculate pre-treatment loading and *Treatment Factors* for the proposed BMPs were used to calculate load reductions and subsequent post-developed phosphorous export loads. As shown in Worksheet 1, the Budget for the parcel was calculated to be 0.51 pounds per year and as seen in Worksheet 2, a post developed, post treatment phosphorous export load of 0.45 is achieved.

Typical sizing of Soil Filters for adherence to the Phosphorous Standard requires that the filter have capacity to contain the standard water quality volume ( $BMP_{ST}$ ) which is the volume required for adherence to the General Standard, plus additional volume calculated using a prescribed Treatment Factor. The  $BMP_{ST}$  volume plus the additional phosphorous treatment volume requirement constitute the total volume capacity required for BMPs used to meet the Phosphorous Standard and is known as  $BMP_{TF}$ . The Fickett Road substation yard is self-treating and does not require additional BMPs for adherence to the General Standard, therefore the soil filter was sized to have capacity for the difference between the  $BMP_{ST}$  and  $BMP_{TF}$  for areas of the yard plus the full  $BMP_{TF}$  for developed landscaped areas outside the yard that are not treated for the general standard within the yard stone. Appendix C contains calculations for sizing the soil filter based on these parameters.

The hydraulic modeling report for the entire project site is also included with this submission in Appendix C. The calculations were developed using USDA TR-55 methodology. The model results in Appendix C illustrate how the site drainage and stormwater management infrastructure will function during the 2-, 10- and 25-year storms. The report also contains the hydrologic calculations for the project. The modeling results were used to confirm that adequate water quality volume (WQV) will be provided below the required 18" depth for the Grassed Underdrain Soil Filter.

## FLOODING STANDARD

The project is required to meet the MeDEP Chapter 500 Flooding Standard; the addition of over 3 acres of impervious area requires a decrease in peak stormwater runoff as a result of the proposed development. The site is situated entirely within existing HSG Type D soils. Pre-developed and post-developed Curve Numbers for the project can be found in Appendix C and on the project drainage area maps (Sheets 1077-003-003 SH 002 and SH 003). The MeDEP letter describing the construction requirements that allow the General Standard requirements to be met for the yards within the ***Crushed Stone Substation Surface*** also prescribes allotted Curve Numbers for use when calculating runoff from the stone section. Pre-Developed Curve Numbers for the project site depicted on the drainage area maps indicate existing Curve Numbers ranging from 73 to 77. MeDEP prescribes a developed Curve Number for the stone station surface over HSG Type D soils of 60. As existing drainage patterns have been maintained to the extent practicable, the sizes and times of concentration have not been significantly altered with this project. Due to the decreased Curve Numbers across the stone station pad (CN decreased to 60 for these areas), post-development peak flows were calculated to be less than or relatively equal to the pre-development peak flows without the need for on-site stormwater attenuation. Tables 1 and 2 show the pre- and post-development peak flows at each analysis point. Tables 3 through 5 show the comparisons between the pre-developed and post-developed peak flow rates

Table 1 - Pre-Developed Peak Flow Rates

Analysis Point	2-Year Flow Rate (CFS)	10-Year Flow Rate (CFS)	25-Year Flow Rate (CFS)
A	2.25	5.70	7.51
B	3.98	10.12	13.36
C	0.27	0.66	0.86
D	0.13	0.30	0.38

Table 2 - Post-Developed Peak Flow Rates

Analysis Point	2-Year Flow Rate (CFS)	10-Year Flow Rate (CFS)	25-Year Flow Rate (CFS)	Peak 2-Year Flow Rate at Outfall (If Subsheds Present)	Peak 10-Year Flow Rate at Outfall (If Subsheds Present)	Peak 25-Year Flow Rate at Outfall (If Subsheds Present)
A	2.33	5.71	7.47	N/A	N/A	N/A
B1	1.30	4.05	5.55	2.06	5.73	7.71
B2	1.84	5.14	6.91			
C	0.15	0.37	0.48	N/A	N/A	N/A
D	0.13	0.30	0.38	N/A	N/A	N/A

Table 3 – Flow Rate Comparison, 2-Year

Analysis Point	PRE 2-Year Flow Rate (CFS)	POST 2-Year Flow Rate (CFS)	Change in Peak Flow Rate (CFS)
A	2.25	2.33	0.08
B	3.98	2.06	(1.92)
C	0.27	0.15	(0.12)
D	0.13	0.13	0.00

Table 4 – Flow Rate Comparison, 10-Year

Analysis Point	PRE 10-Year Flow Rate (CFS)	POST 10-Year Flow Rate (CFS)	Change in Peak Flow Rate (CFS)
A	5.70	5.71	0.01
B	10.12	5.73	(4.39)
C	0.66	0.37	(0.29)
D	0.30	0.30	0.00

Table 5 – Flow Rate Comparison, 25-Year

Analysis Point	PRE 25-Year Flow Rate (CFS)	POST 25-Year Flow Rate (CFS)	Change in Peak Flow Rate (CFS)
A	7.51	7.47	(1.04)
B	13.36	7.71	(5.65)
C	0.86	0.48	(0.38)
D	0.38	0.38	0.00

### Access Road Culvert Sizing

An approximately 200' long gravel access drive is proposed extending from Fickett Road to the proposed substation pad. The road will be graded to slope longitudinally downward to a low point between the station pad and Fickett Road and will be graded to have a 2% minimum cross slope to carry stormwater runoff from the road surface. Surface runoff from areas upstream of the new access

drive currently flow within a poorly defined ditch along Fickett Road and will be required to pass beneath the road via a proposed 15” reinforced concrete culvert.

The culvert is expected to serve a drainage area of approximately 0.68 acres having a runoff Curve Number of 75 and with a time of concentration of 5 minutes. The drainage area hydrology was modeled in AutoDesk’s Storm and Sanitary Analysis program to develop post-developed peak flow rates to the culvert in the 2-, 10- and 25-year storm events. Hydraulic analysis of the culvert was completed using AutoDesk’s Hydraflow Express analysis tool to confirm flow capacity and check for flooding. Hydrologic model outputs including peak flow rates can be found in Appendix C in the *Proposed Conditions Hydraulic/Hydrologic Report*. The *Culvert Report* in Appendix C demonstrates the anticipated performance of the culvert during a 25-year event including flow regime and hydraulic grade line elevations at both upstream and downstream ends.

## **CONCLUSION**

The NECEC Project will require a Stormwater Management Permit, and will be required to meet the Basic, Phosphorous and Flooding Standards as described in MeDEP Chapter 500. The Basic Standard shall be met at the Fickett Road Substation through Erosion and Sedimentation Control, Inspection and Maintenance, and Housekeeping, as described in this narrative and the attached checklists, logs and plans. The Flooding Standards shall be met at the Fickett Road Substation by using the MeDEP approved substation yard stone section, as illustrated on the attached stormwater treatment plans. The proposed culvert beneath the new access drive has been sized to prevent flooding of the road during the 25-year storm event. The Phosphorus Standard shall be met using the MeDEP approved substation yard section and a Grassed Underdrain Soil Filter.

# **APPENDIX A – BMP INSPECTION & MAINTENANCE CHECKLISTS AND LOGS**

## APPENDIX A-1: BMP INSPECTION & MAINTENANCE CHECKLIST

Central Maine Power Company – Fickett Road Substation  
Pownal, Maine

BMP MEASURE	INSPECTION REQUIREMENTS*	MAINTENANCE/CLEANOUT THRESHOLDS
Vegetated Swales	<p>Inspect swale for accumulated sediment, debris and other obstructions.</p> <p>Inspect swales for evidence of erosion, gullies, or slumping of the side slopes.</p> <p>Inspect swales for bare ground/sparse vegetation.</p> <p>Monitor vegetative growth.</p>	<p>Clean as needed and dispose of properly.</p> <p>Repair and re-seed as necessary. Consult engineer if problem persists. Areas of persistent erosion may need to be armored.</p> <p>Re-seed as necessary. Soil may need to be scarified if compacted soils are present.</p> <p>Mow vegetation in swales to roughly six inches at least once and no more than two times a year. To be performed between June 15<sup>th</sup> and August 30<sup>th</sup>. Fertilizer containing phosphorus is prohibited, except when establishing new turf or vegetation on bare soil.</p>
Check Dams	<p>Inspect check dams to ensure the center is lower than the edges.</p> <p>Inspect check dams for stone displacement, erosion, concentrated flow or channelization.</p> <p>Inspect check dams for accumulated sediment, debris or other obstructions.</p>	<p>Repair as necessary.</p> <p>Repair any damaged areas. Consult engineer if problem persists.</p> <p>Clean as needed and dispose of properly. Sediment must be removed before it exceeds one half the original height of the check dam.</p>
Revegetated Areas	<p>Inspect revegetated areas for evidence of erosion, concentrated flow, or channelization.</p> <p>Inspect revegetated areas for bare ground/sparse vegetation.</p>	<p>Repair and re-seed as necessary. Consult engineer if problem persists. Areas of concentrated flow where rills and gullies are present may need to be armored</p> <p>Re-seed as necessary. Soil may need to be scarified if compacted soils are present. Fertilizer containing phosphorus is prohibited, except when establishing new turf or vegetation on bare soil.</p>
Gravel Access Roads	<p>Inspect access road shoulder for accumulated sand/sediment.</p> <p>Inspect grade on access road and shoulder to ensure stormwater is not impeded by accumulation of materials or false ditches.</p> <p>Inspect access road to ensure that there is no rutting, wash-boarding, frost heaves, potholes, or ponding occurring.</p>	<p>Remove sand/sediment as necessary.</p> <p>Repair grade as necessary.</p> <p>Repair by replacing gravel and re-grading as necessary.</p>

\*Inspections are to be performed on a monthly basis with additional follow-up inspections and maintenance as needed.

## APPENDIX A-1: BMP INSPECTION & MAINTENANCE CHECKLIST

Central Maine Power Company – Fickett Road Substation  
Pownal, Maine

BMP MEASURE	INSPECTION REQUIREMENTS*	MAINTENANCE/CLEANOUT THRESHOLDS
Grassed Underdrained Soil Filter	<p>Inspect entering swale, basin and outlet structure for accumulated sediment, debris and other obstructions.</p> <p>Inspect filter for evidence of erosion, gullies, or slumping of the side slopes.</p> <p>Inspect filter for bare ground/sparse vegetation.</p> <p>Monitor vegetative growth.</p> <p>Test Ball Valve operating nuts and open and close for operability.</p>	<p>Clean as needed and dispose of properly.</p> <p>Repair and re-seed as necessary. Consult engineer if problem persists. Areas of persistent erosion may need to be armored.</p> <p>Re-seed as necessary. Soil may need to be scarified if filter media becomes compacted.</p> <p>Mow vegetation in impoundment to roughly six inches at least once and no more than two times a year. To be performed between June 15<sup>th</sup> and August 30<sup>th</sup>. Fertilizer containing phosphorus is prohibited, except when establishing new turf or vegetation on bare soil.</p> <p>Replace ball valve if not in good operating condition.</p>
Crushed Stone Substation Surface	<p>Inspect crushed stone areas for accumulated sand/sediment.</p> <p>Inspect substation surface to ensure that there is no ponding occurring.</p>	<p>Remove sand/sediment as necessary.</p> <p>Repair by re-grading as necessary.</p>

\*Inspections are to be performed on a monthly basis with additional follow-up inspections and maintenance as needed.



## APPENDIX A-2: BMP INSPECTION & MAINTENANCE LOG

Central Maine Power Company – Fickett Road Substation  
Pownal, Maine

BMP MEASURE (Refer to Appendix B-1 & the O&M Plan)	Inspector(s):			Inspection Type: Monthly [ ] Follow-up [ ]	Photos Taken: Yes [ ] No [ ]	Date:
<b>VEGETATED SWALES</b>						
	<b>YES*</b>	<b>NO</b>	<b>INITIALS</b>	<b>OBSERVATIONS</b>	<b>CORRECTIVE ACTIONS/REPAIR ACTIVITY</b>	<b>DATE COMPLETED &amp; BY WHOM (Refer to any contractor service logs)</b>
<b>Swale along Northwesterly side of yard</b>						
1. Is there an accumulation of sediment, debris and/or other obstructions?						
2. Is there any evidence of erosion, gullies or slumping of the side slopes?						
3. Are there areas of bare ground or sparse vegetation?						
4. Has vegetation been mowed to a length roughly 6" this year?						
<b>CHECK DAMS</b>						
<b>Check Dams in Swales</b>						
1. Are the edges of the check dams higher than the center?						
2. Is there any evidence of stone displacement, erosion, concentrated flow or channelization?						
3. Is there an accumulation of sediment, debris and/or other obstructions?						

## APPENDIX A-2: BMP INSPECTION & MAINTENANCE LOG

Central Maine Power Company – Fickett Road Substation  
Pownal, Maine

<b>BMP MEASURE</b> (Refer to Appendix B-1 & the O&M Plan)	Inspector(s):			Inspection Type: Monthly [ ] Follow-up [ ]	Photos Taken: Yes [ ] No [ ]	Date:
	YES*	NO	INITIALS	OBSERVATIONS	CORRECTIVE ACTIONS/REPAIR ACTIVITY	DATE COMPLETED & BY WHOM (Refer to any contractor service logs)
<b>REVEGETATED AREAS</b>						
<b>Revegetated Areas along Access Road</b>						
1. Is there any evidence of erosion, concentrated flow or channelization?						
2. Are there areas of bare ground or sparse vegetation?						
<b>Revegetated Areas on all sides of the station</b>						
1. Is there any evidence of erosion, concentrated flow or channelization?						
2. Are there areas of bare ground or sparse vegetation?						
<b>GRAVEL ACCESS ROADS</b>						
<b>Access Road to Entrance</b>						
1. Is there an accumulation of sand and/or sediment in the road shoulder?						
2. Does the grade across the road section allow stormwater to drain off the roadway?						
3. Are there any signs of rutting, wash-boarding, frost heaves, potholes or ponding?						

## APPENDIX A-2: BMP INSPECTION & MAINTENANCE LOG

Central Maine Power Company – Fickett Road Substation  
Pownal, Maine

BMP MEASURE (Refer to Appendix B-1 & the O&M Plan)	Inspector(s):			Inspection Type: Monthly [ ] Follow-up [ ]	Photos Taken: Yes [ ] No [ ]	Date:
<b>GRASSED UNDERDRAINED SOIL FILTER</b>	<b>YES*</b>	<b>NO</b>	<b>INITIALS</b>	<b>OBSERVATIONS</b>	<b>CORRECTIVE ACTIONS/REPAIR ACTIVITY</b>	<b>DATE COMPLETED &amp; BY WHOM (Refer to any contractor service logs)</b>
<b>West side of station yard and north of Access Road</b>						
1. Is there an accumulation of sand and/or sediment in the swale or basin?						
2. Is there any evidence of erosion, gullies or slumping of the side slopes?						
3. Are there areas of bare ground or sparse vegetation?						
4. Is the ball valve clean and operable?						
<b>CRUSHED STONE SUBSTATION SURFACE</b>						
<b>Fenced-in area of the Substation and aprons</b>						
1. Is there an accumulation of sand/sediment in crushed stone areas?						

## **APPENDIX B – CORRESPONDENCE FROM MEDEP TO CMP**



STATE OF MAINE  
DEPARTMENT OF ENVIRONMENTAL PROTECTION

JUN 11 2008

JOHN ELIAS BALDACCI  
GOVERNOR

DAVID P. LITTELL  
COMMISSIONER

June 5, 2008

Roy Koster  
Central Maine Power  
83 Edison Drive  
Augusta, ME 04336

RE: DEP Stormwater Management Regulations and how they apply to  
Central Maine Power Company Substations and Switchyards

Dear Mr. Koster:

I am writing to provide clarification on how substations and switchyards designed by Central Maine Power Company (CMP) can meet DEP Stormwater Management rules, Chapter 500 and the Site Location of Development Law. This letter supersedes a previous DEP letter on this subject dated February 29, 2008 and is a follow-up to further discussions between CMP and DEP staff.

Based on the report prepared by John Simon of Balance Engineering, dated March 8, 2008, regarding the stormwater runoff coefficient at CMP substations and switchyards, the required gravel fill and surface nature of these structures performs differently than most common construction practices and a modeling variance will be allowed for CMP substations and switchyards as follows:

When Flooding Standard requirements apply to a CMP project, modeling must demonstrate that peak runoff from the substation structure does not exceed predevelopment flow rates at the property line. Because of the permeability plus storage within the gravel fill and roughness of the crushed rock surface, the curve number (CN) specified in John Simon's report (March 2008) may be used for the substation area. As reported, a CN of 55 may be used for substations and switchyards that are built on areas that are mapped as HSG "A", "B", and "C", and a CN of 60 must be used when the area is mapped as HSG "D" for the HydroCAD model. However, all impervious surfaces will have to be added for an averaged curve number.

The General Standards of Chapter 500 (water quality) will be considered as met by the CMP substation/switchyard design specifications as long as the structure includes the typical CMP substation profile overlaying the natural ground surface. The soil layers within the CMP substation profile consist of 4 inches of crushed stone, 50:50 mix of 1.5"

AUGUSTA  
17 STATE HOUSE STATION  
AUGUSTA, MAINE 04333-0017  
(207) 287-7688 FAX: (207) 287-7826  
RAY BLDG., HOSPITAL ST.

BANGOR  
106 HOGAN ROAD  
BANGOR, MAINE 04401  
(207) 941-4570 FAX: (207) 941-4584

PORTLAND  
312 CANCO ROAD  
PORTLAND, MAINE 04103  
(207) 822-6300 FAX: (207) 822-6303

PRESQUE ISLE  
1235 CENTRAL DRIVE, SKYWAY PARK  
PRESQUE ISLE, MAINE 04769-2094  
(207) 764-0477 FAX: (207) 760-3143

and 0.75" diameter stone overlaying 18 inches or more of gravel fill, MDOT 703.06 Type A. Saturation within the granular fill will detain and provide treatment for the one-inch design standard under that requirement. Groundwater can never be any higher than 18 inches below the top of the gravel fill. Other treatment considerations will need to be provided for all impervious structures anticipated on the substation and switchyard and for the roadway.

The Basic Standards of Chapter 500 (erosion and sedimentation control, inspection and maintenance, and housekeeping) will be met by the standard CMP substation and switchyard design specification and erosion control/construction plan as developed by CMP for each Stormwater Management application. These are minimum erosion control measures that will need to be maintained until the site is fully stabilized. However, based on site and weather conditions during construction, additional erosion control measures may be needed.

While there are several ways to approach the design standards discussed above, these must be considered the minimum requirements in meeting the Stormwater Management and Site Location of Development Laws. However, in some situations where the local hydrology and site conditions warrant more resource protection, additional BMPs may be required. Also, the access drive and associated roadside swales are included in the disturbed area for permitting purposes and the treatment of these areas must be addressed separately from the substation or switchyard and be treated with standard practices. The natural hydrology of these areas will need to be maintained and will have to meet all applicable standards as established in Chapter 500 (page 11, Section 5).

I hope this addresses your request and will make the DEP permitting process more straight forward. If you have further questions, please contact Marianne Hubert at (207) 287-4140.

Sincerely,

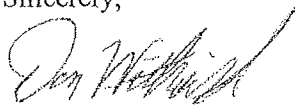

Don Witherill, Director  
Watershed Management Division  
Bureau of Land and Water Quality

Cc: Marianne Hubert, PE, DEP program manager  
Andy Fisk, DEP L&W Bureau Director  
Dan Butler, PE, TRC  
Gerry Mirabile, CMP

---

**From:** Gungor, Kerem [mailto:Kerem.Gungor@maine.gov]  
**Sent:** Wednesday, August 23, 2017 1:57 PM  
**To:** Volock, Kenny  
**Subject:** RE: CMP Substation Yard Treatment Clarifications

Hi Kenny,

Here are my answers:

*Is there a point at which we can no longer consider the concrete and roof area within a substation to be treated through the 4" stone and 18" MDOT Type "A" gravel station yard section?*

I took into account the storage volume provided by the underlying 18" gravel layer for Coopers Mill substation minor revision I reviewed. Same approach can be followed for NECEC:

Storage Volume Provided for Treatment (cf) = (Substation Yard Area excluding the impervious surfaces (sf)) x 2 ft x 0.3 (assumed porosity for the substation yard profile)

Storage Volume Required for the Treatment of the Impervious Surfaces (cf) = Impervious surface (i.e. concrete, roof) (sf) x (1/12) (ft) (one-inch storage requirement for the impervious surfaces)

Therefore, one unit area of stone yard can treat up to 7 unit areas of impervious area (I would recommend staying on the conservative side, not going this far). You do not need to provide additional treatment for the roof at Merrill Road substation.

*How is the station yard section considered when it comes to phosphorous treatment?*

Considering the storage volume and structure of the station yard, I would use the minimum treatment factor, **0.1** as given for the infiltration measures in **Table 4.1** of the Phosphorus Control Manual. For the concrete surfaces and roof, you can use the export factor of **0.5 lb/ac/yr**. For the substation yard, the export factor of **0.3 lb/ac/yr** can be used.

Please let me know if you have any more questions.

Best,

*Kerem Gungor, Ph.D., P.E.*

Environmental Engineer, Central Maine Region

Bureau of Land Resources | Land Division

Maine Department of Environmental Protection

(207) 446-3915 | [kerem.gungor@maine.gov](mailto:kerem.gungor@maine.gov)

---

**From:** [kenny.volock@powereng.com](mailto:kenny.volock@powereng.com) [<mailto:kenny.volock@powereng.com>]

**Sent:** Wednesday, August 23, 2017 12:03 PM

**To:** Gungor, Kerem

**Subject:** CMP Substation Yard Treatment Clarifications

Kerem,

Thank you for your input regarding stormwater management and erosion control during the NECEC Pre-Application last Thursday. I do have a couple follow-up questions that I would like some clarification on:

Is there a point at which we can no longer consider the concrete and roof area within a substation to be treated through the 4" stone and 18" MDOT Type "A" gravel station yard section?

Since we typically call for 6" of stone, I've always assumed the extra 2" of stone is what provided the additional water quality volume for the roof and concrete areas. Depending on what you use for porosity of the stone (0.3 to 0.4), you would have 0.6" to 0.8" available, enough for 0.6 acres to 0.8 acres of roof/concrete per acre of stone yard. This equates to 37.5% to 44.4% roof/concrete area.

A typical substation yard has only around 2% to 5% roof/concrete area, so it is negligible. However, at Merrill Road, with a very large building, that percentage could approach 30%. I would like to know, prior to submission, if we will be able to consider the runoff from the building roof as treated by the yard, or if we will need to make separate provisions.

How is the station yard section considered when it comes to phosphorous treatment?

The 2008 letter from MeDEP to CMP discusses the Flooding and General Standards, but does not discuss the Phosphorous Standard. Can we assume the yard to have the same base treatment factor of 0.4 as the other BMPs? Or is there some other base treatment factor we should be using?

Any input you could provide in resolving these two outstanding issues would be greatly appreciated.



## **APPENDIX C – STORMWATER COMPUTATIONS**





**EXISTING CONDITIONS HYDRAULIC SUMMARY**

DRAINAGE AREA	2-YEAR FLOW RATE (CFS)	10-YEAR FLOW RATE (CFS)	25-YEAR FLOW RATE (CFS)
A	225	570	751
B	398	1012	1336
C	027	086	086
D	013	030	038

- LEGEND**
- 750 — EX. MAJOR CONTOUR
  - 744 — EX. MINOR CONTOUR
  - TC — EX. TIME OF CONCENTRATION
  - EX. SOIL BOUNDARY
  - EX. OVERHEAD UTILITY
  - ▲ EX. FLOW DIRECTION ARROW
  - ▬ EX. DRAINAGE BOUNDARY
  - ▬ EX. PROPERTY BOUNDARY
  - ◻ EX. WETLAND
  - ANALYSIS POINT
  - \* SITE IS ENTIRELY HSG TYPE D SOILS
  - ✕ EX. BRUSH
  - ▨ EX. WOODS

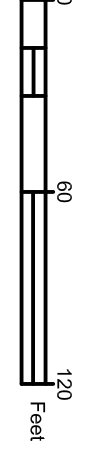
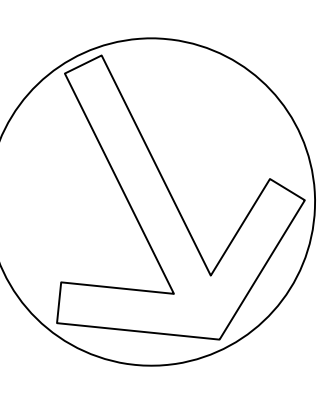

**ISSUED FOR PERMITTING**  
NOT FOR CONSTRUCTION 05/29/18

REV.	DESCRIPTION	DATE	BY	CK	APP	OWNER ENGINEER	APPROVAL STAMP	PRE Stamp

**CONFIDENTIAL, PROPRIETARY and TRADE SECRET INFORMATION**

USA ENGINEERING  
Property of IBERDROLA, USA

**CMP**  
IBERDROLA - USA

PRE-DEVELOPMENT STORMWATER PLAN  
SH 2 OF 3

FICKETT ROAD/1077 POWNAL, ME

SCALE: 1" = 80' FILE: 1077-003-003-002.DWG

REV. 1077-003-003 A



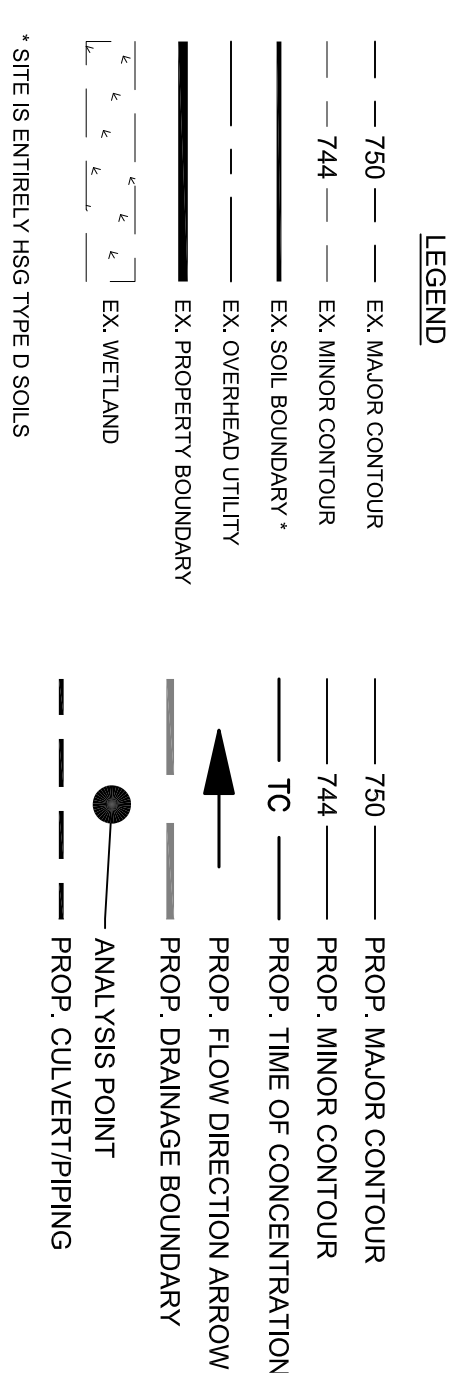
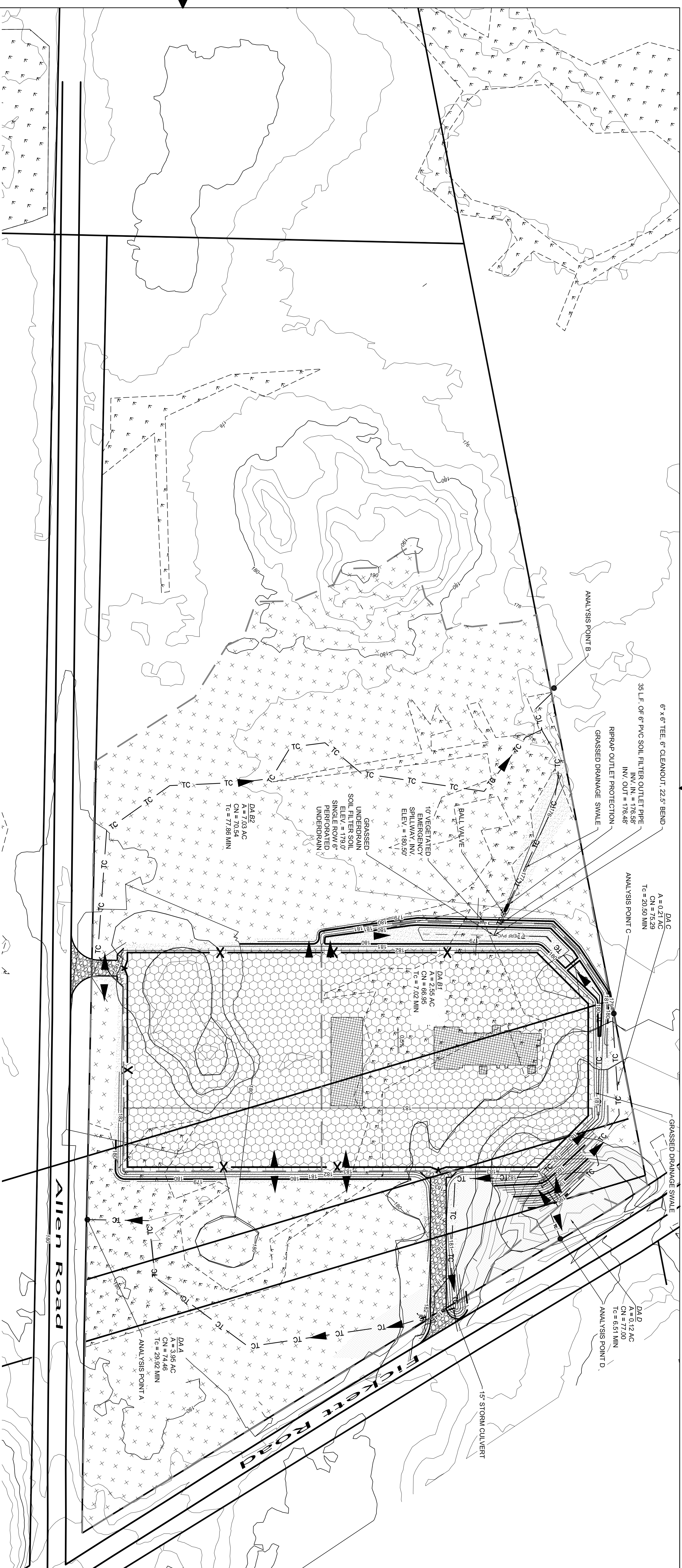

**PROPOSED CONDITIONS HYDRAULIC SUMMARY**

2 - YEAR FLOW RATE (CFS)	10 - YEAR FLOW RATE (CFS)	25 - YEAR FLOW RATE (CFS)	PEAK 2 - YEAR FLOW RATE AT OUTFALL (IF SUBSHEDS PRESENT)	PEAK 10 - YEAR FLOW RATE AT OUTFALL (IF SUBSHEDS PRESENT)	PEAK 25 - YEAR FLOW RATE AT OUTFALL (IF SUBSHEDS PRESENT)
A 2.33	5.71	7.47	N/A	N/A	N/A
B1 1.30	4.05	5.55	2.06	5.73	7.71
B2 1.84	5.14	6.91	N/A	N/A	N/A
C 0.15	0.37	0.48	N/A	N/A	N/A
D 0.13	0.30	0.38	N/A	N/A	N/A

**STORMWATER TREATMENT REQUIREMENTS (% OF TREATED AREA)**

LAND TYPE	STATION	STATION % TREATED
IMPERVIOUS TOTAL	3.90 AC	96.15%
IMPERVIOUS TREATED	3.75 AC	
DEVELOPED TOTAL	4.87 AC	
DEVELOPED TREATED	4.18 AC	85.83%

**STORMWATER TREATMENT FOR PHOSPHOROUS STANDARD**

CONDITION	PHOSPHOROUS EXPORT LOAD (LBS P/YEAR)
PROJECT PHOSPHOROUS BUDGET	0.51
PRE-TREATMENT ALGAL AV. P EXPORT	1.65
POST-TREATMENT ALGAL AV. P EXPORT	0.45

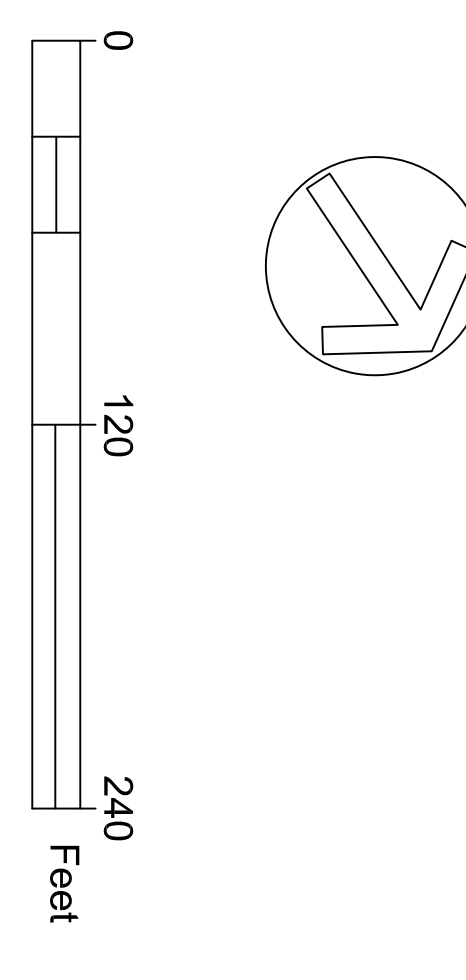

REV.	DESCRIPTION	DATE	BY	CHK	APP	OWNER ENGINEER
B	WEDEP PERMIT SET COMMENT REVISIONS	05/29/18	TJG	KRV		

REV.	DESCRIPTION	DATE	BY	CHK	APP	OWNER ENGINEER

REV.	DESCRIPTION	DATE	BY	CHK	APP	OWNER ENGINEER

REV.	DESCRIPTION	DATE	BY	CHK	APP	OWNER ENGINEER

REV.	DESCRIPTION	DATE	BY	CHK	APP	OWNER ENGINEER

**ISSUED FOR PERMITTING**  
**NOT FOR CONSTRUCTION 05/29/18**

POST-DEVELOPMENT STORMWATER PLAN

SH 3 OF 3

FICKETT ROAD/1077

POWNA, ME

1077-003-003

USA ENGINEERING  
 BERDROLA - USA



CONFIDENTIAL, PROPRIETARY AND TRADE SECRET INFORMATION



<b>Worksheet 1 - PPB calculations</b>			
<b>Project Name:</b>	<b>Fickett Road Substation</b>		
<b>Lake Watershed:</b>	<b>Runaround Pond</b>		
<b>Town:</b>	<b>Durham</b>		
<b>Standard Calculations</b>			
Watershed per acre phosphorus budget (Appendix C)	<b>PAPB</b>	0.03	lbs P/acre/year
Total acreage of development parcel:	<b>TA</b>	19.61	acres
NWI wetland acreage:	<b>WA</b>	2.41	acres
Steep slope acreage:	<b>SA</b>	0.17	acres
Project acreage: $A = TA - (WA + SA)$	<b>A</b>	17.03	acres
<b>Project Phosphorus Budget: <math>PPB = P \times A</math></b>	<b>PPB</b>	0.51	<b>lbs P/year</b>
<b>Small Watershed Adjustment</b>			
If Project Acreage (A) is greater than the threshold acreage for the small watershed threshold (SWT, from pertinent lake and town info in the table in Appendix C), calculate an alternative PPB using the analysis below and use this value if it is less than the the Standard Calculation PPB.			
Small Watershed Threshold (Appendix C):	<b>SWT</b>	N/A	acres
Project acreage:	<b>A</b>	N/A	acres
Allowable increase in town's share of annual phosphorus load to lake (Appendix C):	<b>FC</b>	N/A	lbs P/year
Area available for development (Appendix C):	<b>AAD</b>	N/A	acres
Ratio of A to AAD ( $R = A/AAD$ )	<b>R</b>	N/A	
<b>Project Phosphorus Budget</b>			
<b>If <math>R &lt; 0.5</math>, <math>PPB = [(FC \times R)/2] + [FC/4]</math></b>	<b>PPB</b>	N/A	<b>lbs P/year</b>
<b>If <math>R &gt; 0.5</math>, <math>PPB = FC \times R</math></b>	<b>PPB</b>	N/A	<b>lbs P/year</b>

## Worksheet 2

### Pre-PPE and Post-PPE Calculations

Calculate phosphorus export from development for before and after treatment  
 Use as many sheets as needed for each development type (commercial, roads, residential lots, etc.)

Project name: Fickett Substation Development type: Commercial Sheet #           

Land Surface Type or Lot #(s) with description	Acres or # of lots	Export Coefficient from Table 3.1 Table 3.2	Pre- treatment Algal Av. P Export (lbs P/year)	Treatment Factor for BMP(s) from Chapter 6	Post- treatment Algal Av. P Export (lbs P/year)	Description of BMPs
Impervious Roofs	0.24	0.5	0.12	0.1	0.01	Stone yard to Soil Filter
Stone Station Pad	1.58	0.3	0.47	0.1	0.05	Stone Yard
Concrete Foundations	0.05	0.5	0.03	0.1	0.00	Stone Yard
Stone Station Pad to Soil Filter	1.88	0.3	0.56	0.1	0.06	Stone yard to Soil Filter
Gravel Road Outside Station	0.15	0.5	0.08	1	0.08	N/A
Landscaped Treated	0.43	0.4	0.17	0.25	0.04	Soil Filter
Landscaped Untreated	0.54	0.4	0.22	1	0.22	N/A
<b>Total Pre-PPE (lbs P/year)</b>			1.65	<b>Total PostPPE (lbs P/year)</b>		0.45

## WORKSHEET 4 - PROJECT PHOSPHORUS EXPORT SUMMARY

Summarizing the project's algal available phosphorus export (PPE)

**Project Name: Fickett Road Substation**

<b>Project Phosphorus Budget - Worksheet 1</b>	<b>PPB</b>	0.51	lbs P/year
<b>Total Pre-Treatment Phosphorus Export - Worksheet 2</b>	<b>Pre-PPE</b>	1.65	lbs P/year
<b>Total Post-Treatment Phosphorus Export - Worksheet 2</b>	<b>Post-PPE</b>	0.45	lbs P/year
<b>Total Phosphorus Mitigation Credit - Worksheet 3</b>	<b>TMC</b>	0.00	lbs P/year
<b>Project Phosphorus Export (Post-PPE - TMC)</b>	<b>PPE</b>	0.45	lbs P/year

**Is the Project Phosphorus Export  $\leq$  the Project Phosphorus Budget? (PPE $\leq$ PPB)**

<p><i>If <b>YES</b>, PPE is less than or equal to PPB and the project meets its phosphorus budget.</i></p> <p><i>If <b>NO</b>, PPE is greater than PPB, more reduction in phosphorus export is required or the payment of a compensation fee may be an option</i></p>	YES
<i>The amount of phosphorus that needs further treatment or compensation</i>	lbs P/year

**Has Project Phosphorus Export been sufficiently reduced?**

*Is (Pre-PPE - Post-PPE)/Pre-PPE greater than 0.60?*

<p><i>If <b>YES</b>, in some watersheds the compensation fee is an available option.</i></p> <p><i>If <b>NO</b>, more treatment must be provided. PPE must be further reduced.</i></p>	
<i>The post-treatment phosphorus export must be less than 40% of the pre-treatment export (Post-PPE &lt; 0.4*Pre-PPE)</i>	%

**If the project is located in a watershed that is eligible for a compensation fee (or is a residential subdivision with buffers), a compensation fee may be appropriate as follows:**

<i>If Project Export has been reduced by greater than 60% and less than 75%, \$25,000 per pound minus \$833 per 1% Percent Export</i>	
<i>If Project Export has been reduced by greater than 75%, \$12,500 per pound minus \$500 per 1% Project Export</i>	

**Calculations for Grassed Underdrain Soil Filter**

\*Based upon MeDEP Stormwater BMPs Chapter 7.1 - Grassed Underdrain Soil Filters and Phosphorus Control Manual

Land Type	Area (AC.)	BMP <sub>ST</sub> = WQv Required, General Standard <sup>1</sup> , (CU.FT.)	Treatment Factor (TF) <sup>2</sup>	BMP <sub>TF</sub> = WQv Required, Phosphorus Standard + General Standard <sup>3</sup> , (CU.FT.)	WQv Required <sup>4</sup> , BMP <sub>TF</sub> - BMP <sub>ST</sub> , (CU.FT.)	Total WQv Required (Impervious and Pervious) (CU.FT.)	WQv Provided <sup>5</sup> @ 18" Depth, (CU.FT.)
Impervious Catchment	2.07	7,514.10	0.25	12,022.56	4,508.46	5,507.44	8,354.00
Pervious Developed Catchment	0.43	624.36	0.25	998.98	998.98		

<sup>1</sup> The General Standard has been met by providing the required BMP<sub>ST</sub> Water Quality volume within the MeDEP approved station pad stone section.

<sup>2</sup> The Treatment Factor used to upsize the required Standard Treatment volume in order to meet the Phosphorous Standard.

<sup>3</sup> The Water Quality volume required to meet the General and Phosphorous Standards, calculated using the Maine Storm Water Management Design Manual - Phosphorus Control Manual, Section 4.3:  $BMP_{TF} = 0.4 * (BMP_{ST} / TF)$

<sup>4</sup> The Water Quality volume required to meet the Phosphorous Standard for areas where the General Standard has already been met within the MeDEP approved station pad stone section.

<sup>5</sup> Flow rate for ball valve to detain WQv over 36 hour period =  $8,354 CF * 7.48 GAL / CF / (36 HR * 60 MIN / HR) = 29 GPM$ . Flow rate ranges between 22 - 43 GPM for detention times between 24 - 48 HR.

**Orifice Sizing, Ball Valve**

WQv Required (CF)	Detention Time (HR)	Flow Rate (CFS)	Average Head (FT)	Orifice Coefficient	Orifice Area (SF)	Orifice Diameter (IN) <sup>3</sup>
8354	36	0.064459877	1.96	0.614	0.009344372	1.308914774

<sup>3</sup> Equivalent Ball Valve Opening = 1/4 Turn

# Culvert Report

## Circular Culvert

Invert Elev Dn (ft)	= 180.55
Pipe Length (ft)	= 45.00
Slope (%)	= 1.00
Invert Elev Up (ft)	= 181.00
Rise (in)	= 15.0
Shape	= Circular
Span (in)	= 15.0
No. Barrels	= 1
n-Value	= 0.015
Culvert Type	= Circular Concrete
Culvert Entrance	= Groove end projecting (C)
Coeff. K,M,c,Y,k	= 0.0045, 2, 0.0317, 0.69, 0.2

### Embankment

Top Elevation (ft)	= 184.00
Top Width (ft)	= 22.00
Crest Width (ft)	= 20.00

### Calculations

Qmin (cfs)	= 2.03
Qmax (cfs)	= 2.03
Tailwater Elev (ft)	= (dc+D)/2

### Highlighted

Qtotal (cfs)	= 2.03
Qpipe (cfs)	= 2.03
Qovertop (cfs)	= 0.00
Veloc Dn (ft/s)	= 2.12
Veloc Up (ft/s)	= 3.75
HGL Dn (ft)	= 181.46
HGL Up (ft)	= 181.57
Hw Elev (ft)	= 181.79
Hw/D (ft)	= 0.63
Flow Regime	= Inlet Control

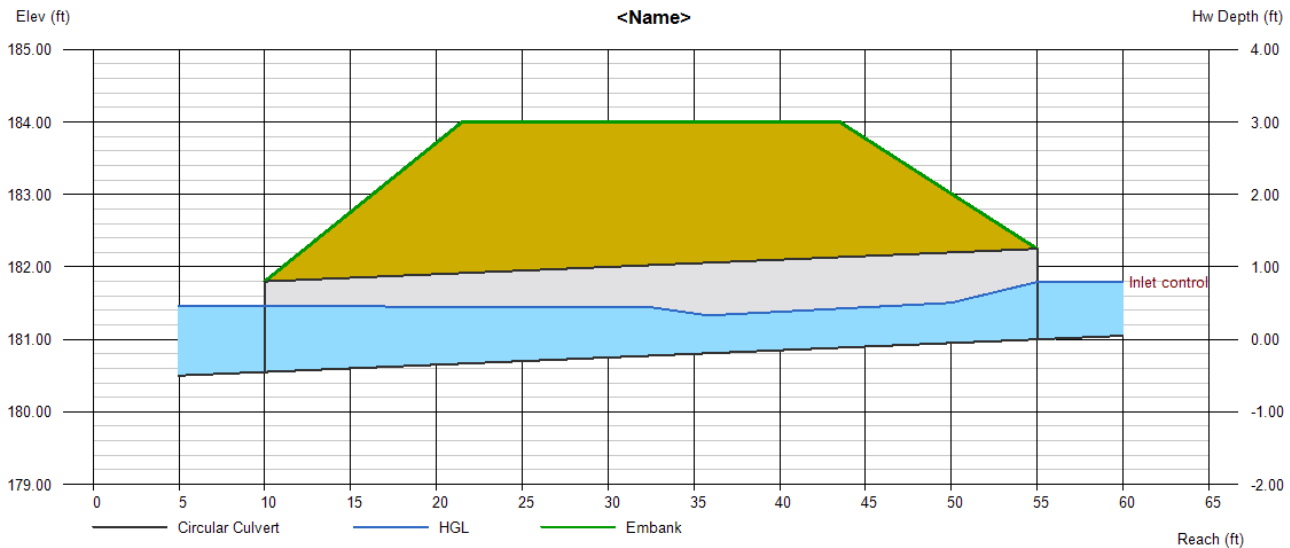



## Project Description

File Name ..... Existing Conditions.SPF

## Project Options

Flow Units ..... CFS  
 Elevation Type ..... Elevation  
 Hydrology Method ..... SCS TR-55  
 Time of Concentration (TOC) Method ..... SCS TR-55  
 Link Routing Method ..... Kinematic Wave  
 Enable Overflow Ponding at Nodes ..... YES  
 Skip Steady State Analysis Time Periods ..... NO

## Analysis Options

Start Analysis On ..... Aug 10, 2017 00:00:00  
 End Analysis On ..... Aug 11, 2017 00:00:00  
 Start Reporting On ..... Aug 10, 2017 00:00:00  
 Antecedent Dry Days ..... 0 days  
 Runoff (Dry Weather) Time Step ..... 0 01:00:00 days hh:mm:ss  
 Runoff (Wet Weather) Time Step ..... 0 00:05:00 days hh:mm:ss  
 Reporting Time Step ..... 0 00:05:00 days hh:mm:ss  
 Routing Time Step ..... 30 seconds

## Number of Elements

	Qty
Rain Gages .....	1
Subbasins.....	4
Nodes.....	4
<i>Junctions</i> .....	0
<i>Outfalls</i> .....	4
<i>Flow Diversions</i> .....	0
<i>Inlets</i> .....	0
<i>Storage Nodes</i> .....	0
Links.....	0
<i>Channels</i> .....	0
<i>Pipes</i> .....	0
<i>Pumps</i> .....	0
<i>Orifices</i> .....	0
<i>Weirs</i> .....	0
<i>Outlets</i> .....	0
Pollutants .....	0
Land Uses .....	0

## Rainfall Details

SN	Rain Gage ID	Data Source	Data Source ID	Rainfall Type	Rain Units	State	County	Return Period (years)	Rainfall Depth (inches)	Rainfall Distribution
1	Rain Gage-01	Time Series	TS-02	Cumulative	inches	Maine	Cumberland (Southeast)	2	3.00	SCS Type III 24-hr

## Subbasin Summary

Subbasin ID	Area (ac)	Weighted Curve Number	Total Rainfall (in)	Total Runoff (in)	Total Runoff Volume (ac-in)	Peak Runoff (cfs)	Time of Concentration (days hh:mm:ss)
A	3.70	73.41	3.00	0.88	3.25	2.25	0 00:23:04
B	8.76	73.22	3.00	0.87	7.61	3.98	0 00:43:24
C	0.35	74.60	3.00	0.94	0.33	0.27	0 00:15:12
D	0.12	77.00	3.00	1.07	0.13	0.13	0 00:06:30

## Subbasin Hydrology

### Subbasin : A

#### Input Data

Area (ac) ..... 3.70  
 Weighted Curve Number ..... 73.41  
 Rain Gage ID ..... Rain Gage-01

#### Composite Curve Number

Soil/Surface Description	Area (acres)	Soil Group	Curve Number
Woods, Good	0.38	D	77.00
Brush, Good	3.32	D	73.00
Composite Area & Weighted CN	3.70		73.41

#### Time of Concentration

TOC Method : SCS TR-55

Sheet Flow Equation :

$$T_c = (0.007 * ((n * L_f)^{0.8}) / ((P^{0.5}) * (S_f^{0.4})))$$

Where :

T<sub>c</sub> = Time of Concentration (hr)  
 n = Manning's roughness  
 L<sub>f</sub> = Flow Length (ft)  
 P = 2 yr, 24 hr Rainfall (inches)  
 S<sub>f</sub> = Slope (ft/ft)

Shallow Concentrated Flow Equation :

V = 16.1345 \* (S<sub>f</sub><sup>0.5</sup>) (unpaved surface)  
 V = 20.3282 \* (S<sub>f</sub><sup>0.5</sup>) (paved surface)  
 V = 15.0 \* (S<sub>f</sub><sup>0.5</sup>) (grassed waterway surface)  
 V = 10.0 \* (S<sub>f</sub><sup>0.5</sup>) (nearly bare & untilled surface)  
 V = 9.0 \* (S<sub>f</sub><sup>0.5</sup>) (cultivated straight rows surface)  
 V = 7.0 \* (S<sub>f</sub><sup>0.5</sup>) (short grass pasture surface)  
 V = 5.0 \* (S<sub>f</sub><sup>0.5</sup>) (woodland surface)  
 V = 2.5 \* (S<sub>f</sub><sup>0.5</sup>) (forest w/heavy litter surface)  
 T<sub>c</sub> = (L<sub>f</sub> / V) / (3600 sec/hr)

Where:

T<sub>c</sub> = Time of Concentration (hr)  
 L<sub>f</sub> = Flow Length (ft)  
 V = Velocity (ft/sec)  
 S<sub>f</sub> = Slope (ft/ft)

Channel Flow Equation :

V = (1.49 \* (R<sup>2/3</sup>) \* (S<sub>f</sub><sup>0.5</sup>)) / n  
 R = A<sub>q</sub> / W<sub>p</sub>  
 T<sub>c</sub> = (L<sub>f</sub> / V) / (3600 sec/hr)

Where :

T<sub>c</sub> = Time of Concentration (hr)  
 L<sub>f</sub> = Flow Length (ft)  
 R = Hydraulic Radius (ft)  
 A<sub>q</sub> = Flow Area (ft<sup>2</sup>)  
 W<sub>p</sub> = Wetted Perimeter (ft)  
 V = Velocity (ft/sec)  
 S<sub>f</sub> = Slope (ft/ft)  
 n = Manning's roughness

	Subarea	Subarea	Subarea
	A	B	C
<b>Sheet Flow Computations</b>			
Manning's Roughness :	.6	0.00	0.00
Flow Length (ft) :	100	0.00	0.00
Slope (%) :	14.36	0.00	0.00
2 yr, 24 hr Rainfall (in) :	3.00	0.00	0.00
Velocity (ft/sec) :	0.12	0.00	0.00
Computed Flow Time (min) :	13.94	0.00	0.00
<b>Shallow Concentrated Flow Computations</b>			
	Subarea	Subarea	Subarea
	A	B	C
Flow Length (ft) :	625	0.00	0.00
Slope (%) :	.582	0.00	0.00
Surface Type :	Grassed waterway	Unpaved	Unpaved
Velocity (ft/sec) :	1.14	0.00	0.00
Computed Flow Time (min) :	9.14	0.00	0.00
Total TOC (min) .....	23.08		

**Subbasin Runoff Results**

Total Rainfall (in) .....	3.00
Total Runoff (in) .....	0.88
Peak Runoff (cfs) .....	2.25
Weighted Curve Number .....	73.41
Time of Concentration (days hh:mm:ss) .....	0 00:23:05

Subbasin : A

Rainfall Intensity Graph

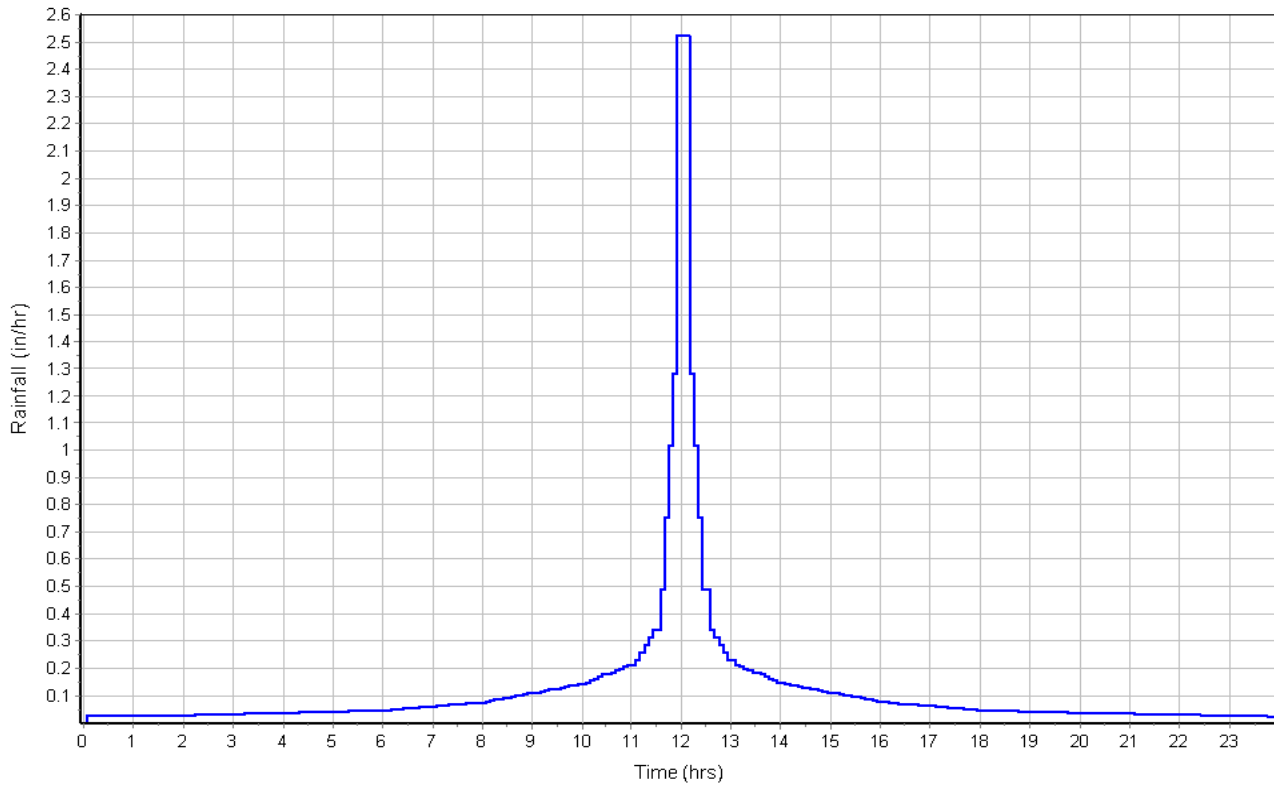

Runoff Hydrograph

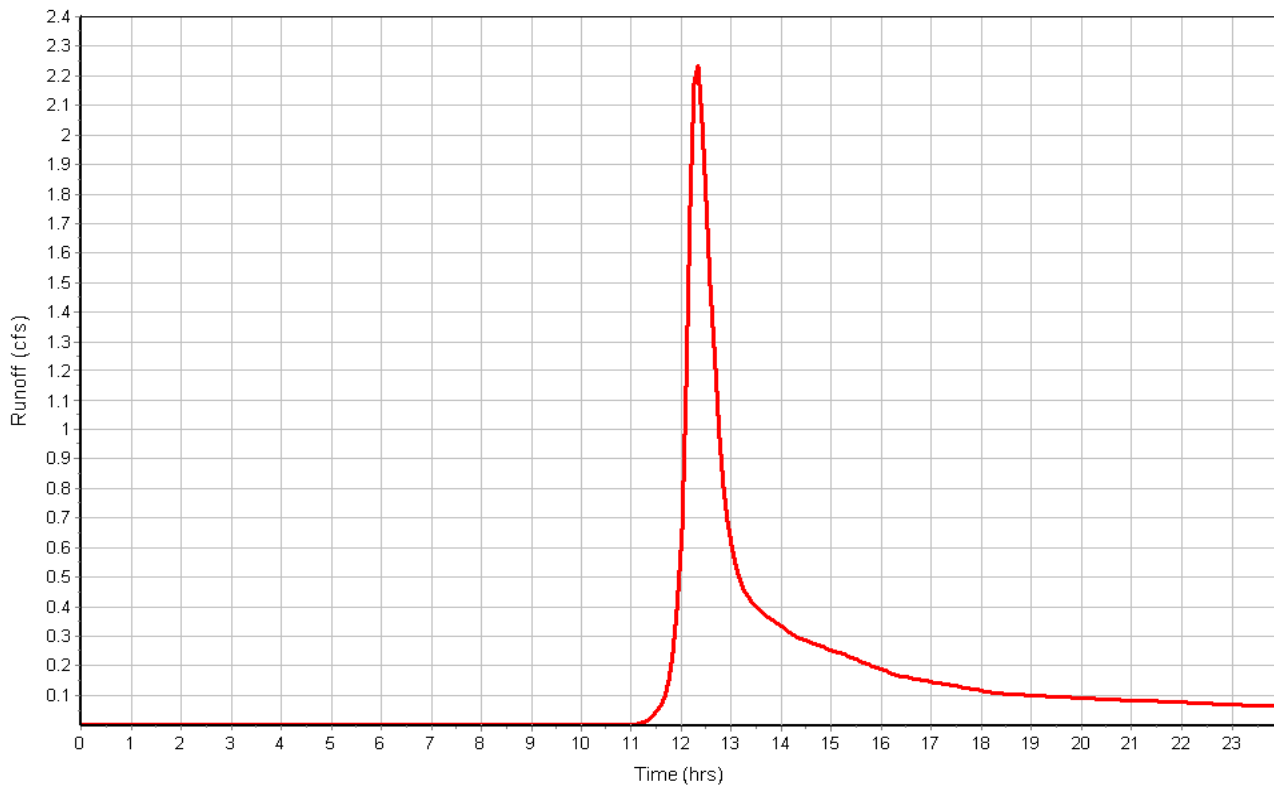

**Subbasin : B**

**Input Data**

Area (ac) ..... 8.76  
 Weighted Curve Number ..... 73.22  
 Rain Gage ID ..... Rain Gage-01

**Composite Curve Number**

Soil/Surface Description	Area (acres)	Soil Group	Curve Number
Brush, Good	8.27	D	73.00
Woods, Good	0.49	D	77.00
Composite Area & Weighted CN	8.76		73.22

**Time of Concentration**

Sheet Flow Computations	Subarea	Subarea	Subarea
	A	B	C
Manning's Roughness :	.6	0.00	0.00
Flow Length (ft) :	100	0.00	0.00
Slope (%) :	4.25	0.00	0.00
2 yr, 24 hr Rainfall (in) :	3.00	0.00	0.00
Velocity (ft/sec) :	0.07	0.00	0.00
Computed Flow Time (min) :	22.69	0.00	0.00

Shallow Concentrated Flow Computations	Subarea	Subarea	Subarea
	A	B	C
Flow Length (ft) :	758	0.00	0.00
Slope (%) :	.758	0.00	0.00
Surface Type :	Grass pasture	Unpaved	Unpaved
Velocity (ft/sec) :	0.61	0.00	0.00
Computed Flow Time (min) :	20.71	0.00	0.00
Total TOC (min) .....	43.40		

**Subbasin Runoff Results**

Total Rainfall (in) ..... 3.00  
 Total Runoff (in) ..... 0.87  
 Peak Runoff (cfs) ..... 3.98  
 Weighted Curve Number ..... 73.22  
 Time of Concentration (days hh:mm:ss) ..... 0 00:43:24

**Subbasin : B**

**Rainfall Intensity Graph**

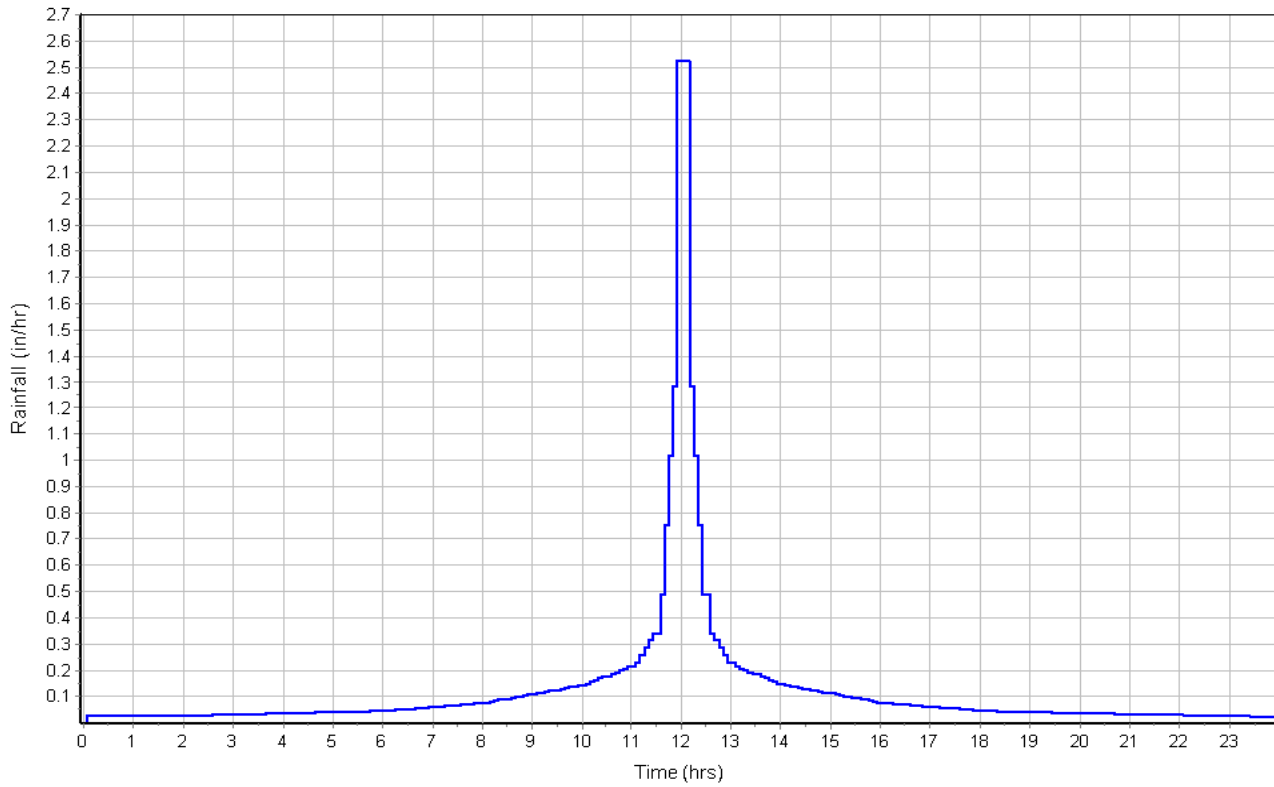

**Runoff Hydrograph**

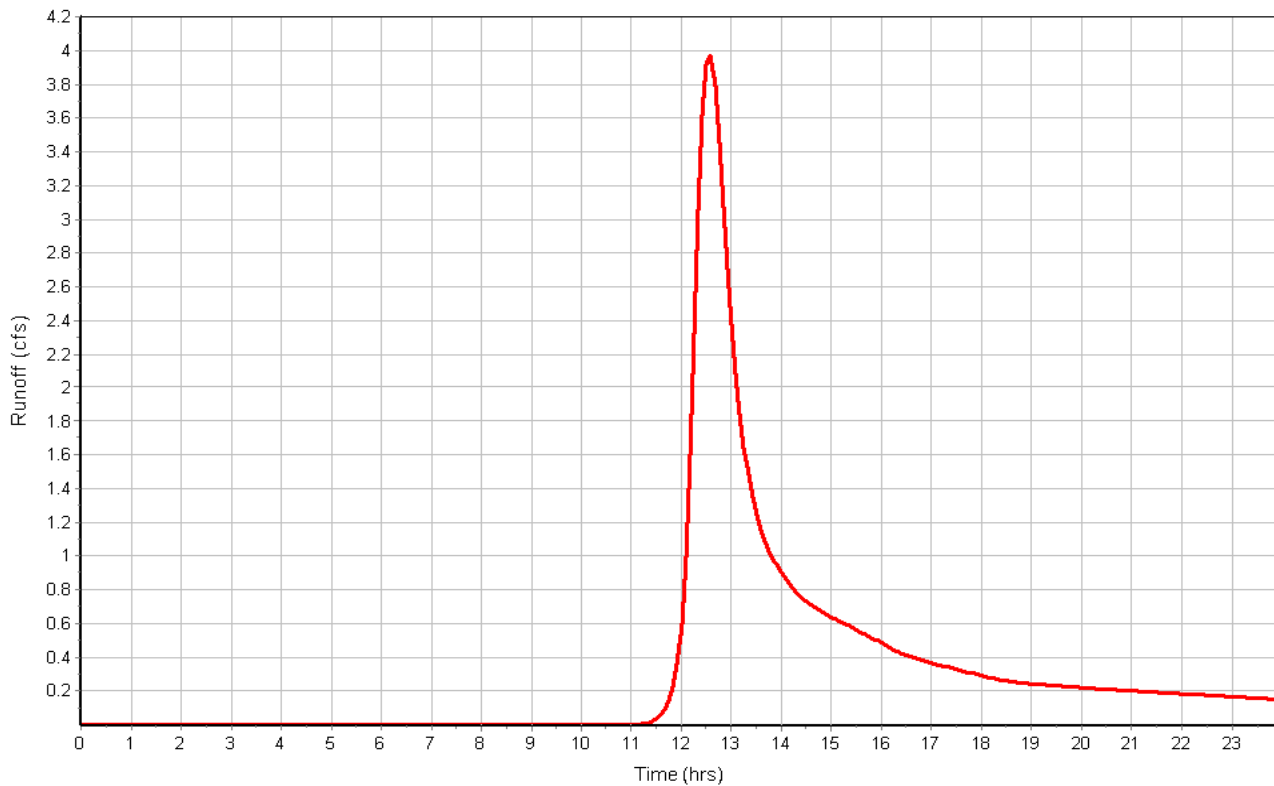

**Subbasin : C**

**Input Data**

Area (ac) ..... 0.35  
 Weighted Curve Number ..... 74.60  
 Rain Gage ID ..... Rain Gage-01

**Composite Curve Number**

Soil/Surface Description	Area (acres)	Soil Group	Curve Number
Woods, Good	0.03	D	77.00
Woods, Good	0.04	D	77.00
Brush, Good	0.08	D	73.00
Brush, Good	0.13	D	73.00
Woods, Good	0.07	D	77.00
Composite Area & Weighted CN	0.35		74.60

**Time of Concentration**

	Subarea	Subarea	Subarea
	A	B	C
Sheet Flow Computations			
Manning's Roughness :	.4	0.00	0.00
Flow Length (ft) :	87	0.00	0.00
Slope (%) :	10.35	0.00	0.00
2 yr, 24 hr Rainfall (in) :	3.00	0.00	0.00
Velocity (ft/sec) :	0.14	0.00	0.00
Computed Flow Time (min) :	10.28	0.00	0.00
Shallow Concentrated Flow Computations			
Flow Length (ft) :	313	0.00	0.00
Slope (%) :	2.3	0.00	0.00
Surface Type :	Grass pasture	Unpaved	Unpaved
Velocity (ft/sec) :	1.06	0.00	0.00
Computed Flow Time (min) :	4.92	0.00	0.00
Total TOC (min) .....	15.20		

**Subbasin Runoff Results**

Total Rainfall (in) ..... 3.00  
 Total Runoff (in) ..... 0.94  
 Peak Runoff (cfs) ..... 0.27  
 Weighted Curve Number ..... 74.60  
 Time of Concentration (days hh:mm:ss) ..... 0 00:15:12



Subbasin : C

Rainfall Intensity Graph

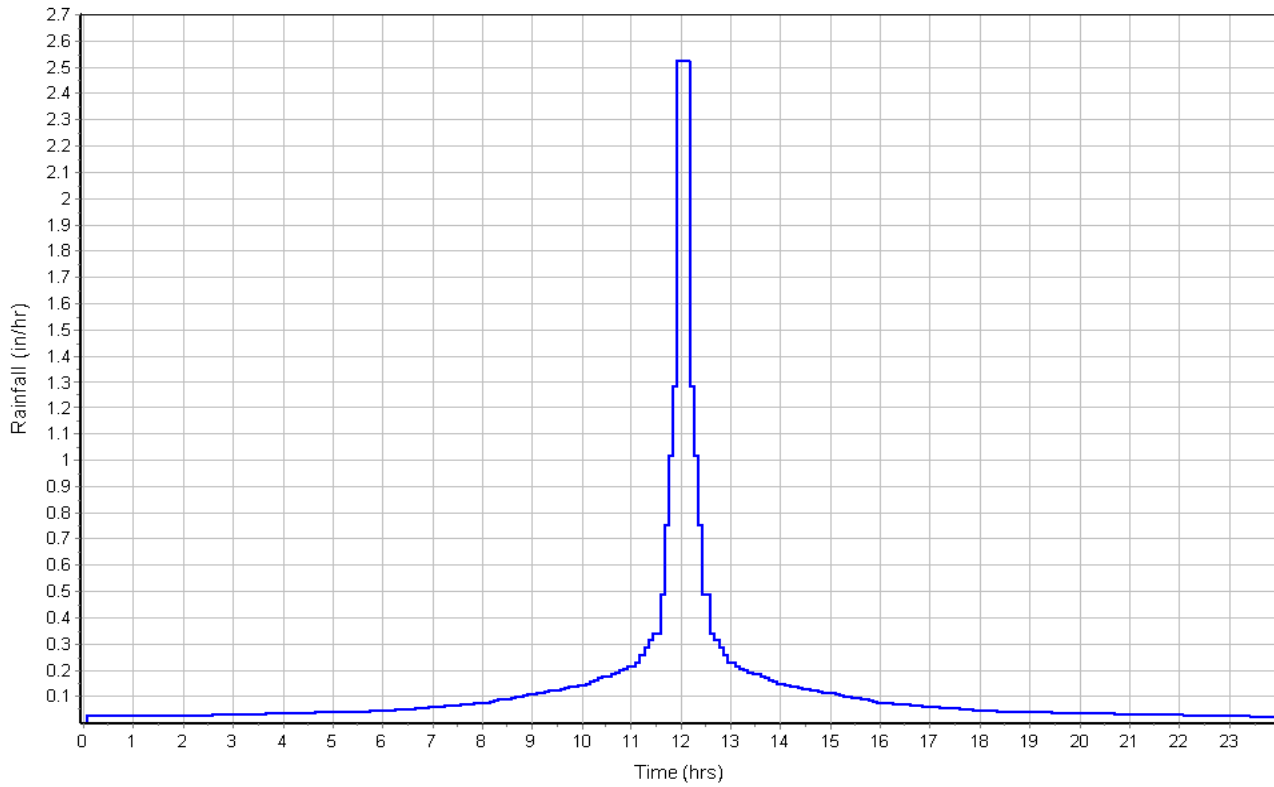

Runoff Hydrograph

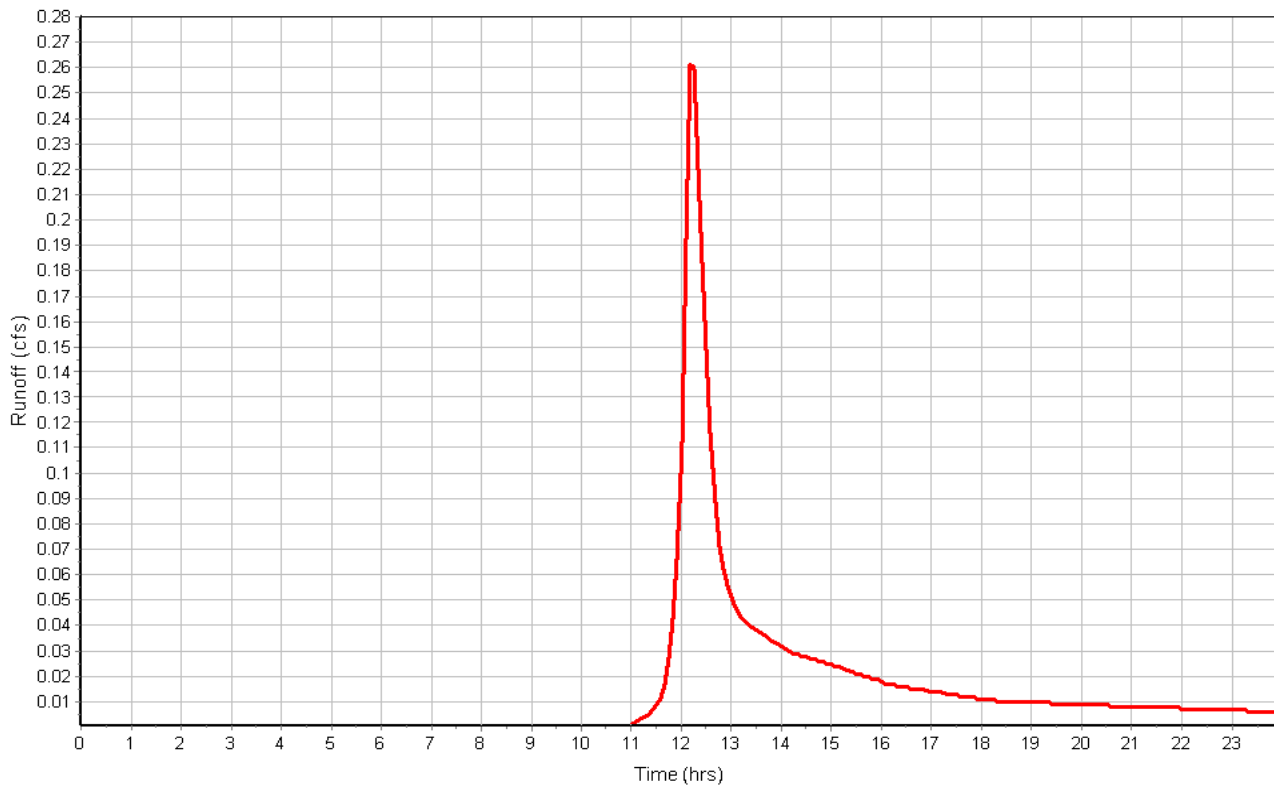

**Subbasin : D**

**Input Data**

Area (ac) ..... 0.12  
 Weighted Curve Number ..... 77.00  
 Rain Gage ID ..... Rain Gage-01

**Composite Curve Number**

Soil/Surface Description	Area (acres)	Soil Group	Curve Number
Woods, Good	0.12	D	77.00
Composite Area & Weighted CN	0.12		77.00

**Time of Concentration**

Sheet Flow Computations	Subarea	Subarea	Subarea
	A	B	C
Manning's Roughness :	.4	0.00	0.00
Flow Length (ft) :	36	0.00	0.00
Slope (%) :	5.55	0.00	0.00
2 yr, 24 hr Rainfall (in) :	3.00	0.00	0.00
Velocity (ft/sec) :	0.09	0.00	0.00
Computed Flow Time (min) :	6.51	0.00	0.00
Total TOC (min) .....	6.51		

**Subbasin Runoff Results**

Total Rainfall (in) ..... 3.00  
 Total Runoff (in) ..... 1.07  
 Peak Runoff (cfs) ..... 0.13  
 Weighted Curve Number ..... 77.00  
 Time of Concentration (days hh:mm:ss) ..... 0 00:06:31

Subbasin : D

Rainfall Intensity Graph

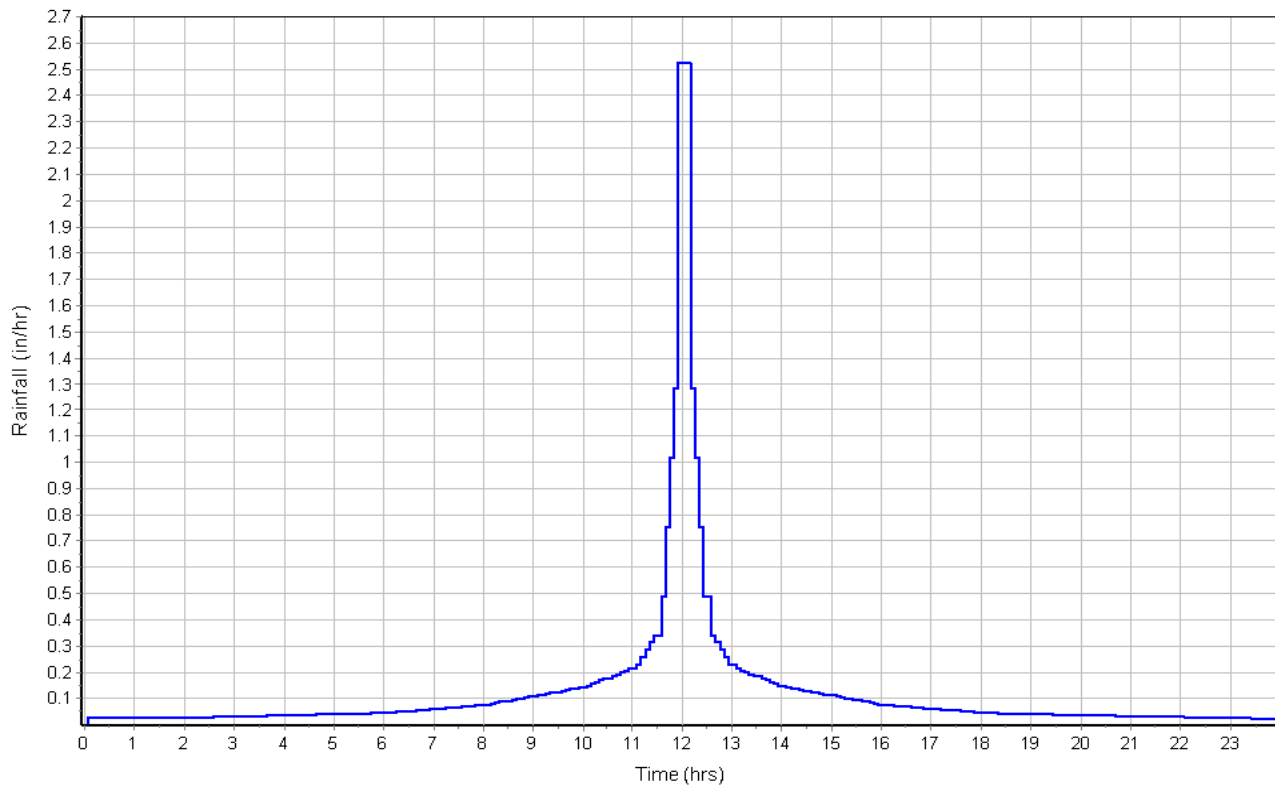

Runoff Hydrograph

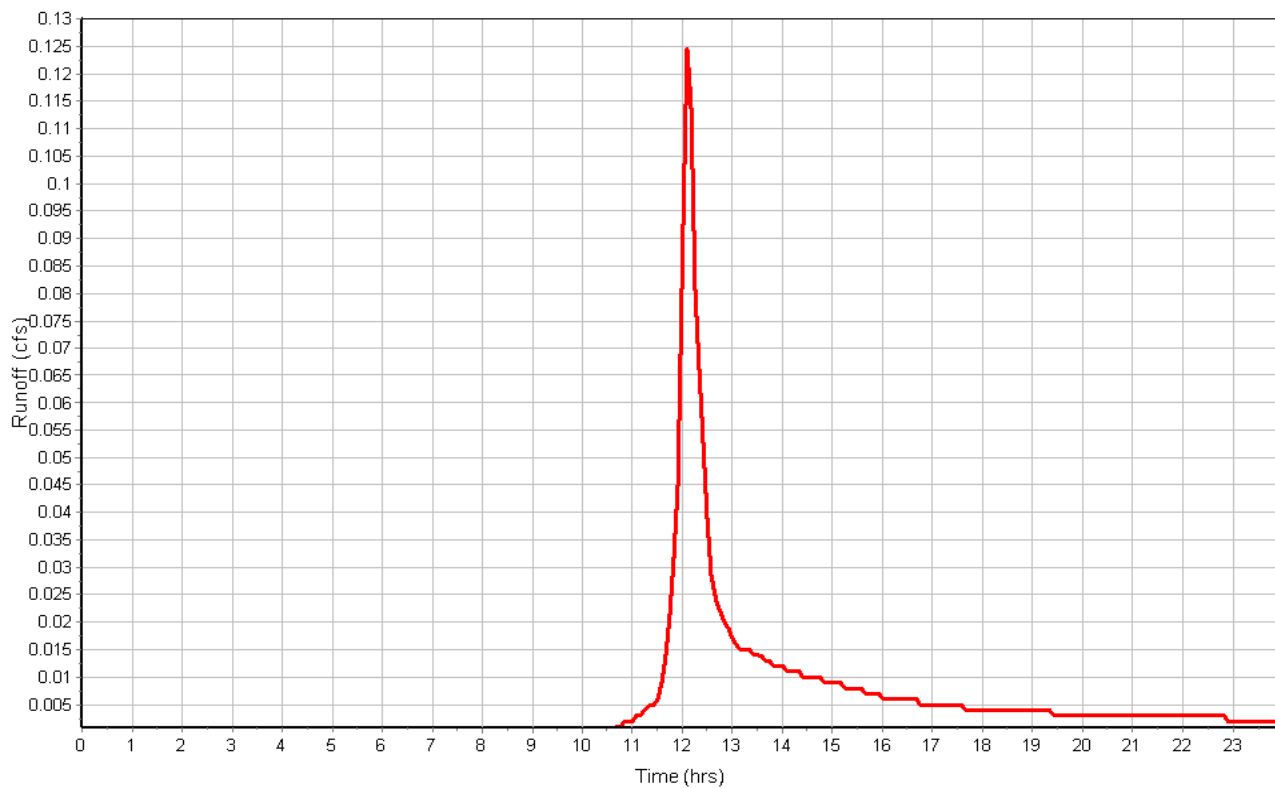

## Project Description

File Name ..... Existing Conditions.SPF

## Project Options

Flow Units ..... CFS  
 Elevation Type ..... Elevation  
 Hydrology Method ..... SCS TR-55  
 Time of Concentration (TOC) Method ..... SCS TR-55  
 Link Routing Method ..... Kinematic Wave  
 Enable Overflow Ponding at Nodes ..... YES  
 Skip Steady State Analysis Time Periods ..... NO

## Analysis Options

Start Analysis On ..... Aug 10, 2017 00:00:00  
 End Analysis On ..... Aug 11, 2017 00:00:00  
 Start Reporting On ..... Aug 10, 2017 00:00:00  
 Antecedent Dry Days ..... 0 days  
 Runoff (Dry Weather) Time Step ..... 0 01:00:00 days hh:mm:ss  
 Runoff (Wet Weather) Time Step ..... 0 00:05:00 days hh:mm:ss  
 Reporting Time Step ..... 0 00:05:00 days hh:mm:ss  
 Routing Time Step ..... 30 seconds

## Number of Elements

	Qty
Rain Gages .....	1
Subbasins.....	4
Nodes.....	4
<i>Junctions</i> .....	0
<i>Outfalls</i> .....	4
<i>Flow Diversions</i> .....	0
<i>Inlets</i> .....	0
<i>Storage Nodes</i> .....	0
Links.....	0
<i>Channels</i> .....	0
<i>Pipes</i> .....	0
<i>Pumps</i> .....	0
<i>Orifices</i> .....	0
<i>Weirs</i> .....	0
<i>Outlets</i> .....	0
Pollutants .....	0
Land Uses .....	0

## Rainfall Details

SN	Rain Gage ID	Data Source	Data Source ID	Rainfall Type	Rain Units	State	County	Return Period (years)	Rainfall Depth (inches)	Rainfall Distribution
1	Rain Gage-01	Time Series	TS-10	Cumulative	inches	Maine	Cumberland (Southeast)	10	4.70	SCS Type III 24-hr

## Subbasin Summary

Subbasin ID	Area (ac)	Weighted Curve Number	Total Rainfall (in)	Total Runoff (in)	Total Runoff Volume (ac-in)	Peak Runoff (cfs)	Time of Concentration (days hh:mm:ss)
A	3.70	73.41	4.70	2.08	7.70	5.70	0 00:23:04
B	8.76	73.22	4.70	2.07	18.10	10.12	0 00:43:24
C	0.35	74.60	4.70	2.18	0.76	0.66	0 00:15:12
D	0.12	77.00	4.70	2.37	0.28	0.30	0 00:06:30

## Subbasin Hydrology

### Subbasin : A

#### Input Data

Area (ac) ..... 3.70  
 Weighted Curve Number ..... 73.41  
 Rain Gage ID ..... Rain Gage-01

#### Composite Curve Number

Soil/Surface Description	Area (acres)	Soil Group	Curve Number
Woods, Good	0.38	D	77.00
Brush, Good	3.32	D	73.00
Composite Area & Weighted CN	3.70		73.41

#### Time of Concentration

TOC Method : SCS TR-55

Sheet Flow Equation :

$$T_c = (0.007 * ((n * L_f)^{0.8}) / ((P^{0.5}) * (S_f^{0.4})))$$

Where :

T<sub>c</sub> = Time of Concentration (hr)  
 n = Manning's roughness  
 L<sub>f</sub> = Flow Length (ft)  
 P = 2 yr, 24 hr Rainfall (inches)  
 S<sub>f</sub> = Slope (ft/ft)

Shallow Concentrated Flow Equation :

V = 16.1345 \* (S<sub>f</sub><sup>0.5</sup>) (unpaved surface)  
 V = 20.3282 \* (S<sub>f</sub><sup>0.5</sup>) (paved surface)  
 V = 15.0 \* (S<sub>f</sub><sup>0.5</sup>) (grassed waterway surface)  
 V = 10.0 \* (S<sub>f</sub><sup>0.5</sup>) (nearly bare & untilled surface)  
 V = 9.0 \* (S<sub>f</sub><sup>0.5</sup>) (cultivated straight rows surface)  
 V = 7.0 \* (S<sub>f</sub><sup>0.5</sup>) (short grass pasture surface)  
 V = 5.0 \* (S<sub>f</sub><sup>0.5</sup>) (woodland surface)  
 V = 2.5 \* (S<sub>f</sub><sup>0.5</sup>) (forest w/heavy litter surface)  
 T<sub>c</sub> = (L<sub>f</sub> / V) / (3600 sec/hr)

Where:

T<sub>c</sub> = Time of Concentration (hr)  
 L<sub>f</sub> = Flow Length (ft)  
 V = Velocity (ft/sec)  
 S<sub>f</sub> = Slope (ft/ft)

Channel Flow Equation :

V = (1.49 \* (R<sup>2/3</sup>) \* (S<sub>f</sub><sup>0.5</sup>)) / n  
 R = A<sub>q</sub> / W<sub>p</sub>  
 T<sub>c</sub> = (L<sub>f</sub> / V) / (3600 sec/hr)

Where :

T<sub>c</sub> = Time of Concentration (hr)  
 L<sub>f</sub> = Flow Length (ft)  
 R = Hydraulic Radius (ft)  
 A<sub>q</sub> = Flow Area (ft<sup>2</sup>)  
 W<sub>p</sub> = Wetted Perimeter (ft)  
 V = Velocity (ft/sec)  
 S<sub>f</sub> = Slope (ft/ft)  
 n = Manning's roughness

	Subarea	Subarea	Subarea
	A	B	C
<b>Sheet Flow Computations</b>			
Manning's Roughness :	.6	0.00	0.00
Flow Length (ft) :	100	0.00	0.00
Slope (%) :	14.36	0.00	0.00
2 yr, 24 hr Rainfall (in) :	3.00	0.00	0.00
Velocity (ft/sec) :	0.12	0.00	0.00
Computed Flow Time (min) :	13.94	0.00	0.00
<b>Shallow Concentrated Flow Computations</b>			
	Subarea	Subarea	Subarea
	A	B	C
Flow Length (ft) :	625	0.00	0.00
Slope (%) :	.582	0.00	0.00
Surface Type :	Grassed waterway	Unpaved	Unpaved
Velocity (ft/sec) :	1.14	0.00	0.00
Computed Flow Time (min) :	9.14	0.00	0.00
Total TOC (min) .....	23.08		

**Subbasin Runoff Results**

Total Rainfall (in) .....	4.70
Total Runoff (in) .....	2.08
Peak Runoff (cfs) .....	5.70
Weighted Curve Number .....	73.41
Time of Concentration (days hh:mm:ss) .....	0 00:23:05

Subbasin : A

Rainfall Intensity Graph

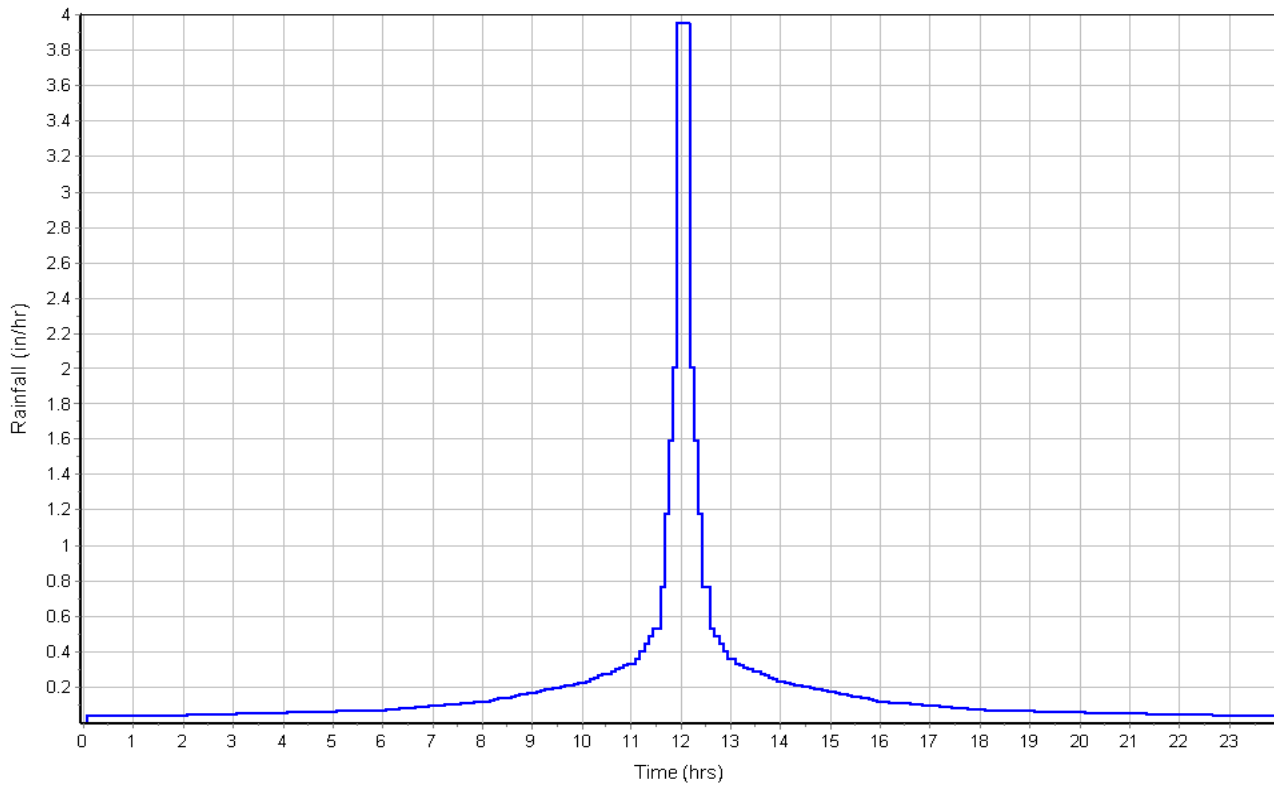

Runoff Hydrograph

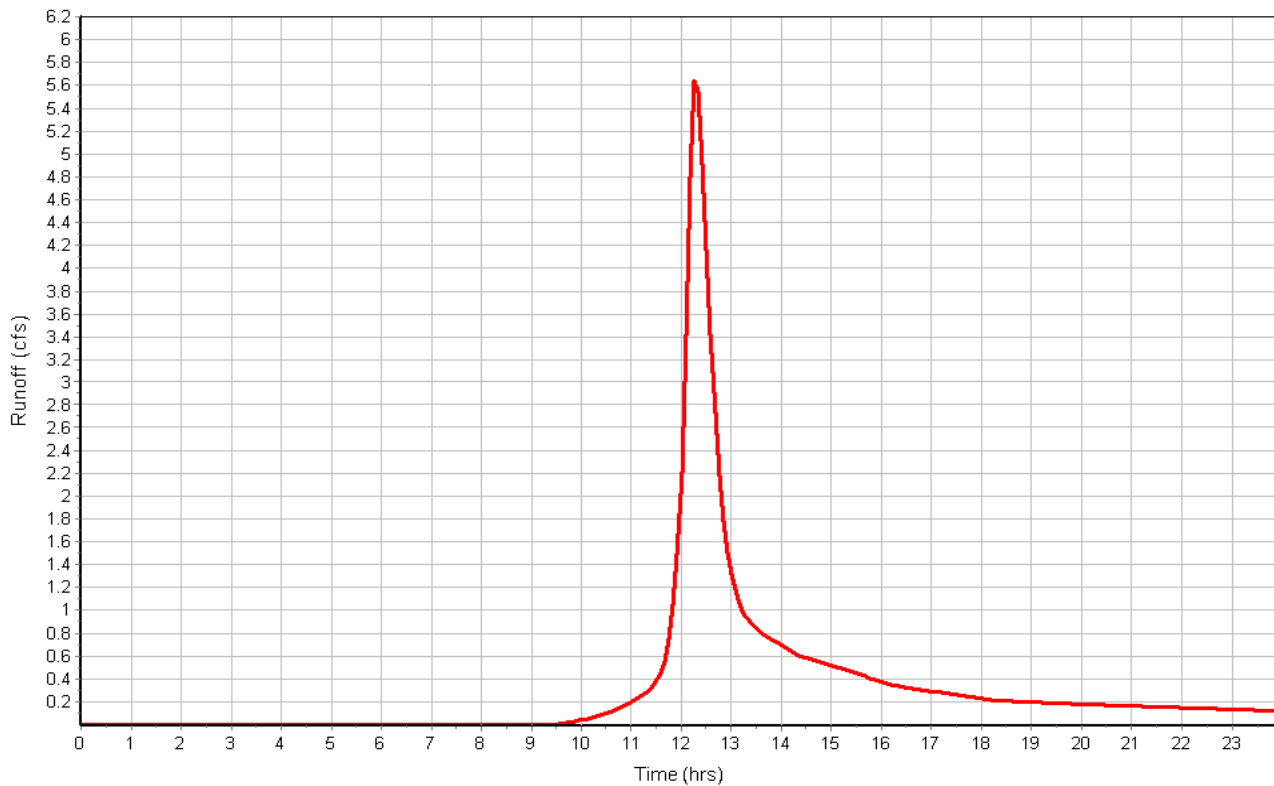



**Subbasin : B**

**Input Data**

Area (ac) ..... 8.76  
 Weighted Curve Number ..... 73.22  
 Rain Gage ID ..... Rain Gage-01

**Composite Curve Number**

Soil/Surface Description	Area (acres)	Soil Group	Curve Number
Brush, Good	8.27	D	73.00
Woods, Good	0.49	D	77.00
Composite Area & Weighted CN	8.76		73.22

**Time of Concentration**

Sheet Flow Computations	Subarea	Subarea	Subarea
	A	B	C
Manning's Roughness :	.6	0.00	0.00
Flow Length (ft) :	100	0.00	0.00
Slope (%) :	4.25	0.00	0.00
2 yr, 24 hr Rainfall (in) :	3.00	0.00	0.00
Velocity (ft/sec) :	0.07	0.00	0.00
Computed Flow Time (min) :	22.69	0.00	0.00

Shallow Concentrated Flow Computations	Subarea	Subarea	Subarea
	A	B	C
Flow Length (ft) :	758	0.00	0.00
Slope (%) :	.758	0.00	0.00
Surface Type :	Grass pasture	Unpaved	Unpaved
Velocity (ft/sec) :	0.61	0.00	0.00
Computed Flow Time (min) :	20.71	0.00	0.00
Total TOC (min) .....	43.40		

**Subbasin Runoff Results**

Total Rainfall (in) ..... 4.70  
 Total Runoff (in) ..... 2.07  
 Peak Runoff (cfs) ..... 10.12  
 Weighted Curve Number ..... 73.22  
 Time of Concentration (days hh:mm:ss) ..... 0 00:43:24

**Subbasin : B**

**Rainfall Intensity Graph**

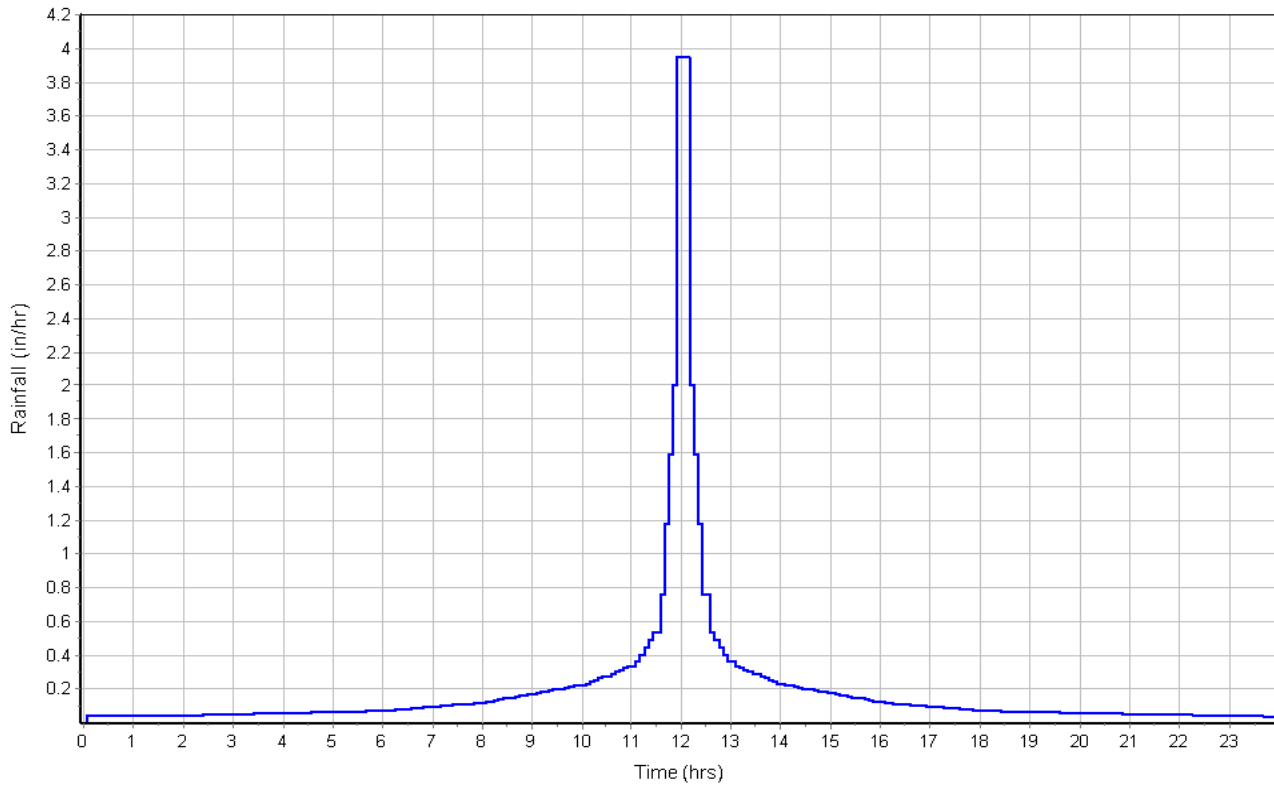

**Runoff Hydrograph**

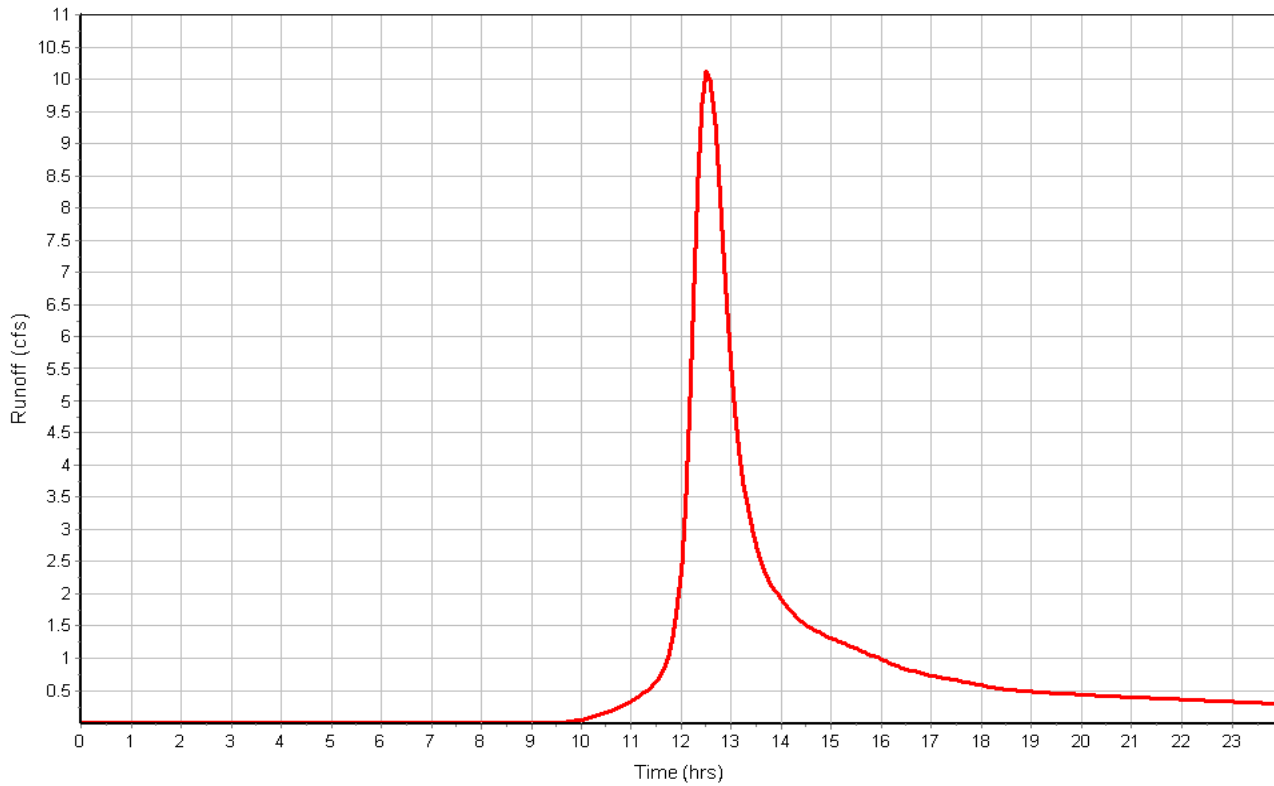

**Subbasin : C**

**Input Data**

Area (ac) ..... 0.35  
 Weighted Curve Number ..... 74.60  
 Rain Gage ID ..... Rain Gage-01

**Composite Curve Number**

Soil/Surface Description	Area (acres)	Soil Group	Curve Number
Woods, Good	0.03	D	77.00
Woods, Good	0.04	D	77.00
Brush, Good	0.08	D	73.00
Brush, Good	0.13	D	73.00
Woods, Good	0.07	D	77.00
Composite Area & Weighted CN	0.35		74.60

**Time of Concentration**

	Subarea	Subarea	Subarea
	A	B	C
Sheet Flow Computations			
Manning's Roughness :	.4	0.00	0.00
Flow Length (ft) :	87	0.00	0.00
Slope (%) :	10.35	0.00	0.00
2 yr, 24 hr Rainfall (in) :	3.00	0.00	0.00
Velocity (ft/sec) :	0.14	0.00	0.00
Computed Flow Time (min) :	10.28	0.00	0.00
Shallow Concentrated Flow Computations			
Flow Length (ft) :	313	0.00	0.00
Slope (%) :	2.3	0.00	0.00
Surface Type :	Grass pasture	Unpaved	Unpaved
Velocity (ft/sec) :	1.06	0.00	0.00
Computed Flow Time (min) :	4.92	0.00	0.00
Total TOC (min) .....	15.20		

**Subbasin Runoff Results**

Total Rainfall (in) ..... 4.70  
 Total Runoff (in) ..... 2.18  
 Peak Runoff (cfs) ..... 0.66  
 Weighted Curve Number ..... 74.60  
 Time of Concentration (days hh:mm:ss) ..... 0 00:15:12

**Subbasin : C**

**Rainfall Intensity Graph**

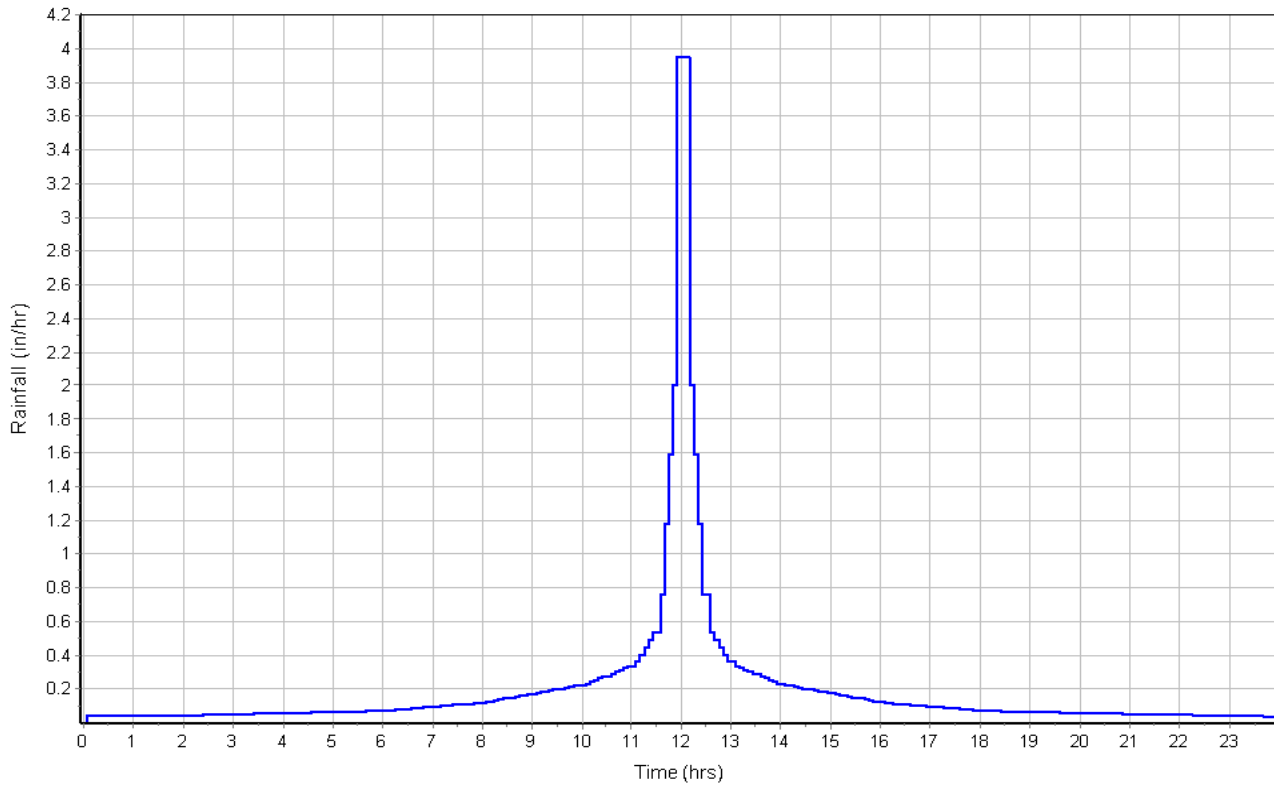

**Runoff Hydrograph**

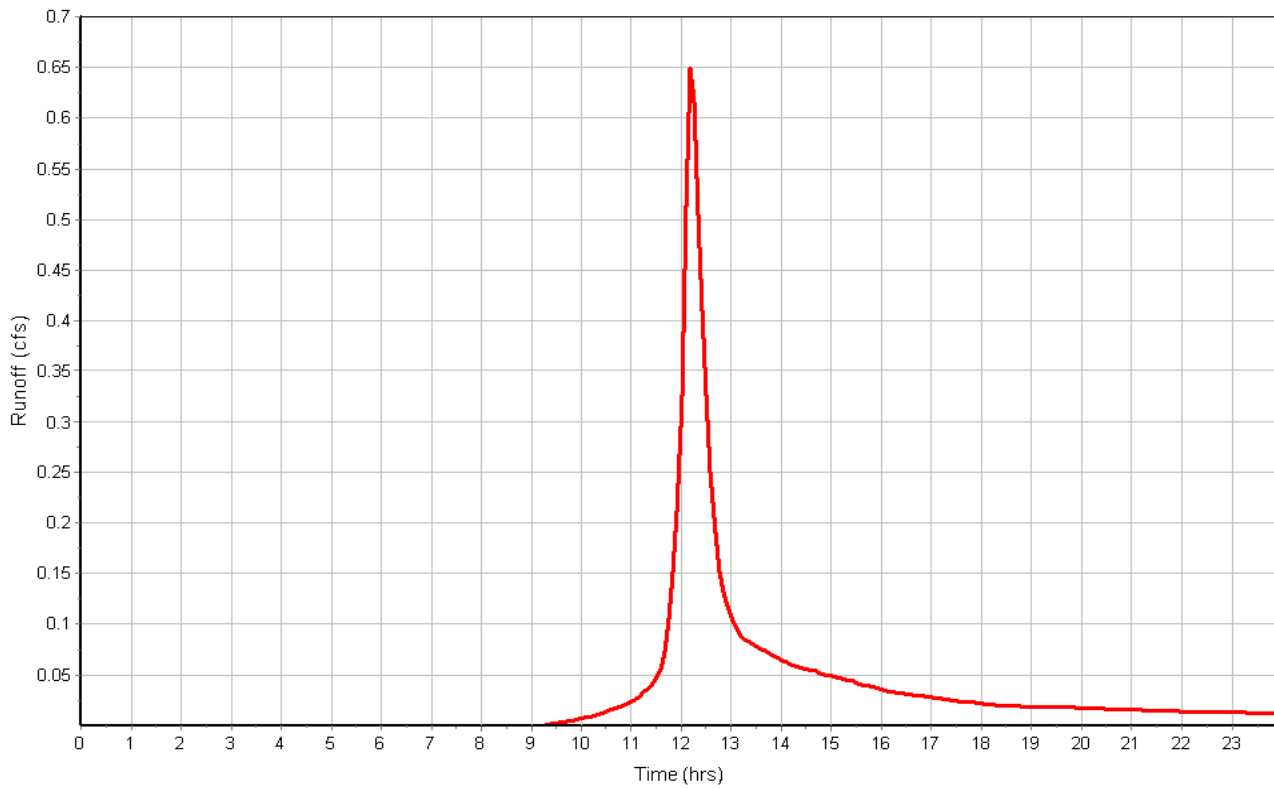

**Subbasin : D**

**Input Data**

Area (ac) ..... 0.12  
 Weighted Curve Number ..... 77.00  
 Rain Gage ID ..... Rain Gage-01

**Composite Curve Number**

Soil/Surface Description	Area (acres)	Soil Group	Curve Number
Woods, Good	0.12	D	77.00
Composite Area & Weighted CN	0.12		77.00

**Time of Concentration**

Sheet Flow Computations	Subarea	Subarea	Subarea
	A	B	C
Manning's Roughness :	.4	0.00	0.00
Flow Length (ft) :	36	0.00	0.00
Slope (%) :	5.55	0.00	0.00
2 yr, 24 hr Rainfall (in) :	3.00	0.00	0.00
Velocity (ft/sec) :	0.09	0.00	0.00
Computed Flow Time (min) :	6.51	0.00	0.00
Total TOC (min) .....	6.51		

**Subbasin Runoff Results**

Total Rainfall (in) ..... 4.70  
 Total Runoff (in) ..... 2.37  
 Peak Runoff (cfs) ..... 0.30  
 Weighted Curve Number ..... 77.00  
 Time of Concentration (days hh:mm:ss) ..... 0 00:06:31

Subbasin : D

Rainfall Intensity Graph

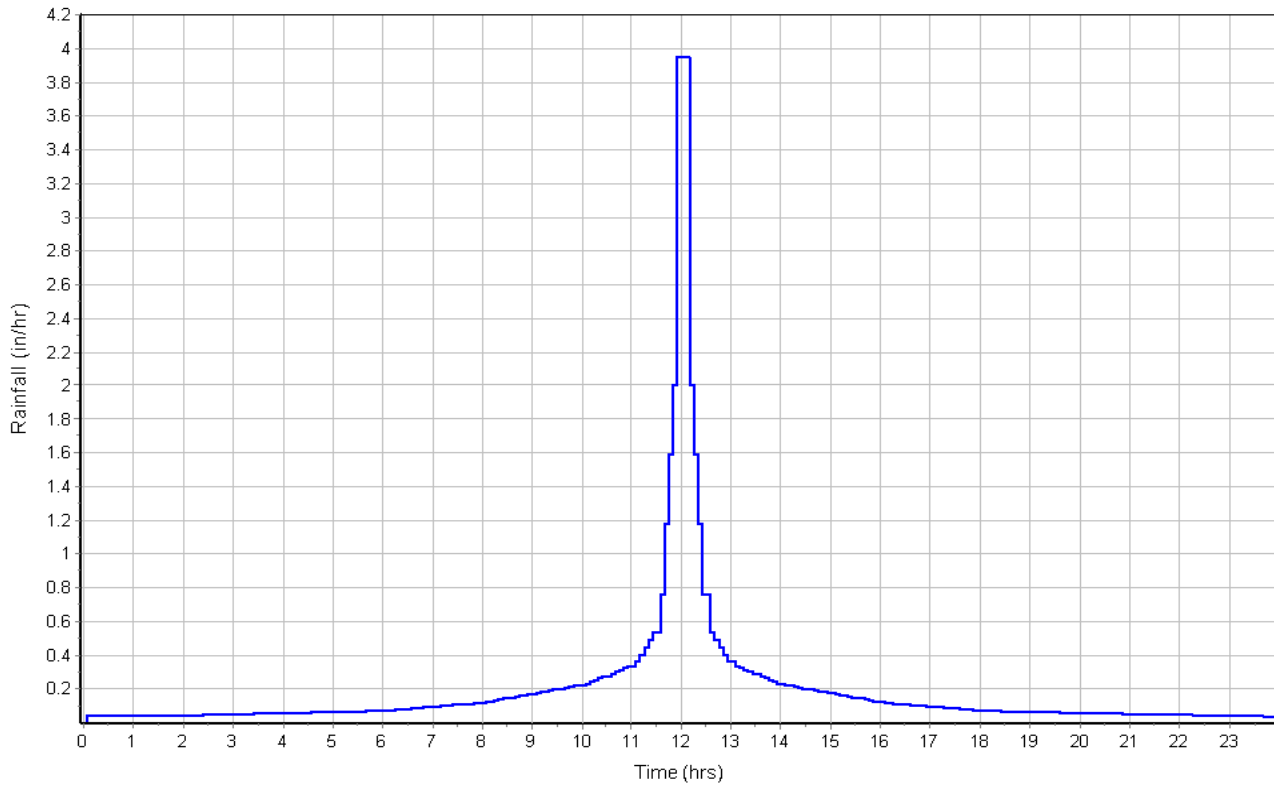

Runoff Hydrograph

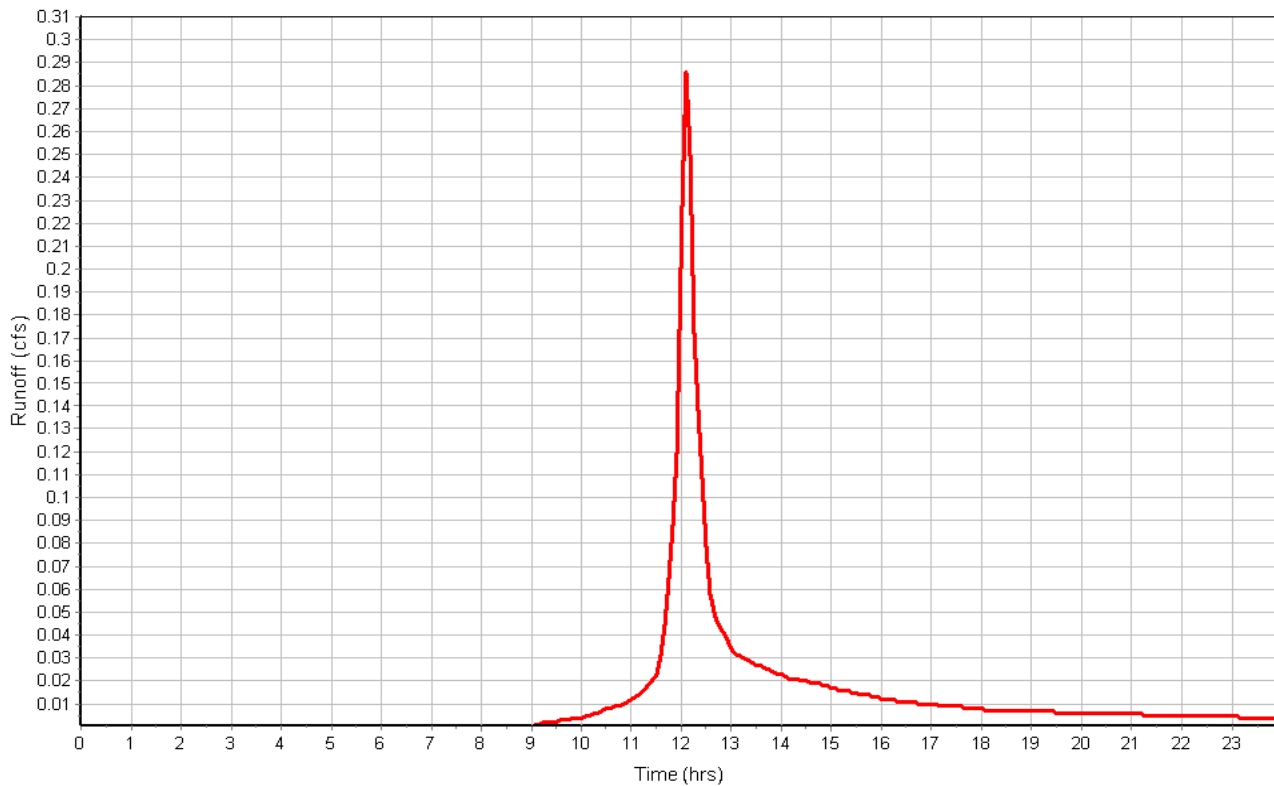

## Project Description

File Name ..... Existing Conditions.SPF

## Project Options

Flow Units ..... CFS  
 Elevation Type ..... Elevation  
 Hydrology Method ..... SCS TR-55  
 Time of Concentration (TOC) Method ..... SCS TR-55  
 Link Routing Method ..... Kinematic Wave  
 Enable Overflow Ponding at Nodes ..... YES  
 Skip Steady State Analysis Time Periods ..... NO

## Analysis Options

Start Analysis On ..... Aug 10, 2017 00:00:00  
 End Analysis On ..... Aug 11, 2017 00:00:00  
 Start Reporting On ..... Aug 10, 2017 00:00:00  
 Antecedent Dry Days ..... 0 days  
 Runoff (Dry Weather) Time Step ..... 0 01:00:00 days hh:mm:ss  
 Runoff (Wet Weather) Time Step ..... 0 00:05:00 days hh:mm:ss  
 Reporting Time Step ..... 0 00:05:00 days hh:mm:ss  
 Routing Time Step ..... 30 seconds

## Number of Elements

	Qty
Rain Gages .....	1
Subbasins.....	4
Nodes.....	4
<i>Junctions</i> .....	0
<i>Outfalls</i> .....	4
<i>Flow Diversions</i> .....	0
<i>Inlets</i> .....	0
<i>Storage Nodes</i> .....	0
Links.....	0
<i>Channels</i> .....	0
<i>Pipes</i> .....	0
<i>Pumps</i> .....	0
<i>Orifices</i> .....	0
<i>Weirs</i> .....	0
<i>Outlets</i> .....	0
Pollutants .....	0
Land Uses .....	0

## Rainfall Details

SN	Rain Gage ID	Data Source	Data Source ID	Rainfall Type	Rain Units	State	County	Return Period (years)	Rainfall Depth (inches)	Rainfall Distribution
1	Rain Gage-01	Time Series	TS-25	Cumulative	inches	Maine	Cumberland (Southeast)	25	5.50	SCS Type III 24-hr

## Subbasin Summary

Subbasin ID	Area (ac)	Weighted Curve Number	Total Rainfall (in)	Total Runoff (in)	Total Runoff Volume (ac-in)	Peak Runoff (cfs)	Time of Concentration (days hh:mm:ss)
A	3.70	73.41	5.50	2.72	10.05	7.51	0 00:23:04
B	8.76	73.22	5.50	2.70	23.65	13.36	0 00:43:24
C	0.35	74.60	5.50	2.82	0.99	0.86	0 00:15:12
D	0.12	77.00	5.50	3.04	0.37	0.38	0 00:06:30



## Subbasin Hydrology

### Subbasin : A

#### Input Data

Area (ac) ..... 3.70  
 Weighted Curve Number ..... 73.41  
 Rain Gage ID ..... Rain Gage-01

#### Composite Curve Number

Soil/Surface Description	Area (acres)	Soil Group	Curve Number
Woods, Good	0.38	D	77.00
Brush, Good	3.32	D	73.00
Composite Area & Weighted CN	3.70		73.41

#### Time of Concentration

TOC Method : SCS TR-55

Sheet Flow Equation :

$$T_c = (0.007 * ((n * L_f)^{0.8}) / ((P^{0.5}) * (S_f^{0.4})))$$

Where :

T<sub>c</sub> = Time of Concentration (hr)  
 n = Manning's roughness  
 L<sub>f</sub> = Flow Length (ft)  
 P = 2 yr, 24 hr Rainfall (inches)  
 S<sub>f</sub> = Slope (ft/ft)

Shallow Concentrated Flow Equation :

V = 16.1345 \* (S<sub>f</sub><sup>0.5</sup>) (unpaved surface)  
 V = 20.3282 \* (S<sub>f</sub><sup>0.5</sup>) (paved surface)  
 V = 15.0 \* (S<sub>f</sub><sup>0.5</sup>) (grassed waterway surface)  
 V = 10.0 \* (S<sub>f</sub><sup>0.5</sup>) (nearly bare & untilled surface)  
 V = 9.0 \* (S<sub>f</sub><sup>0.5</sup>) (cultivated straight rows surface)  
 V = 7.0 \* (S<sub>f</sub><sup>0.5</sup>) (short grass pasture surface)  
 V = 5.0 \* (S<sub>f</sub><sup>0.5</sup>) (woodland surface)  
 V = 2.5 \* (S<sub>f</sub><sup>0.5</sup>) (forest w/heavy litter surface)  
 T<sub>c</sub> = (L<sub>f</sub> / V) / (3600 sec/hr)

Where:

T<sub>c</sub> = Time of Concentration (hr)  
 L<sub>f</sub> = Flow Length (ft)  
 V = Velocity (ft/sec)  
 S<sub>f</sub> = Slope (ft/ft)

Channel Flow Equation :

V = (1.49 \* (R<sup>2/3</sup>) \* (S<sub>f</sub><sup>0.5</sup>)) / n  
 R = A<sub>q</sub> / W<sub>p</sub>  
 T<sub>c</sub> = (L<sub>f</sub> / V) / (3600 sec/hr)

Where :

T<sub>c</sub> = Time of Concentration (hr)  
 L<sub>f</sub> = Flow Length (ft)  
 R = Hydraulic Radius (ft)  
 A<sub>q</sub> = Flow Area (ft<sup>2</sup>)  
 W<sub>p</sub> = Wetted Perimeter (ft)  
 V = Velocity (ft/sec)  
 S<sub>f</sub> = Slope (ft/ft)  
 n = Manning's roughness

	Subarea	Subarea	Subarea
	A	B	C
<b>Sheet Flow Computations</b>			
Manning's Roughness :	.6	0.00	0.00
Flow Length (ft) :	100	0.00	0.00
Slope (%) :	14.36	0.00	0.00
2 yr, 24 hr Rainfall (in) :	3.00	0.00	0.00
Velocity (ft/sec) :	0.12	0.00	0.00
Computed Flow Time (min) :	13.94	0.00	0.00
<b>Shallow Concentrated Flow Computations</b>			
	Subarea	Subarea	Subarea
	A	B	C
Flow Length (ft) :	625	0.00	0.00
Slope (%) :	.582	0.00	0.00
Surface Type :	Grassed waterway	Unpaved	Unpaved
Velocity (ft/sec) :	1.14	0.00	0.00
Computed Flow Time (min) :	9.14	0.00	0.00
Total TOC (min) .....	23.08		

**Subbasin Runoff Results**

Total Rainfall (in) .....	5.50
Total Runoff (in) .....	2.72
Peak Runoff (cfs) .....	7.51
Weighted Curve Number .....	73.41
Time of Concentration (days hh:mm:ss) .....	0 00:23:05

Subbasin : A

Rainfall Intensity Graph

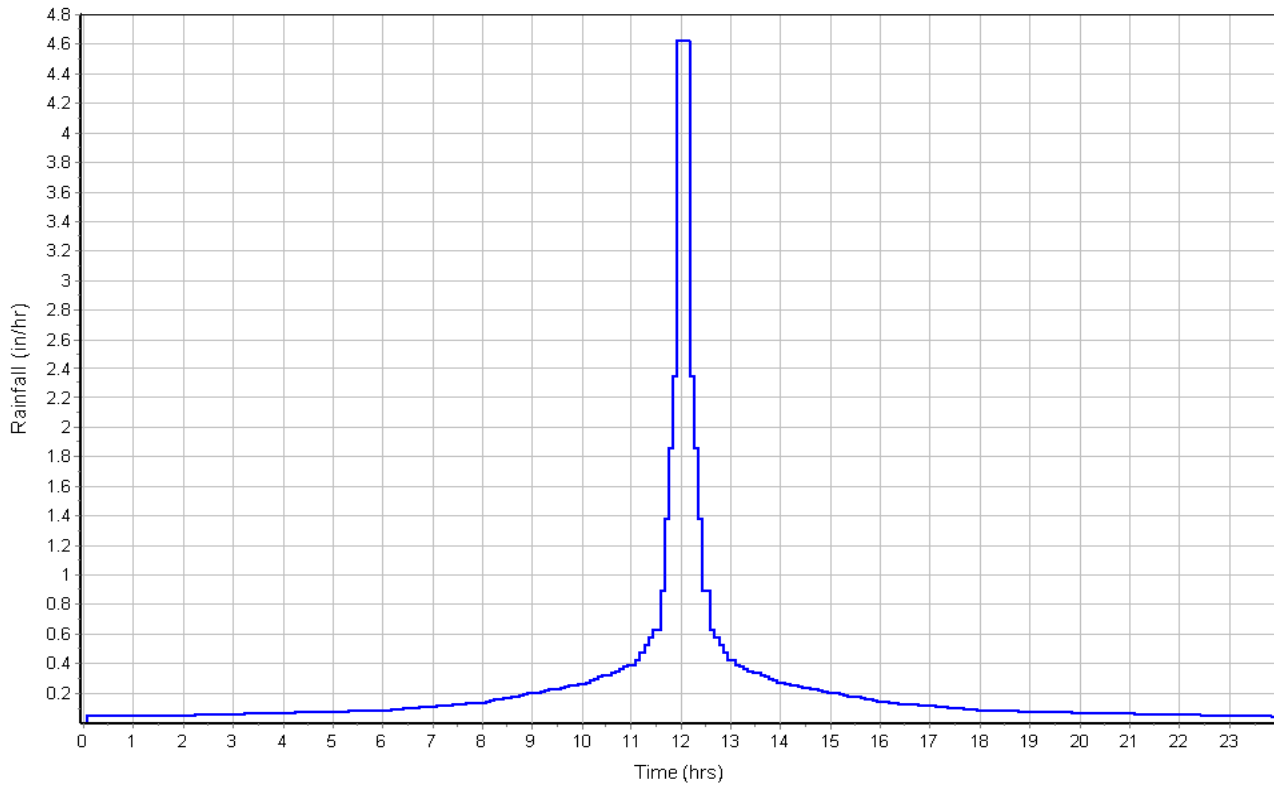

Runoff Hydrograph

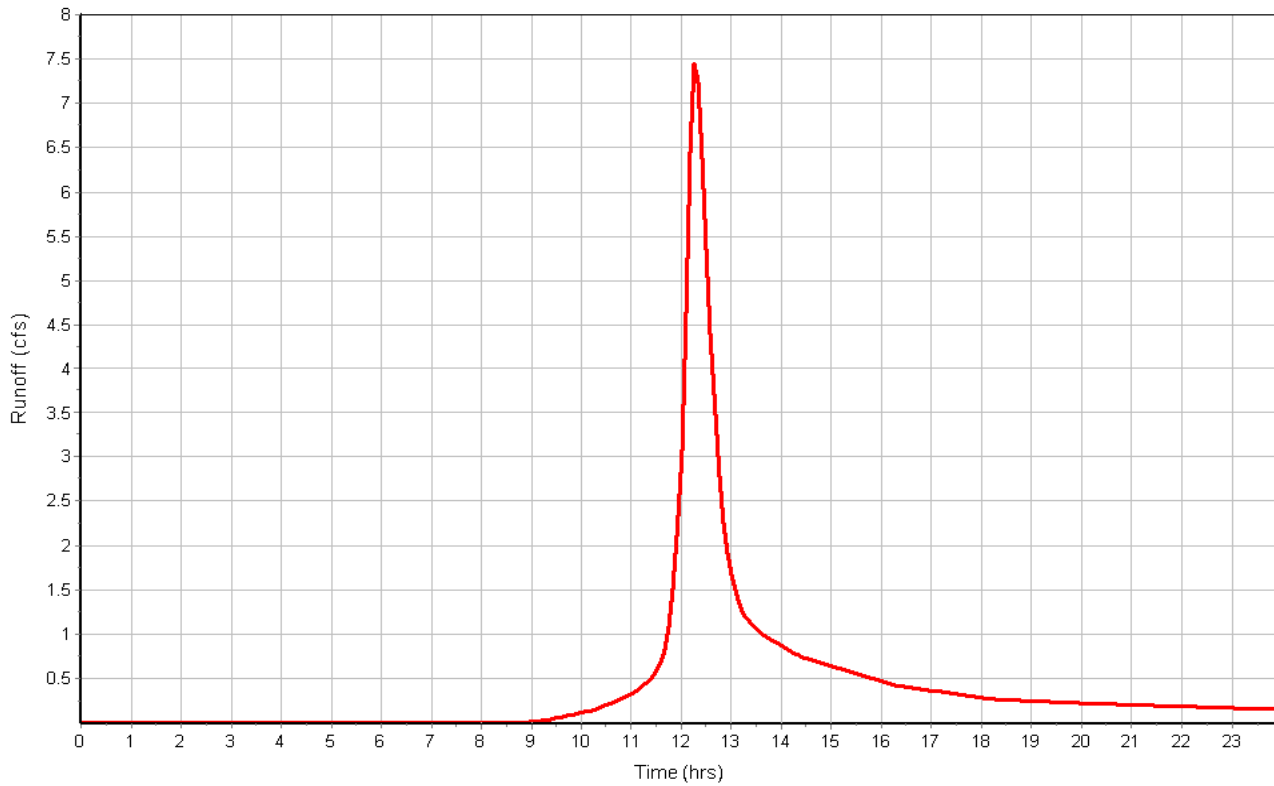

**Subbasin : B**

**Input Data**

Area (ac) ..... 8.76  
 Weighted Curve Number ..... 73.22  
 Rain Gage ID ..... Rain Gage-01

**Composite Curve Number**

Soil/Surface Description	Area (acres)	Soil Group	Curve Number
Brush, Good	8.27	D	73.00
Woods, Good	0.49	D	77.00
Composite Area & Weighted CN	8.76		73.22

**Time of Concentration**

	Subarea		
	A	B	C
Sheet Flow Computations			
Manning's Roughness :	.6	0.00	0.00
Flow Length (ft) :	100	0.00	0.00
Slope (%) :	4.25	0.00	0.00
2 yr, 24 hr Rainfall (in) :	3.00	0.00	0.00
Velocity (ft/sec) :	0.07	0.00	0.00
Computed Flow Time (min) :	22.69	0.00	0.00
Shallow Concentrated Flow Computations			
Flow Length (ft) :	758	0.00	0.00
Slope (%) :	.758	0.00	0.00
Surface Type :	Grass pasture	Unpaved	Unpaved
Velocity (ft/sec) :	0.61	0.00	0.00
Computed Flow Time (min) :	20.71	0.00	0.00
Total TOC (min) .....	43.40		

**Subbasin Runoff Results**

Total Rainfall (in) ..... 5.50  
 Total Runoff (in) ..... 2.70  
 Peak Runoff (cfs) ..... 13.36  
 Weighted Curve Number ..... 73.22  
 Time of Concentration (days hh:mm:ss) ..... 0 00:43:24

**Subbasin : B**

**Rainfall Intensity Graph**

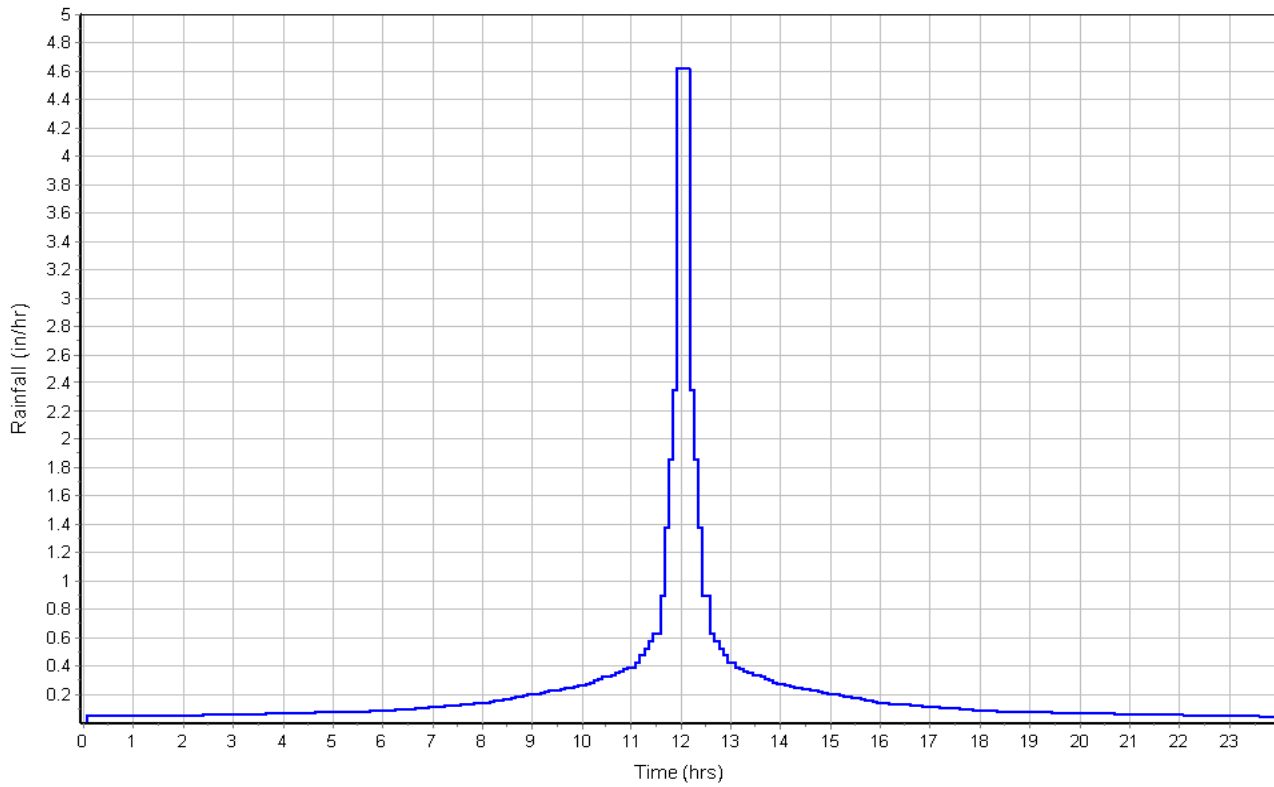

**Runoff Hydrograph**

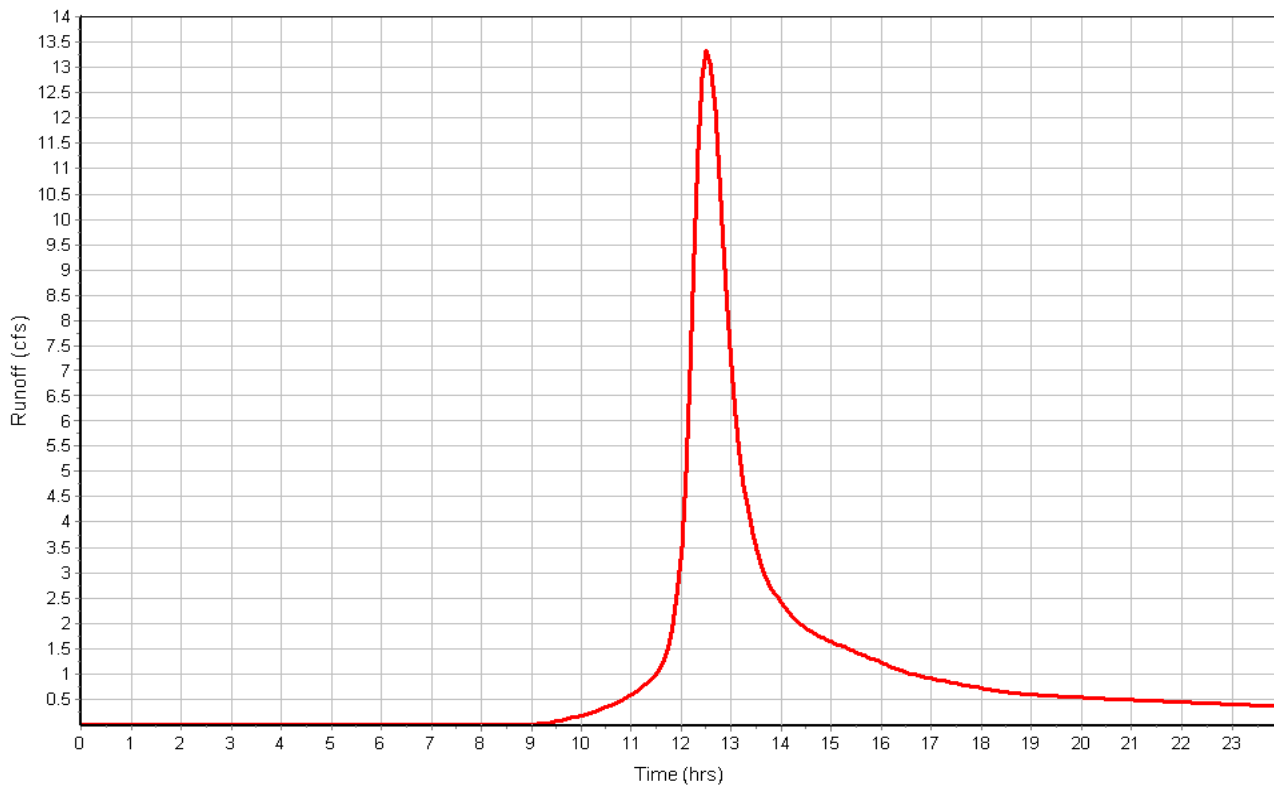

**Subbasin : C**

**Input Data**

Area (ac) ..... 0.35  
 Weighted Curve Number ..... 74.60  
 Rain Gage ID ..... Rain Gage-01

**Composite Curve Number**

Soil/Surface Description	Area (acres)	Soil Group	Curve Number
Woods, Good	0.03	D	77.00
Woods, Good	0.04	D	77.00
Brush, Good	0.08	D	73.00
Brush, Good	0.13	D	73.00
Woods, Good	0.07	D	77.00
Composite Area & Weighted CN	0.35		74.60

**Time of Concentration**

	Subarea	Subarea	Subarea
	A	B	C
Sheet Flow Computations			
Manning's Roughness :	.4	0.00	0.00
Flow Length (ft) :	87	0.00	0.00
Slope (%) :	10.35	0.00	0.00
2 yr, 24 hr Rainfall (in) :	3.00	0.00	0.00
Velocity (ft/sec) :	0.14	0.00	0.00
Computed Flow Time (min) :	10.28	0.00	0.00
Shallow Concentrated Flow Computations			
Flow Length (ft) :	313	0.00	0.00
Slope (%) :	2.3	0.00	0.00
Surface Type :	Grass pasture	Unpaved	Unpaved
Velocity (ft/sec) :	1.06	0.00	0.00
Computed Flow Time (min) :	4.92	0.00	0.00
Total TOC (min) .....	15.20		

**Subbasin Runoff Results**

Total Rainfall (in) ..... 5.50  
 Total Runoff (in) ..... 2.82  
 Peak Runoff (cfs) ..... 0.86  
 Weighted Curve Number ..... 74.60  
 Time of Concentration (days hh:mm:ss) ..... 0 00:15:12

Subbasin : C

Rainfall Intensity Graph

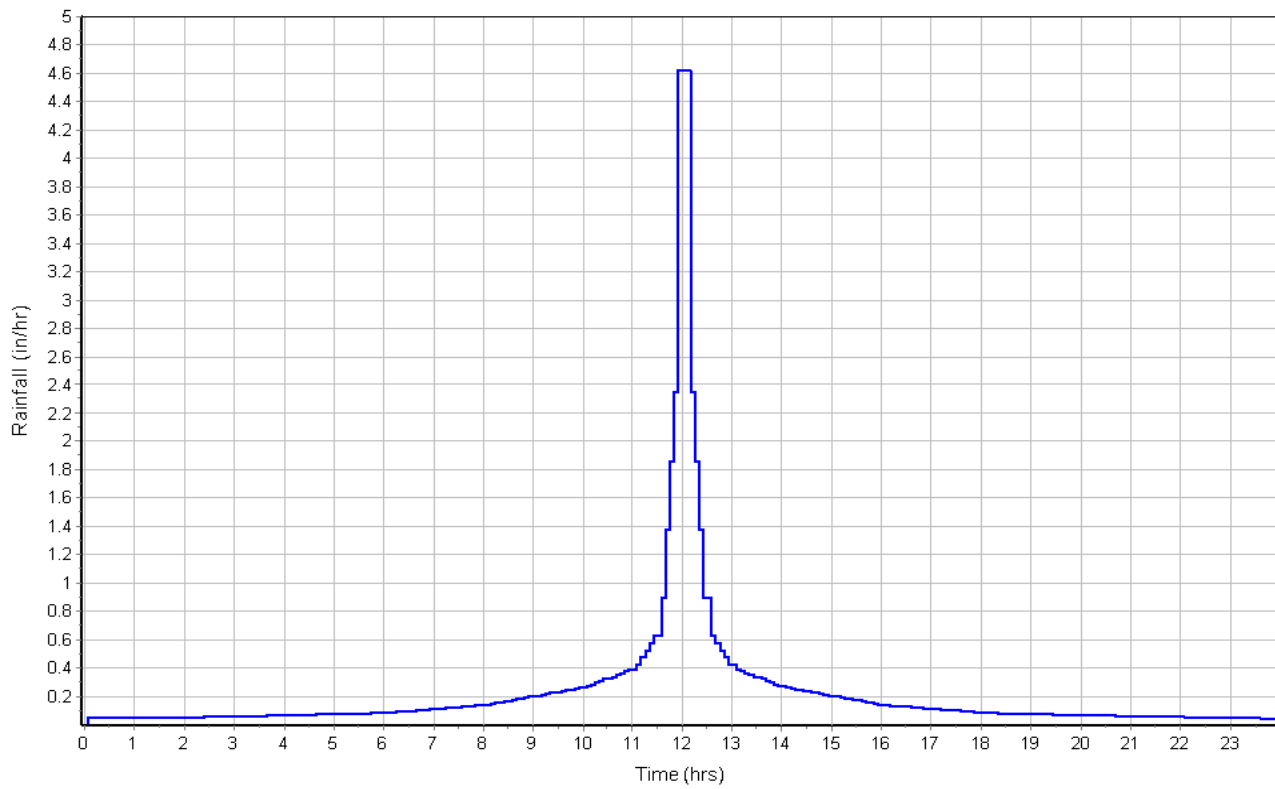

Runoff Hydrograph

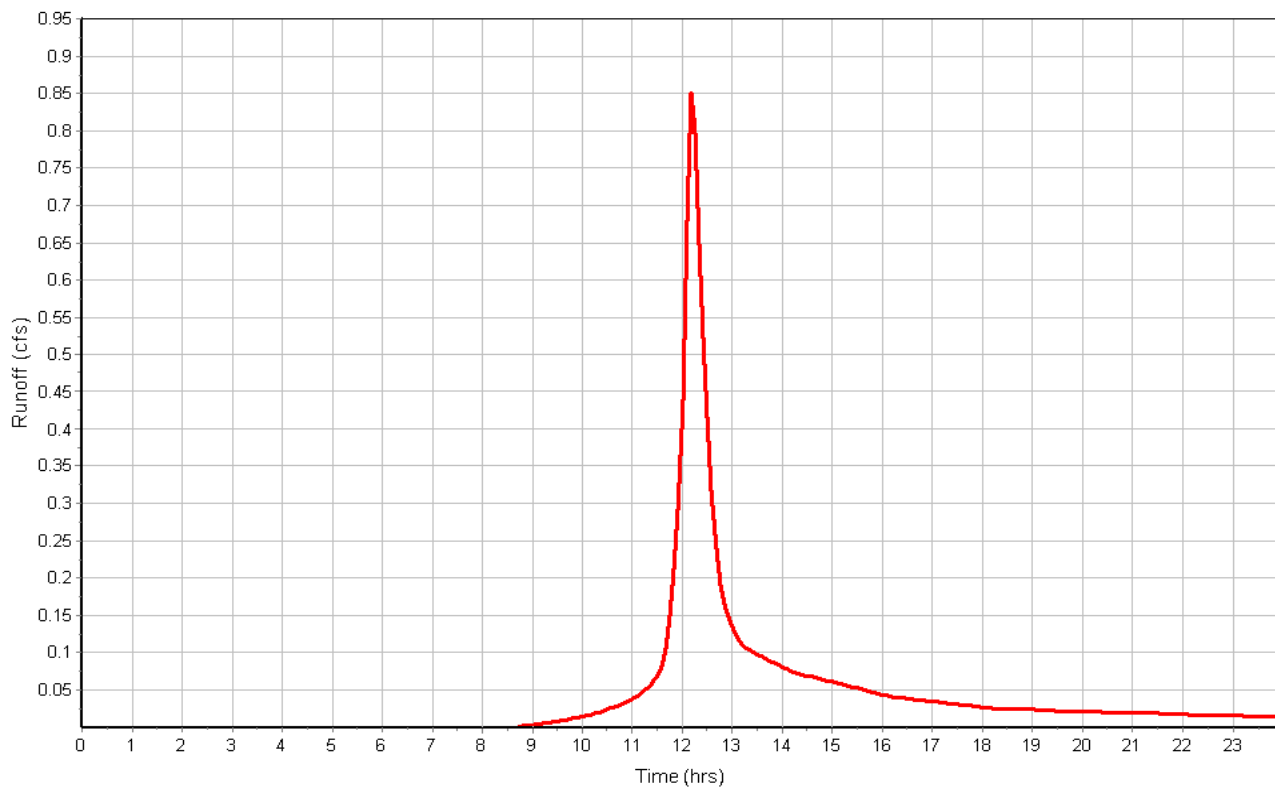

**Subbasin : D**

**Input Data**

Area (ac) ..... 0.12  
 Weighted Curve Number ..... 77.00  
 Rain Gage ID ..... Rain Gage-01

**Composite Curve Number**

Soil/Surface Description	Area (acres)	Soil Group	Curve Number
Woods, Good	0.12	D	77.00
Composite Area & Weighted CN	0.12		77.00

**Time of Concentration**

Sheet Flow Computations	Subarea	Subarea	Subarea
	A	B	C
Manning's Roughness :	.4	0.00	0.00
Flow Length (ft) :	36	0.00	0.00
Slope (%) :	5.55	0.00	0.00
2 yr, 24 hr Rainfall (in) :	3.00	0.00	0.00
Velocity (ft/sec) :	0.09	0.00	0.00
Computed Flow Time (min) :	6.51	0.00	0.00
Total TOC (min) .....	6.51		

**Subbasin Runoff Results**

Total Rainfall (in) ..... 5.50  
 Total Runoff (in) ..... 3.04  
 Peak Runoff (cfs) ..... 0.38  
 Weighted Curve Number ..... 77.00  
 Time of Concentration (days hh:mm:ss) ..... 0 00:06:31



Subbasin : D

Rainfall Intensity Graph

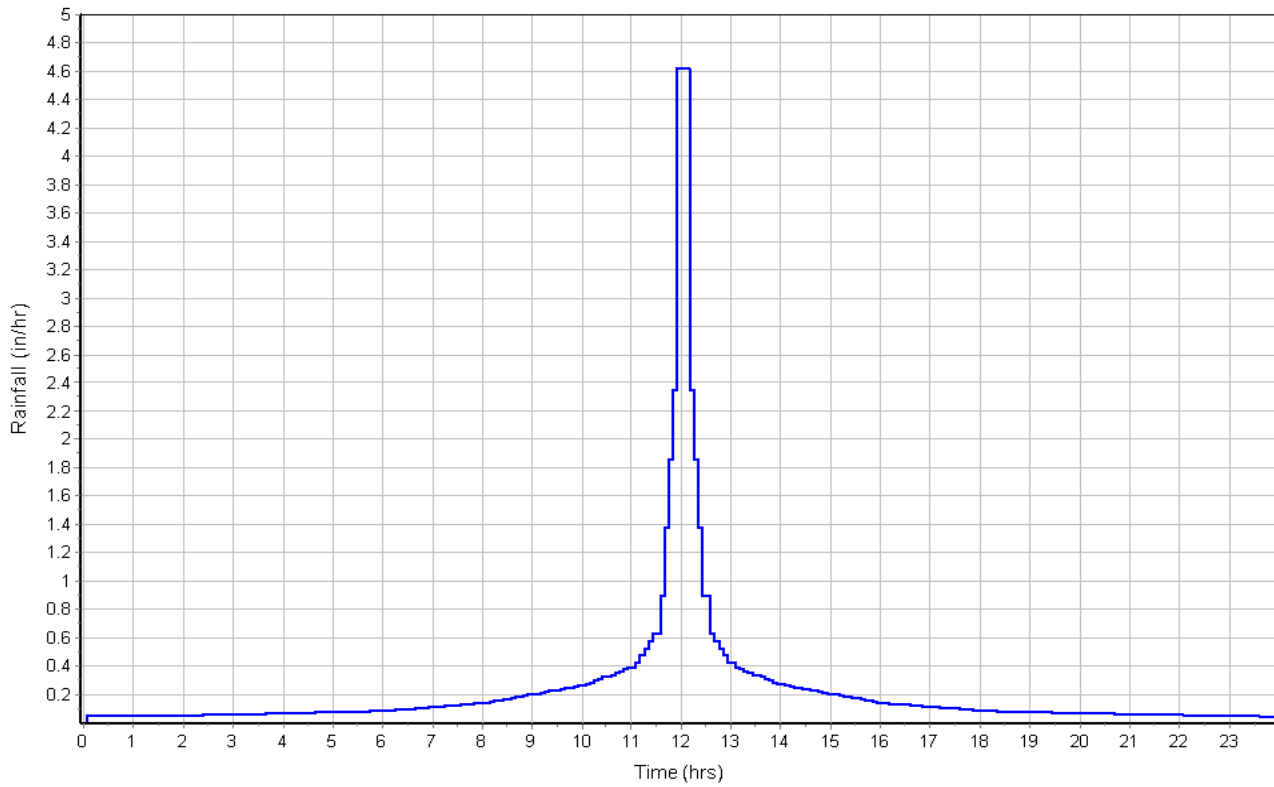

Runoff Hydrograph

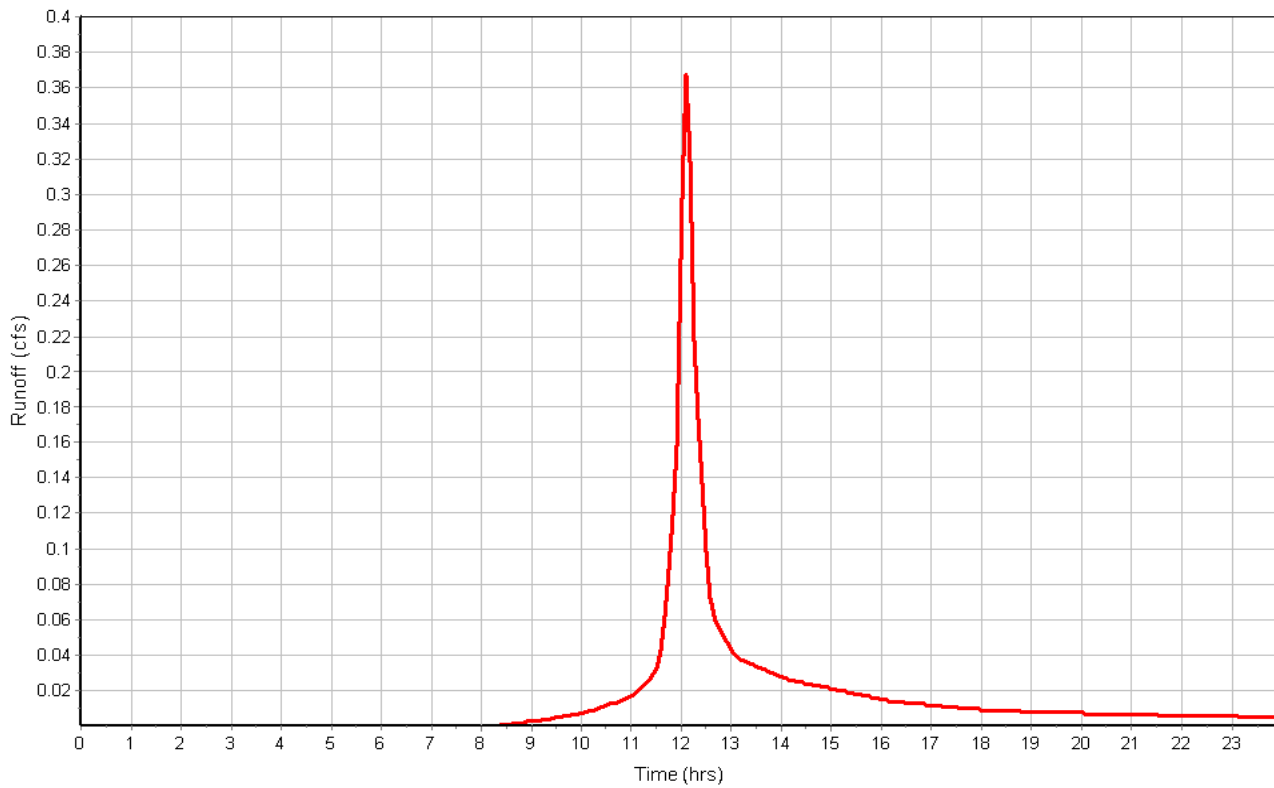

## Project Description

File Name ..... Proposed Conditions\_SMT.SPF

## Project Options

Flow Units ..... CFS  
 Elevation Type ..... Elevation  
 Hydrology Method ..... SCS TR-55  
 Time of Concentration (TOC) Method ..... SCS TR-55  
 Link Routing Method ..... Kinematic Wave  
 Enable Overflow Ponding at Nodes ..... YES  
 Skip Steady State Analysis Time Periods ..... NO

## Analysis Options

Start Analysis On ..... Aug 15, 2017 00:00:00  
 End Analysis On ..... Aug 17, 2017 00:00:00  
 Start Reporting On ..... Aug 15, 2017 00:00:00  
 Antecedent Dry Days ..... 0 days  
 Runoff (Dry Weather) Time Step ..... 0 01:00:00 days hh:mm:ss  
 Runoff (Wet Weather) Time Step ..... 0 00:05:00 days hh:mm:ss  
 Reporting Time Step ..... 0 00:05:00 days hh:mm:ss  
 Routing Time Step ..... 30 seconds

## Number of Elements

	Qty
Rain Gages .....	1
Subbasins.....	6
Nodes.....	7
<i>Junctions</i> .....	2
<i>Outfalls</i> .....	5
<i>Flow Diversions</i> .....	0
<i>Inlets</i> .....	0
<i>Storage Nodes</i> .....	0
Links.....	2
<i>Channels</i> .....	0
<i>Pipes</i> .....	2
<i>Pumps</i> .....	0
<i>Orifices</i> .....	0
<i>Weirs</i> .....	0
<i>Outlets</i> .....	0
Pollutants .....	0
Land Uses .....	0

## Rainfall Details

SN	Rain Gage ID	Data Source	Data Source ID	Rainfall Type	Rain Units	State	County	Return Period (years)	Rainfall Depth (inches)	Rainfall Distribution
1	Rain Gage-01	Time Series	TS-02	Cumulative	inches	Maine	Cumberland (Southeast)	2	3.00	SCS Type III 24-hr

## Subbasin Summary

Subbasin ID	Area (ac)	Weighted Curve Number	Total Rainfall (in)	Total Runoff (in)	Total Runoff Volume (ac-in)	Peak Runoff (cfs)	Time of Concentration (days hh:mm:ss)
A	3.95	74.46	3.00	0.93	3.68	2.33	0 00:29:55
B-1	2.55	66.95	3.00	0.58	1.49	1.30	0 00:07:01
B-2	7.03	70.54	3.00	0.74	5.20	1.84	0 01:17:51
C	0.21	75.29	3.00	0.98	0.20	0.15	0 00:20:30
CulvertDrainageArea	0.68	75.00	3.00	0.96	0.65	0.67	0 00:05:00
D	0.12	77.00	3.00	1.07	0.13	0.13	0 00:06:30

## Node Summary

Element ID	Element Type	Invert Elevation	Peak Inflow
		(ft)	(cfs)
CulvertInlet	Junction	181.00	0.64
Out_B1andB2	Junction	176.00	2.06
CulvertOutlet	Outfall	180.35	0.64
OUT-A	Outfall	180.00	2.31
OUT-B	Outfall	176.00	2.06
OUT-C	Outfall	178.00	0.15
OUT-D	Outfall	190.82	0.12

## Link Summary

Element ID	Element Type	From (Inlet) Node	To (Outlet) Node	Length (ft)	Inlet Invert Elevation (ft)	Outlet Invert Elevation (ft)	Average Slope (%)	Diameter or Height (in)	Manning's Roughness	Peak Flow (cfs)	Design Flow Capacity (cfs)	Peak Flow Velocity (ft/sec)	Peak Flow Depth (ft)
Direct_to_OutB Link-03	Pipe	Out_B1andB2	OUT-B	1715.96	0.00	0.00	0.0000	0.000	0.0150	2.06	0.00	0.00	0.00
	Pipe	CulvertInlet	CulvertOutlet	45.00	181.00	180.55	1.0000	15.000	0.0150	0.64	5.60	3.04	0.29

## Subbasin Hydrology

### Subbasin : A

#### Input Data

Area (ac) ..... 3.95  
Weighted Curve Number ..... 74.46  
Rain Gage ID ..... Rain Gage-01

#### Composite Curve Number

Soil/Surface Description	Area (acres)	Soil Group	Curve Number
Woods, Good	0.33	D	77.00
Gravel roads	0.10	D	91.00
> 75% grass cover, Good	0.38	D	80.00
Brush, Good	3.14	D	73.00
Composite Area & Weighted CN	3.95		74.46

#### Time of Concentration

TOC Method : SCS TR-55

Sheet Flow Equation :

$$T_c = (0.007 * ((n * L_f)^{0.8})) / ((P^{0.5}) * (S_f^{0.4}))$$

Where :

T<sub>c</sub> = Time of Concentration (hr)  
n = Manning's roughness  
L<sub>f</sub> = Flow Length (ft)  
P = 2 yr, 24 hr Rainfall (inches)  
S<sub>f</sub> = Slope (ft/ft)

Shallow Concentrated Flow Equation :

V = 16.1345 \* (S<sub>f</sub><sup>0.5</sup>) (unpaved surface)  
V = 20.3282 \* (S<sub>f</sub><sup>0.5</sup>) (paved surface)  
V = 15.0 \* (S<sub>f</sub><sup>0.5</sup>) (grassed waterway surface)  
V = 10.0 \* (S<sub>f</sub><sup>0.5</sup>) (nearly bare & untilled surface)  
V = 9.0 \* (S<sub>f</sub><sup>0.5</sup>) (cultivated straight rows surface)  
V = 7.0 \* (S<sub>f</sub><sup>0.5</sup>) (short grass pasture surface)  
V = 5.0 \* (S<sub>f</sub><sup>0.5</sup>) (woodland surface)  
V = 2.5 \* (S<sub>f</sub><sup>0.5</sup>) (forest w/heavy litter surface)  
T<sub>c</sub> = (L<sub>f</sub> / V) / (3600 sec/hr)

Where:

T<sub>c</sub> = Time of Concentration (hr)  
L<sub>f</sub> = Flow Length (ft)  
V = Velocity (ft/sec)  
S<sub>f</sub> = Slope (ft/ft)

Channel Flow Equation :

V = (1.49 \* (R<sup>2/3</sup>) \* (S<sub>f</sub><sup>0.5</sup>)) / n  
R = A<sub>q</sub> / W<sub>p</sub>  
T<sub>c</sub> = (L<sub>f</sub> / V) / (3600 sec/hr)

Where :

T<sub>c</sub> = Time of Concentration (hr)  
L<sub>f</sub> = Flow Length (ft)  
R = Hydraulic Radius (ft)  
A<sub>q</sub> = Flow Area (ft<sup>2</sup>)  
W<sub>p</sub> = Wetted Perimeter (ft)  
V = Velocity (ft/sec)  
S<sub>f</sub> = Slope (ft/ft)  
n = Manning's roughness

	Subarea	Subarea	Subarea
	A	B	C
<b>Sheet Flow Computations</b>			
Manning's Roughness :	.4	0.00	0.00
Flow Length (ft) :	45	0.00	0.00
Slope (%) :	50	0.00	0.00
2 yr, 24 hr Rainfall (in) :	3.00	0.00	0.00
Velocity (ft/sec) :	0.23	0.00	0.00
Computed Flow Time (min) :	3.23	0.00	0.00
	Subarea	Subarea	Subarea
	A	B	C
<b>Shallow Concentrated Flow Computations</b>			
Flow Length (ft) :	264	574	0.00
Slope (%) :	.76	.35	0.00
Surface Type :	Grassed waterway	Grass pasture	Unpaved
Velocity (ft/sec) :	1.31	0.41	0.00
Computed Flow Time (min) :	3.36	23.33	0.00
Total TOC (min) .....	29.92		

**Subbasin Runoff Results**

Total Rainfall (in) .....	3.00
Total Runoff (in) .....	0.93
Peak Runoff (cfs) .....	2.33
Weighted Curve Number .....	74.46
Time of Concentration (days hh:mm:ss) .....	0 00:29:55

Subbasin : A

Rainfall Intensity Graph

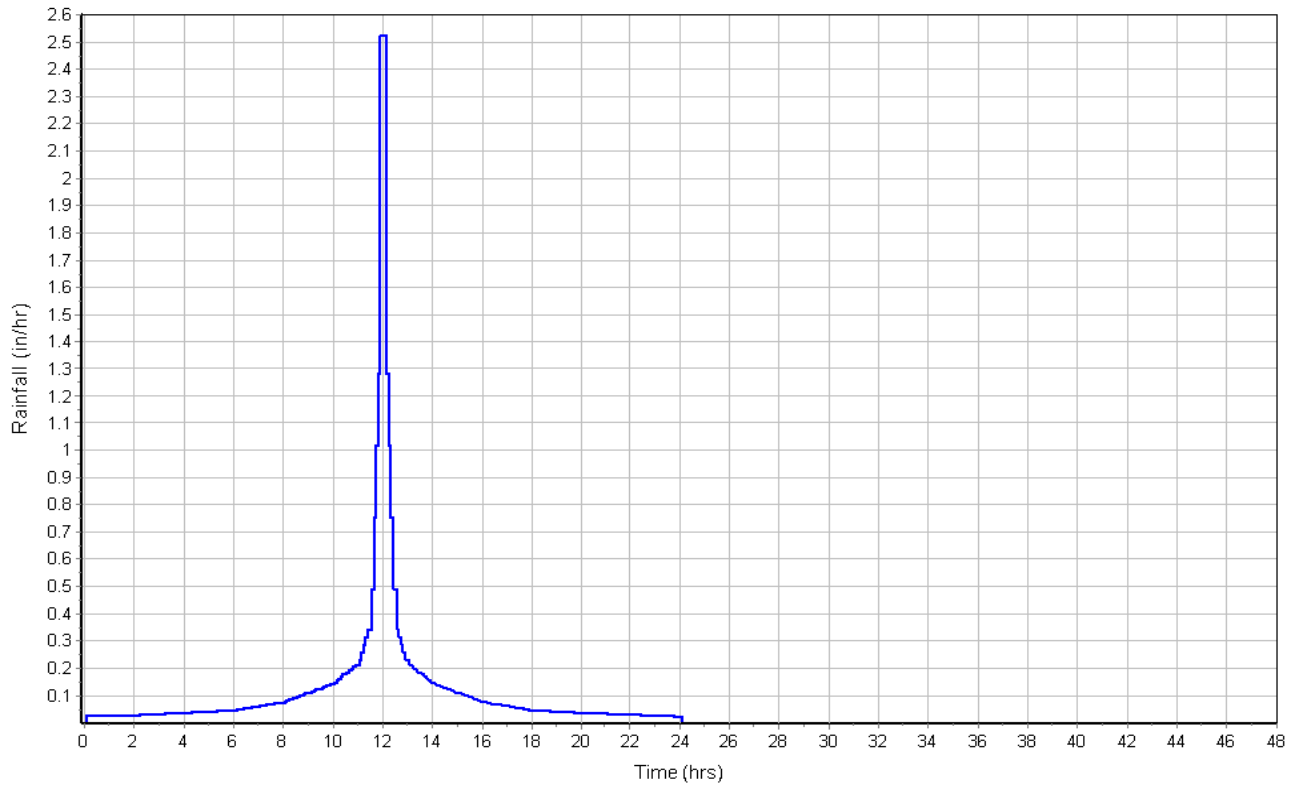

Runoff Hydrograph

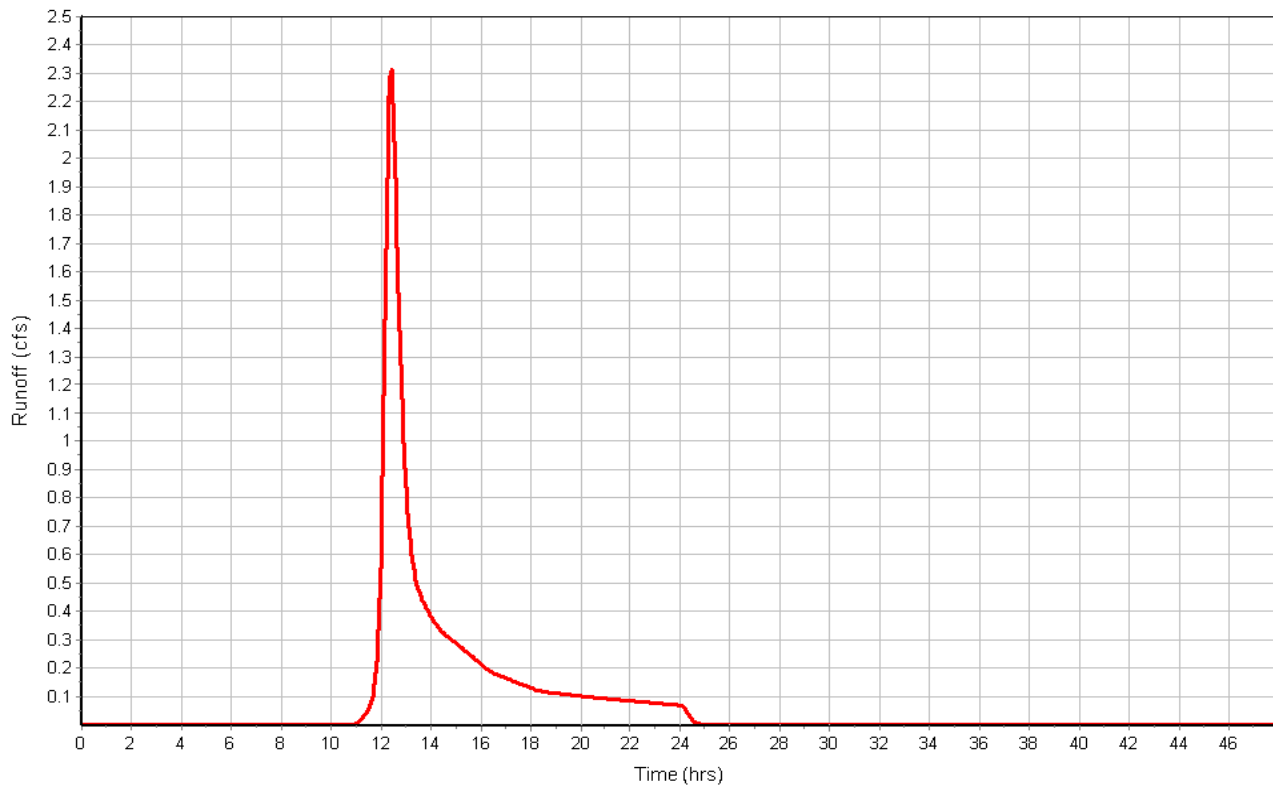



**Subbasin : B-1**

**Input Data**

Area (ac) ..... 2.55  
 Weighted Curve Number ..... 66.95  
 Rain Gage ID ..... Rain Gage-01

**Composite Curve Number**

Soil/Surface Description	Area (acres)	Soil Group	Curve Number
Gravel-Pad	1.88	D	60.00
Rooftops	0.24	D	98.00
> 75% grass cover, Good	0.43	D	80.00
Composite Area & Weighted CN	2.55		66.95

**Time of Concentration**

	Subarea		
	A	B	C
Sheet Flow Computations			
Manning's Roughness :	.4	0.00	0.00
Flow Length (ft) :	38	0.00	0.00
Slope (%) :	50	0.00	0.00
2 yr, 24 hr Rainfall (in) :	3.00	0.00	0.00
Velocity (ft/sec) :	0.22	0.00	0.00
Computed Flow Time (min) :	2.82	0.00	0.00
Shallow Concentrated Flow Computations			
Flow Length (ft) :	385	0.00	0.00
Slope (%) :	1.04	0.00	0.00
Surface Type :	Grassed waterway	Grass pasture	Grass pasture
Velocity (ft/sec) :	1.53	0.00	0.00
Computed Flow Time (min) :	4.19	0.00	0.00
Total TOC (min) .....7.02			

**Subbasin Runoff Results**

Total Rainfall (in) ..... 3.00  
 Total Runoff (in) ..... 0.58  
 Peak Runoff (cfs) ..... 1.30  
 Weighted Curve Number ..... 66.95  
 Time of Concentration (days hh:mm:ss) ..... 0 00:07:01

**Subbasin : B-1**

**Rainfall Intensity Graph**

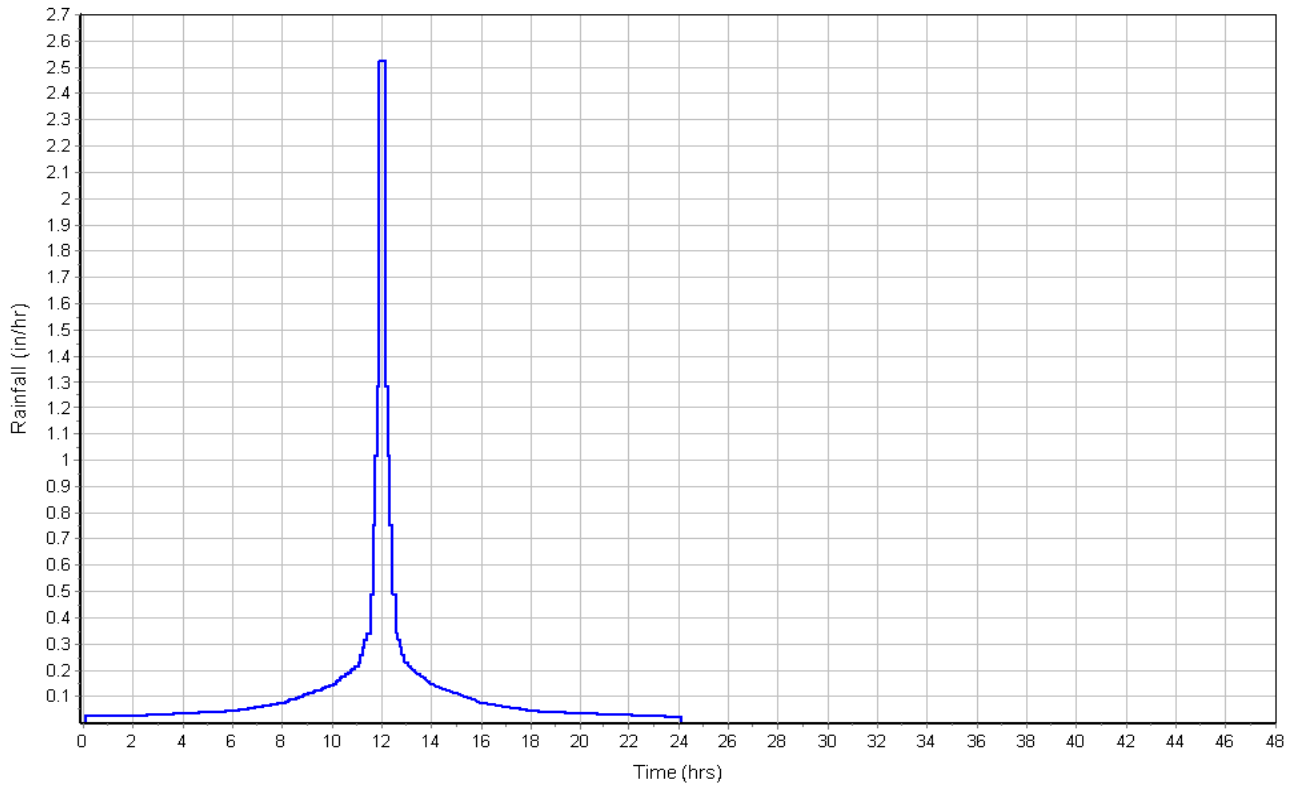

**Runoff Hydrograph**

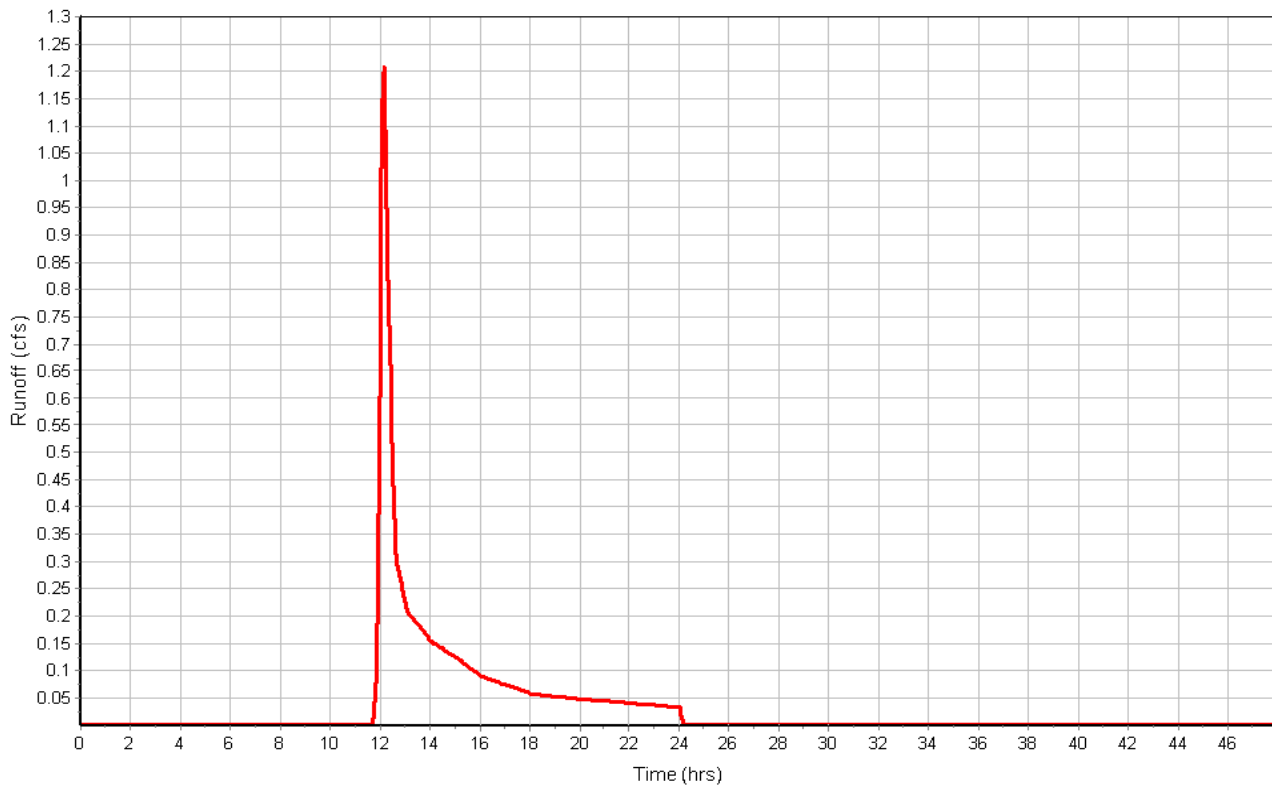

**Subbasin : B-2**

**Input Data**

Area (ac) ..... 7.03  
 Weighted Curve Number ..... 70.54  
 Rain Gage ID ..... Rain Gage-01

**Composite Curve Number**

Soil/Surface Description	Area (acres)	Soil Group	Curve Number
Brush, Good	5.19	D	73.00
Gravel roads	0.05	D	91.00
> 75% grass cover, Good	0.16	D	80.00
Gravel_Pad	1.58	D	60.00
ConcreteFoundations	0.05	D	98.00
Composite Area & Weighted CN	7.03		70.54

**Time of Concentration**

	Subarea A	Subarea B	Subarea C
Sheet Flow Computations			
Manning's Roughness :	.4	0.00	0.00
Flow Length (ft) :	100	0.00	0.00
Slope (%) :	.25	0.00	0.00
2 yr, 24 hr Rainfall (in) :	3.00	0.00	0.00
Velocity (ft/sec) :	0.03	0.00	0.00
Computed Flow Time (min) :	50.95	0.00	0.00
Shallow Concentrated Flow Computations			
Flow Length (ft) :	791	0.00	0.00
Slope (%) :	.5	0.00	0.00
Surface Type :	Grass pasture	Unpaved	Unpaved
Velocity (ft/sec) :	0.49	0.00	0.00
Computed Flow Time (min) :	26.90	0.00	0.00
Total TOC (min) .....	77.86		

**Subbasin Runoff Results**

Total Rainfall (in) ..... 3.00  
 Total Runoff (in) ..... 0.74  
 Peak Runoff (cfs) ..... 1.84  
 Weighted Curve Number ..... 70.54  
 Time of Concentration (days hh:mm:ss) ..... 0 01:17:52

**Subbasin : B-2**

**Rainfall Intensity Graph**

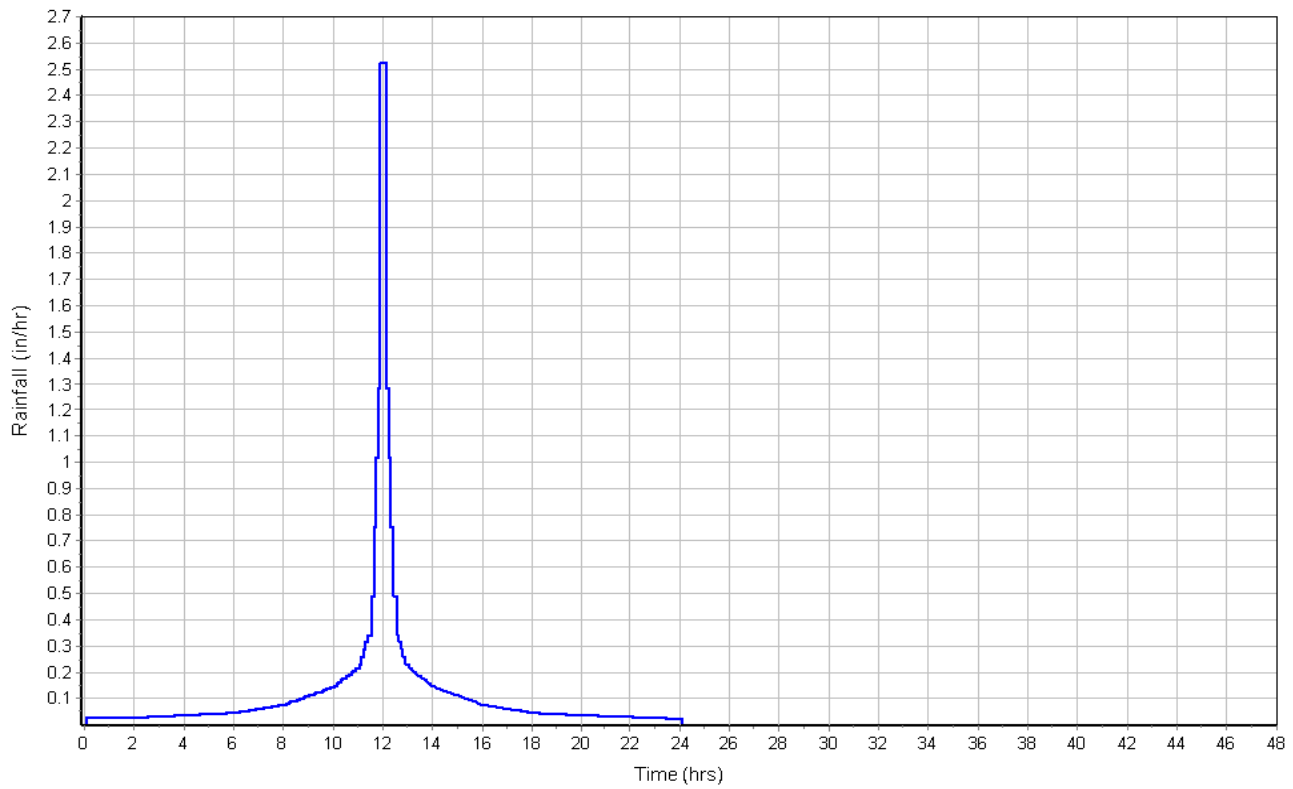

**Runoff Hydrograph**

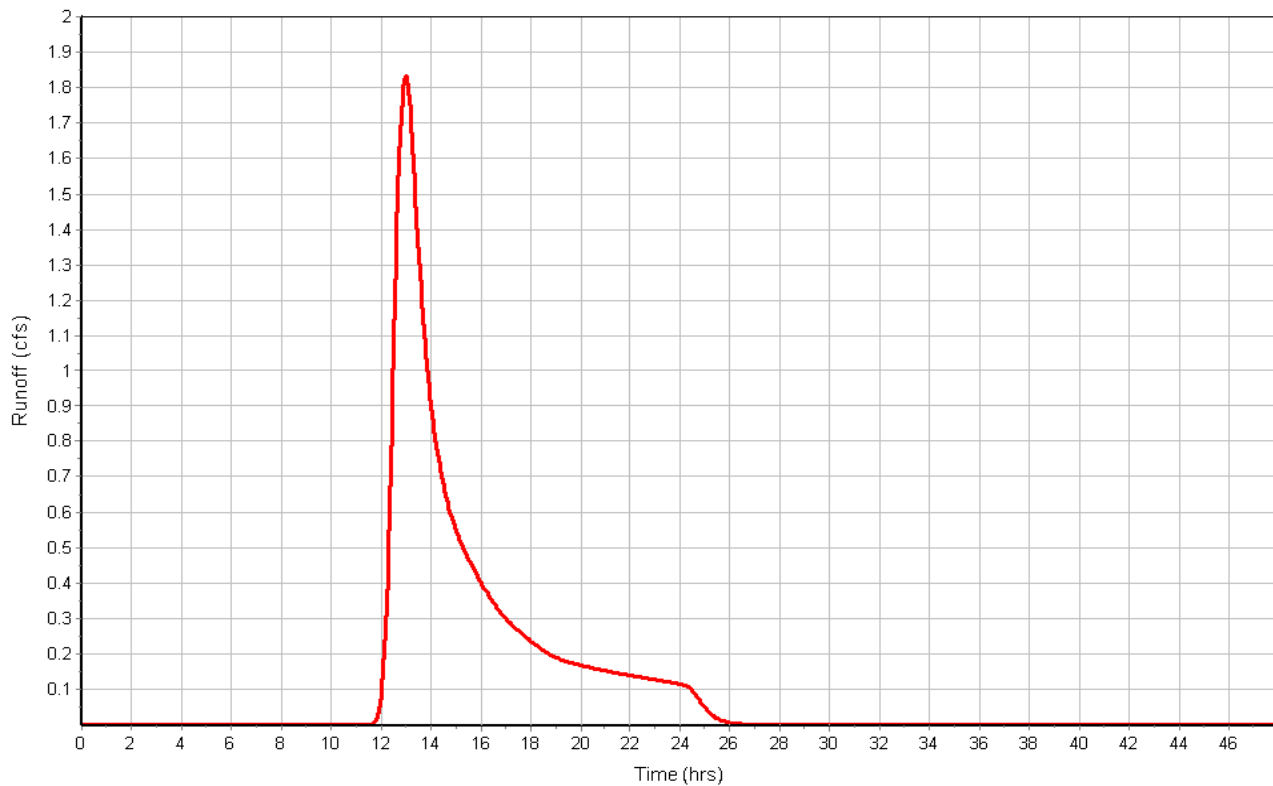

**Subbasin : C**

**Input Data**

Area (ac) ..... 0.21  
 Weighted Curve Number ..... 75.29  
 Rain Gage ID ..... Rain Gage-01

**Composite Curve Number**

Soil/Surface Description	Area (acres)	Soil Group	Curve Number
Woods, Good	0.12	D	77.00
Brush, Good	0.09	D	73.00
Composite Area & Weighted CN	0.21		75.29

**Time of Concentration**

	Subarea		
	A	B	C
Sheet Flow Computations			
Manning's Roughness :	.6	0.00	0.00
Flow Length (ft) :	80	0.00	0.00
Slope (%) :	4.31	0.00	0.00
2 yr, 24 hr Rainfall (in) :	3.00	0.00	0.00
Velocity (ft/sec) :	0.07	0.00	0.00
Computed Flow Time (min) :	18.88	0.00	0.00
Shallow Concentrated Flow Computations			
Flow Length (ft) :	182	0.00	0.00
Slope (%) :	7.1	0.00	0.00
Surface Type :	Grass pasture	Unpaved	Unpaved
Velocity (ft/sec) :	1.87	0.00	0.00
Computed Flow Time (min) :	1.62	0.00	0.00
Total TOC (min) .....	20.50		

**Subbasin Runoff Results**

Total Rainfall (in) ..... 3.00  
 Total Runoff (in) ..... 0.98  
 Peak Runoff (cfs) ..... 0.15  
 Weighted Curve Number ..... 75.29  
 Time of Concentration (days hh:mm:ss) ..... 0 00:20:30

**Subbasin : C**

**Rainfall Intensity Graph**

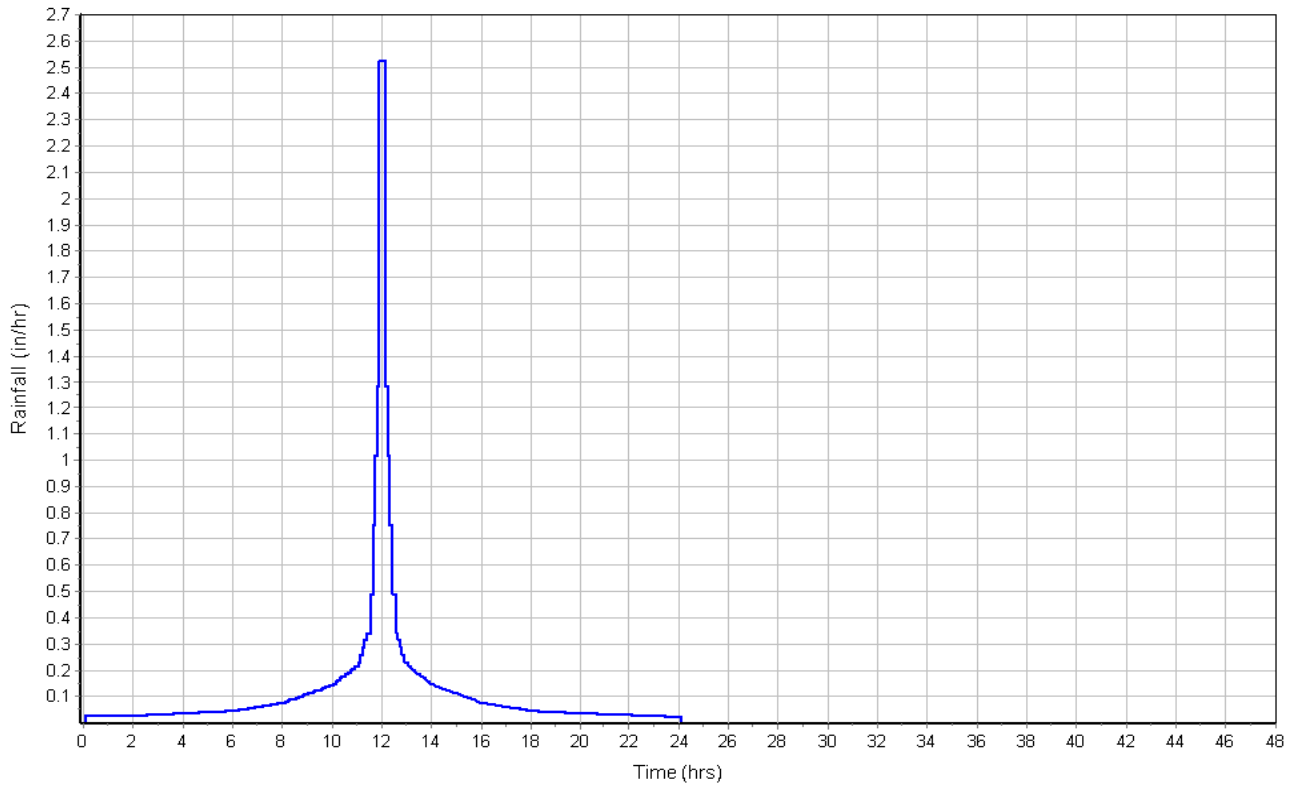

**Runoff Hydrograph**

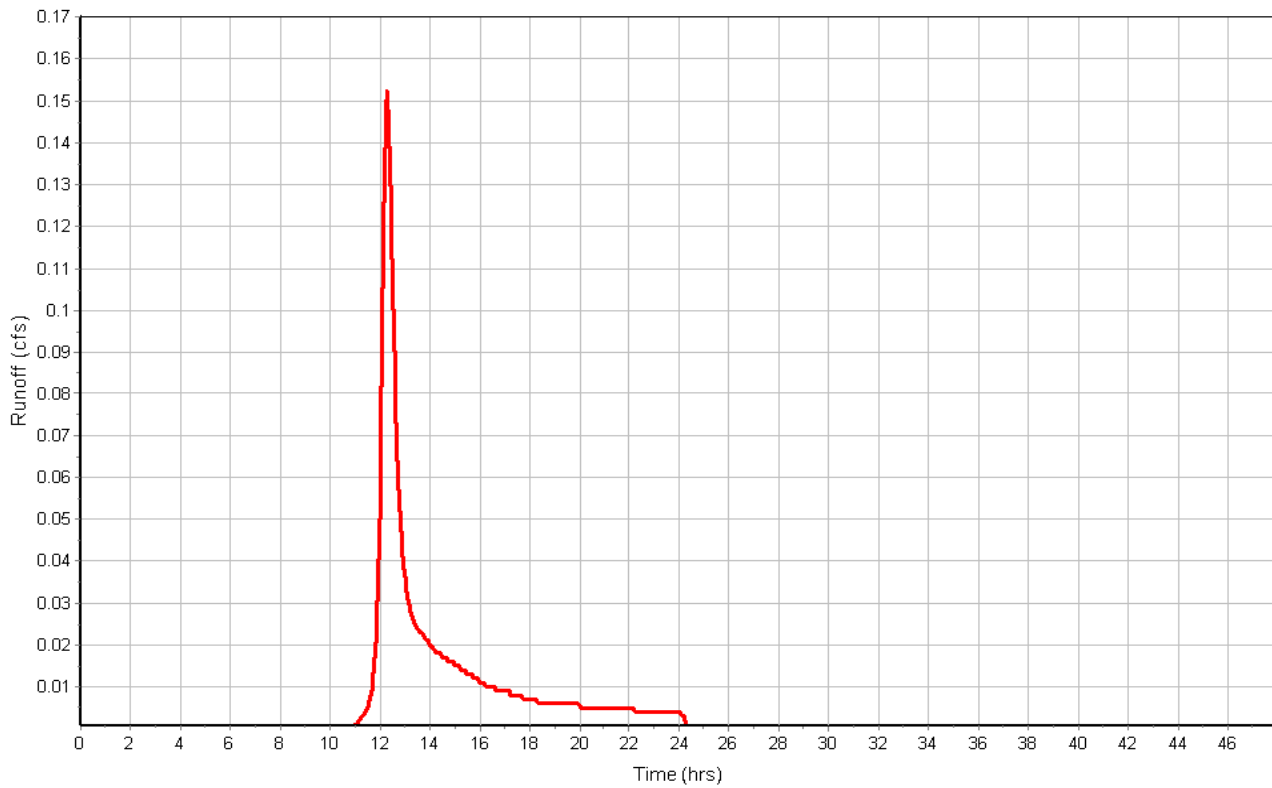

**Subbasin : CulvertDrainageArea**

**Input Data**

Area (ac) ..... 0.68  
Weighted Curve Number ..... 75.00  
Rain Gage ID ..... Rain Gage-01

**Composite Curve Number**

Soil/Surface Description	Area (acres)	Soil Group	Curve Number
-	0.68	-	75.00
Composite Area & Weighted CN	0.68		75.00

**Time of Concentration**

User-Defined TOC override (minutes): 5

**Subbasin Runoff Results**

Total Rainfall (in) ..... 3.00  
Total Runoff (in) ..... 0.96  
Peak Runoff (cfs) ..... 0.67  
Weighted Curve Number ..... 75.00  
Time of Concentration (days hh:mm:ss) ..... 0 00:05:00

Subbasin : CulvertDrainageArea

Rainfall Intensity Graph

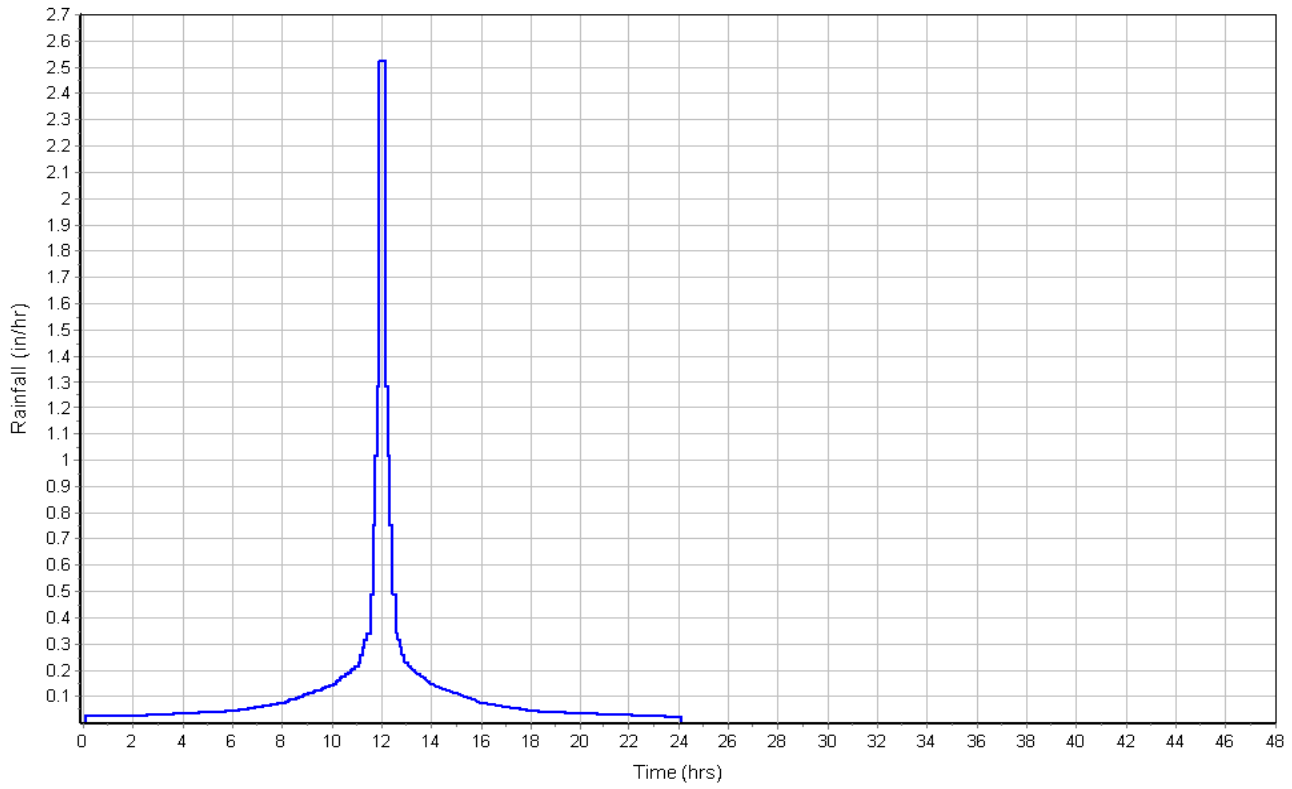

Runoff Hydrograph

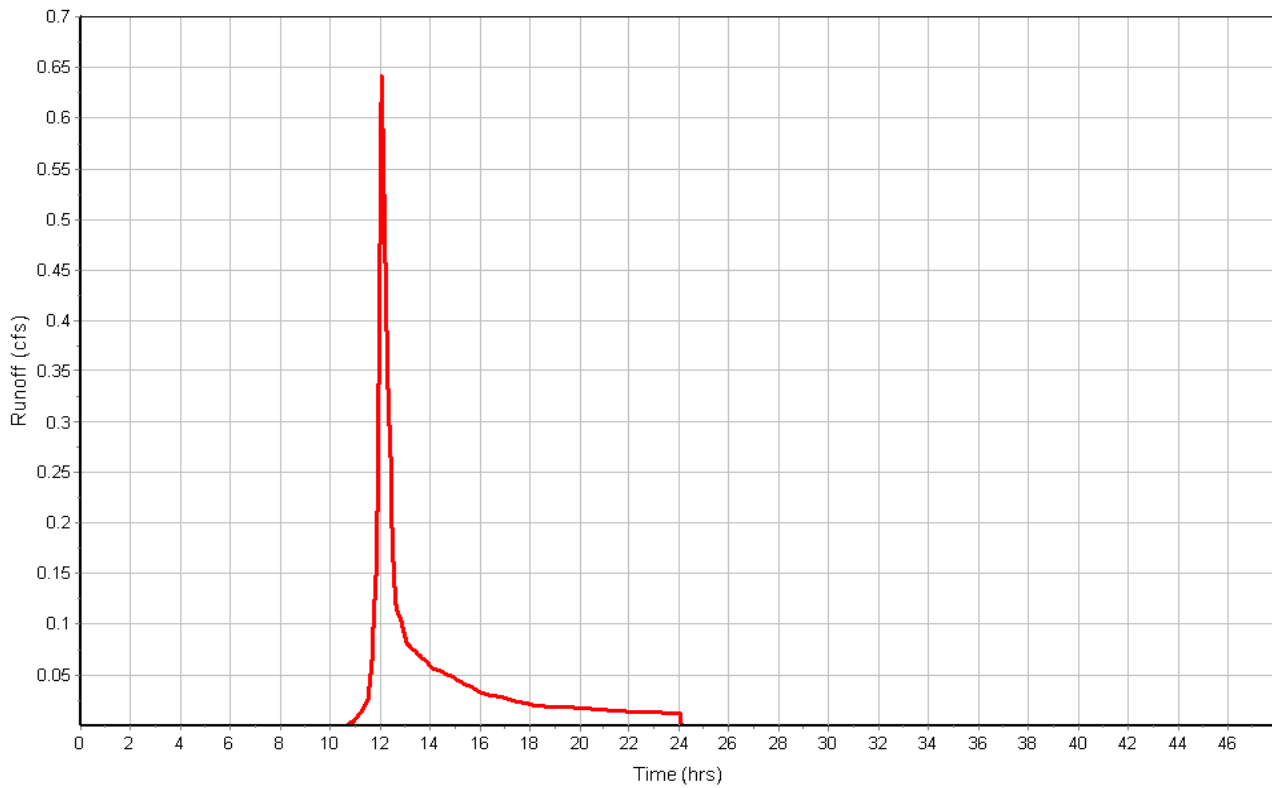



**Subbasin : D**

**Input Data**

Area (ac) ..... 0.12  
 Weighted Curve Number ..... 77.00  
 Rain Gage ID ..... Rain Gage-01

**Composite Curve Number**

Soil/Surface Description	Area (acres)	Soil Group	Curve Number
Woods, Good	0.12	D	77.00
Composite Area & Weighted CN	0.12		77.00

**Time of Concentration**

Sheet Flow Computations	Subarea	Subarea	Subarea
	A	B	C
Manning's Roughness :	.4	0.00	0.00
Flow Length (ft) :	36	0.00	0.00
Slope (%) :	5.55	0.00	0.00
2 yr, 24 hr Rainfall (in) :	3.00	0.00	0.00
Velocity (ft/sec) :	0.09	0.00	0.00
Computed Flow Time (min) :	6.51	0.00	0.00
Total TOC (min) .....	6.51		

**Subbasin Runoff Results**

Total Rainfall (in) ..... 3.00  
 Total Runoff (in) ..... 1.07  
 Peak Runoff (cfs) ..... 0.13  
 Weighted Curve Number ..... 77.00  
 Time of Concentration (days hh:mm:ss) ..... 0 00:06:31

**Subbasin : D**

**Rainfall Intensity Graph**

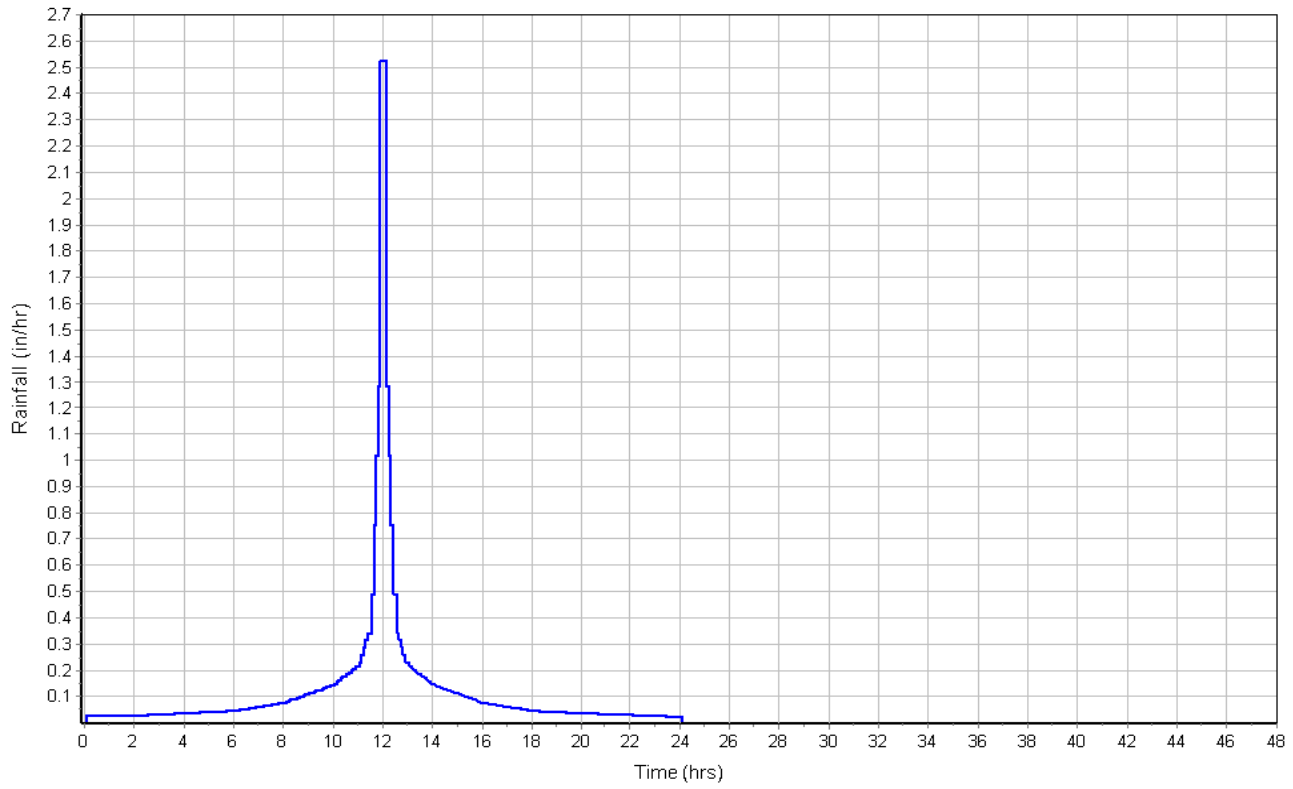

**Runoff Hydrograph**

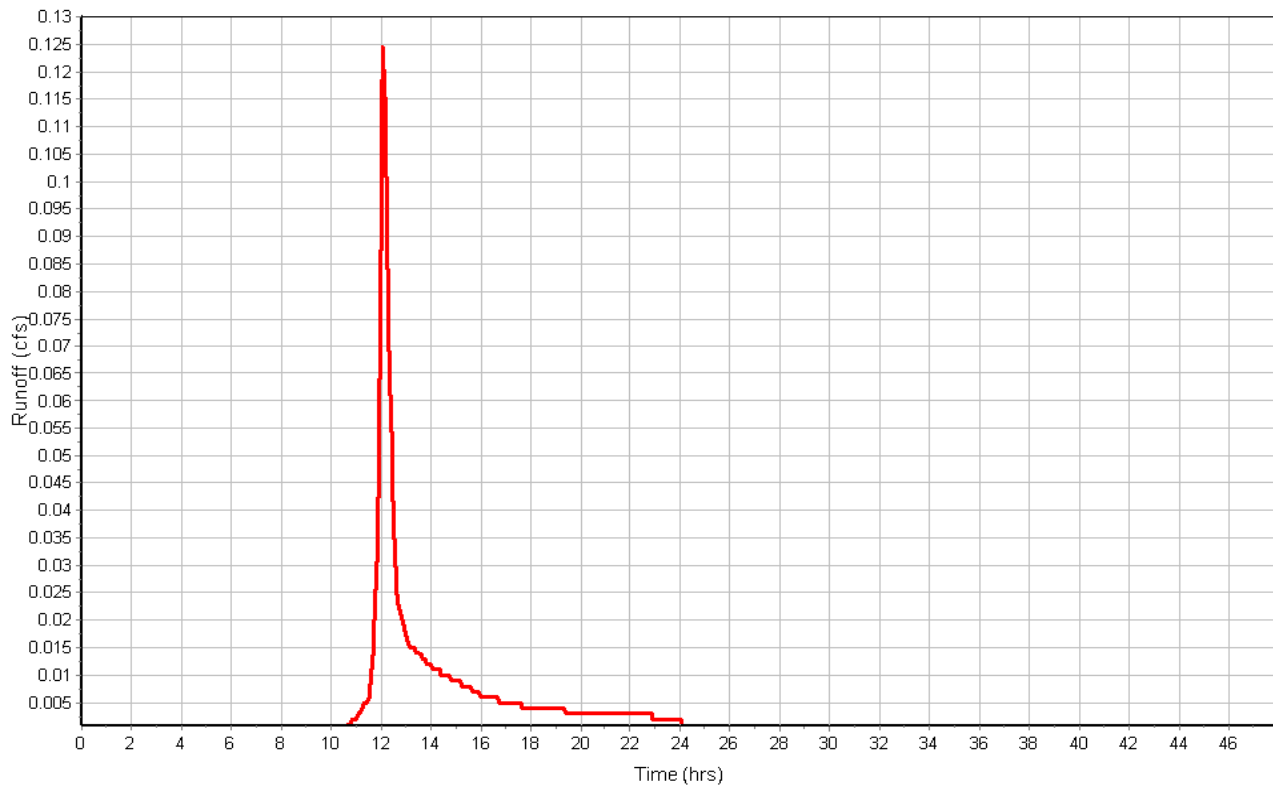

## Junction Input

Element ID	Invert Elevation (ft)	Ground/Rim (Max) Elevation (ft)
CulvertInlet	181.00	184.00
Out_B1andB2	176.00	6.00

## Junction Results

Element ID	Peak Inflow	Max HGL Elevation	Max HGL Depth	Min Freeboard	Average HGL Elevation	Time of Max HGL Occurrence
	(cfs)	(ft)	(ft)	(ft)	(ft)	(days hh:mm)
CulvertInlet	0.64	181.29	0.29	2.71	181.02	0 12:10
Out_B1andB2	2.06	176.00	0.00	0.00	176.00	0 00:00

## Pipe Input

Element ID	Length (ft)	Inlet Invert Elevation (ft)	Outlet Invert Elevation (ft)	Average Pipe Slope (%)	Pipe Shape	Pipe Diameter or Height (in)	Pipe Width (in)	Manning's Roughness
Direct_to_OutB	1715.96	0.00	0.00	0.0000	Dummy	0.000	0.000	0.0150
Link-03	45.00	181.00	180.55	1.0000	CIRCULAR	15.000	15.000	0.0150

## Pipe Results

Element ID	Peak Flow (cfs)	Time of Peak Flow Occurrence (days hh:mm)	Design Flow Capacity (cfs)	Peak Flow Velocity (ft/sec)	Peak Flow Depth (ft)
Direct_to_OutB	2.06	0 13:00	0.00	0.00	0.00
Link-03	0.64	0 12:10	5.60	3.04	0.29

## Project Description

File Name ..... Proposed Conditions\_SMT.SPF

## Project Options

Flow Units ..... CFS  
 Elevation Type ..... Elevation  
 Hydrology Method ..... SCS TR-55  
 Time of Concentration (TOC) Method ..... SCS TR-55  
 Link Routing Method ..... Kinematic Wave  
 Enable Overflow Ponding at Nodes ..... YES  
 Skip Steady State Analysis Time Periods ..... NO

## Analysis Options

Start Analysis On ..... Aug 15, 2017 00:00:00  
 End Analysis On ..... Aug 17, 2017 00:00:00  
 Start Reporting On ..... Aug 15, 2017 00:00:00  
 Antecedent Dry Days ..... 0 days  
 Runoff (Dry Weather) Time Step ..... 0 01:00:00 days hh:mm:ss  
 Runoff (Wet Weather) Time Step ..... 0 00:05:00 days hh:mm:ss  
 Reporting Time Step ..... 0 00:05:00 days hh:mm:ss  
 Routing Time Step ..... 30 seconds

## Number of Elements

	Qty
Rain Gages .....	1
Subbasins.....	6
Nodes.....	7
<i>Junctions</i> .....	2
<i>Outfalls</i> .....	5
<i>Flow Diversions</i> .....	0
<i>Inlets</i> .....	0
<i>Storage Nodes</i> .....	0
Links.....	2
<i>Channels</i> .....	0
<i>Pipes</i> .....	2
<i>Pumps</i> .....	0
<i>Orifices</i> .....	0
<i>Weirs</i> .....	0
<i>Outlets</i> .....	0
Pollutants .....	0
Land Uses .....	0

## Rainfall Details

SN	Rain Gage ID	Data Source	Data Source ID	Rainfall Type	Rain Units	State	County	Return Period (years)	Rainfall Depth (inches)	Rainfall Distribution
1	Rain Gage-01	Time Series	TS-10	Cumulative	inches	Maine	Cumberland (Southeast)	10	4.70	SCS Type III 24-hr

## Subbasin Summary

Subbasin ID	Area (ac)	Weighted Curve Number	Total Rainfall (in)	Total Runoff (in)	Total Runoff Volume (ac-in)	Peak Runoff (cfs)	Time of Concentration (days hh:mm:ss)
A	3.95	74.46	4.70	2.16	8.55	5.71	0 00:29:55
B-1	2.55	66.95	4.70	1.59	4.06	4.05	0 00:07:01
B-2	7.03	70.54	4.70	1.86	13.05	5.14	0 01:17:51
C	0.21	75.29	4.70	2.23	0.47	0.37	0 00:20:30
CulvertDrainageArea	0.68	75.00	4.70	2.21	1.50	1.58	0 00:05:00
D	0.12	77.00	4.70	2.37	0.28	0.30	0 00:06:30



## Node Summary

Element ID	Element Type	Invert Elevation	Peak Inflow
		(ft)	(cfs)
CulvertInlet	Junction	181.00	1.54
Out_B1andB2	Junction	176.00	5.73
CulvertOutlet	Outfall	180.35	1.53
OUT-A	Outfall	180.00	5.67
OUT-B	Outfall	176.00	5.73
OUT-C	Outfall	178.00	0.37
OUT-D	Outfall	190.82	0.29

## Link Summary

Element ID	Element Type	From (Inlet) Node	To (Outlet) Node	Length (ft)	Inlet Invert Elevation (ft)	Outlet Invert Elevation (ft)	Average Slope (%)	Diameter or Height (in)	Manning's Roughness	Peak Flow (cfs)	Design Flow Capacity (cfs)	Peak Flow Velocity (ft/sec)	Peak Flow Depth (ft)
Direct_to_OutB	Pipe	Out_B1andB2	OUT-B	1715.96	0.00	0.00	0.0000	0.000	0.0150	5.73	0.00	0.00	0.00
Link-03	Pipe	CulvertInlet	CulvertOutlet	45.00	181.00	180.55	1.0000	15.000	0.0150	1.53	5.60	3.89	0.45

## Subbasin Hydrology

### Subbasin : A

#### Input Data

Area (ac) ..... 3.95  
Weighted Curve Number ..... 74.46  
Rain Gage ID ..... Rain Gage-01

#### Composite Curve Number

Soil/Surface Description	Area (acres)	Soil Group	Curve Number
Woods, Good	0.33	D	77.00
Gravel roads	0.10	D	91.00
> 75% grass cover, Good	0.38	D	80.00
Brush, Good	3.14	D	73.00
Composite Area & Weighted CN	3.95		74.46

#### Time of Concentration

TOC Method : SCS TR-55

Sheet Flow Equation :

$$T_c = (0.007 * ((n * L_f)^{0.8})) / ((P^{0.5}) * (S_f^{0.4}))$$

Where :

T<sub>c</sub> = Time of Concentration (hr)  
n = Manning's roughness  
L<sub>f</sub> = Flow Length (ft)  
P = 2 yr, 24 hr Rainfall (inches)  
S<sub>f</sub> = Slope (ft/ft)

Shallow Concentrated Flow Equation :

V = 16.1345 \* (S<sub>f</sub><sup>0.5</sup>) (unpaved surface)  
V = 20.3282 \* (S<sub>f</sub><sup>0.5</sup>) (paved surface)  
V = 15.0 \* (S<sub>f</sub><sup>0.5</sup>) (grassed waterway surface)  
V = 10.0 \* (S<sub>f</sub><sup>0.5</sup>) (nearly bare & untilled surface)  
V = 9.0 \* (S<sub>f</sub><sup>0.5</sup>) (cultivated straight rows surface)  
V = 7.0 \* (S<sub>f</sub><sup>0.5</sup>) (short grass pasture surface)  
V = 5.0 \* (S<sub>f</sub><sup>0.5</sup>) (woodland surface)  
V = 2.5 \* (S<sub>f</sub><sup>0.5</sup>) (forest w/heavy litter surface)  
T<sub>c</sub> = (L<sub>f</sub> / V) / (3600 sec/hr)

Where:

T<sub>c</sub> = Time of Concentration (hr)  
L<sub>f</sub> = Flow Length (ft)  
V = Velocity (ft/sec)  
S<sub>f</sub> = Slope (ft/ft)

Channel Flow Equation :

V = (1.49 \* (R<sup>2/3</sup>) \* (S<sub>f</sub><sup>0.5</sup>)) / n  
R = A<sub>q</sub> / W<sub>p</sub>  
T<sub>c</sub> = (L<sub>f</sub> / V) / (3600 sec/hr)

Where :

T<sub>c</sub> = Time of Concentration (hr)  
L<sub>f</sub> = Flow Length (ft)  
R = Hydraulic Radius (ft)  
A<sub>q</sub> = Flow Area (ft<sup>2</sup>)  
W<sub>p</sub> = Wetted Perimeter (ft)  
V = Velocity (ft/sec)  
S<sub>f</sub> = Slope (ft/ft)  
n = Manning's roughness

	Subarea	Subarea	Subarea
	A	B	C
<b>Sheet Flow Computations</b>			
Manning's Roughness :	.4	0.00	0.00
Flow Length (ft) :	45	0.00	0.00
Slope (%) :	50	0.00	0.00
2 yr, 24 hr Rainfall (in) :	3.00	0.00	0.00
Velocity (ft/sec) :	0.23	0.00	0.00
Computed Flow Time (min) :	3.23	0.00	0.00
	Subarea	Subarea	Subarea
	A	B	C
<b>Shallow Concentrated Flow Computations</b>			
Flow Length (ft) :	264	574	0.00
Slope (%) :	.76	.35	0.00
Surface Type :	Grassed waterway	Grass pasture	Unpaved
Velocity (ft/sec) :	1.31	0.41	0.00
Computed Flow Time (min) :	3.36	23.33	0.00
Total TOC (min) .....	29.92		

**Subbasin Runoff Results**

Total Rainfall (in) .....	4.70
Total Runoff (in) .....	2.16
Peak Runoff (cfs) .....	5.71
Weighted Curve Number .....	74.46
Time of Concentration (days hh:mm:ss) .....	0 00:29:55

Subbasin : A

Rainfall Intensity Graph

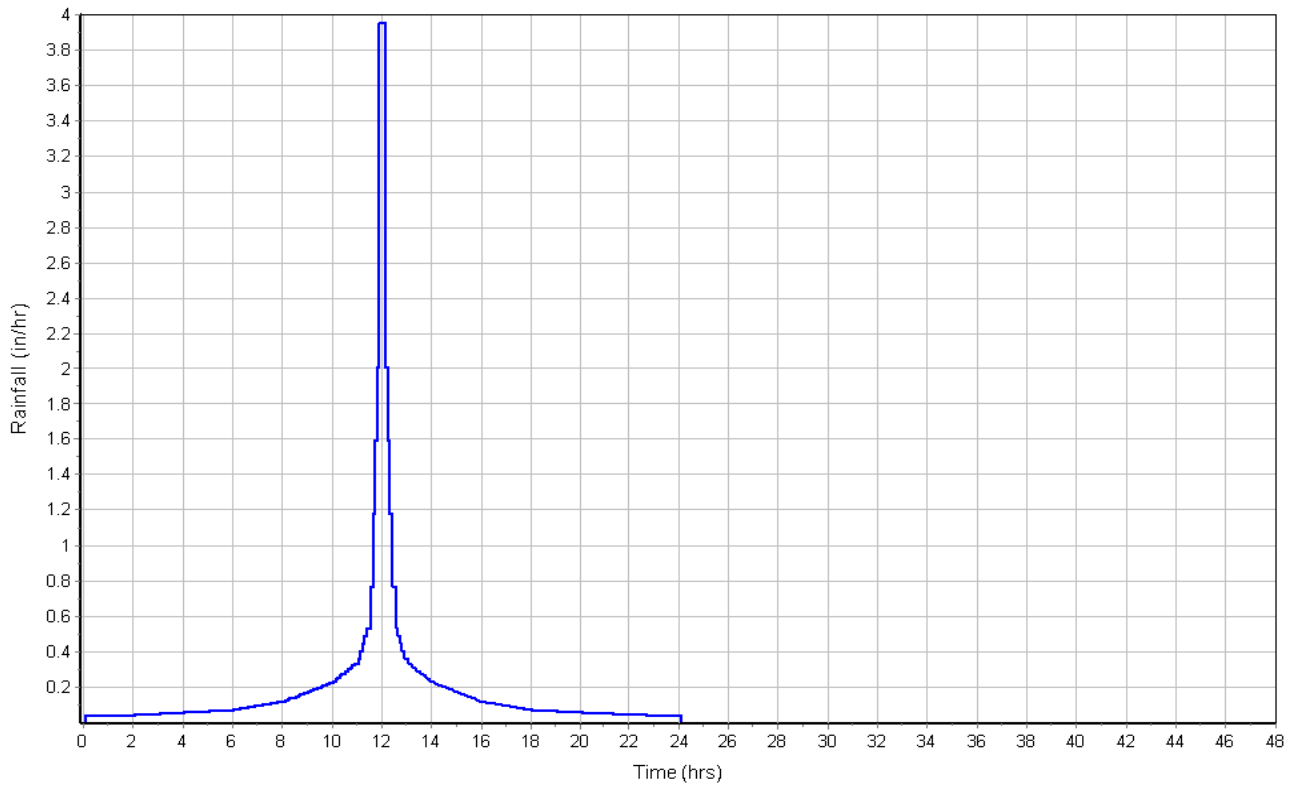

Runoff Hydrograph

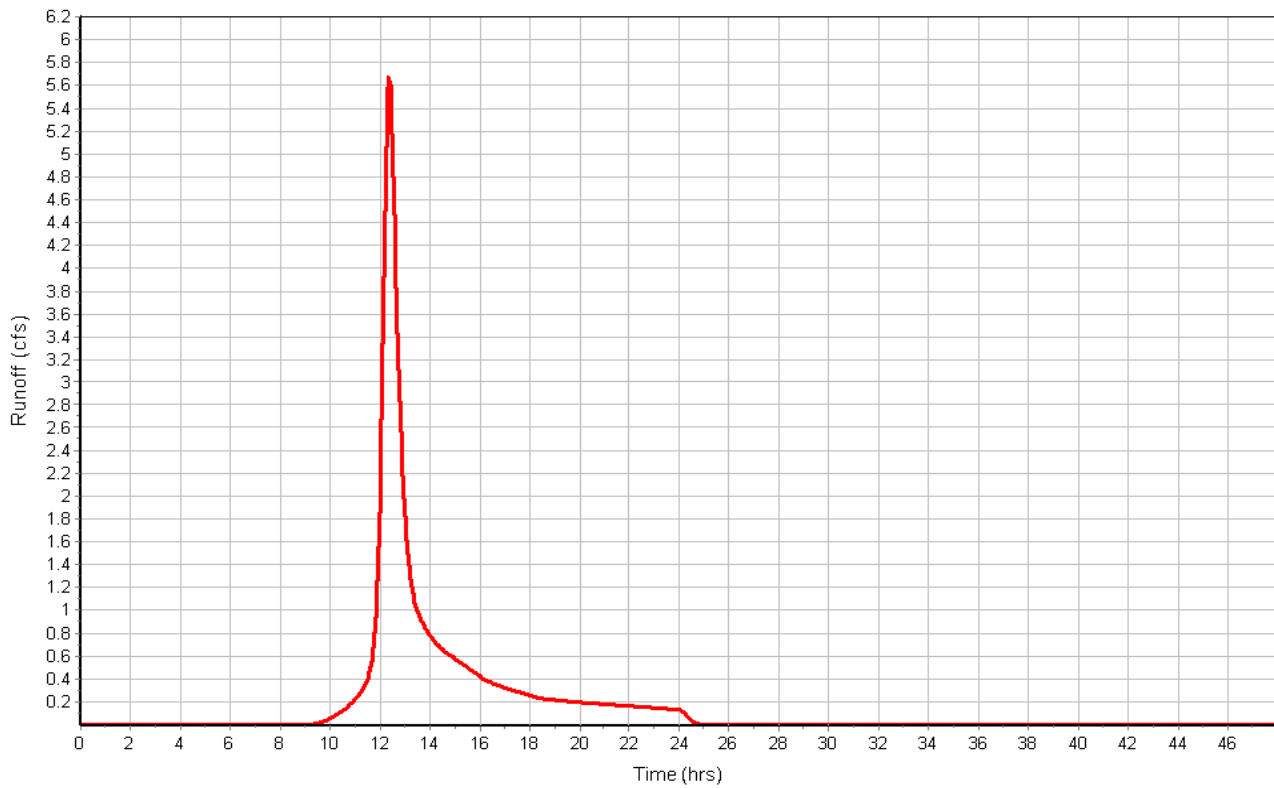

**Subbasin : B-1**

**Input Data**

Area (ac) ..... 2.55  
 Weighted Curve Number ..... 66.95  
 Rain Gage ID ..... Rain Gage-01

**Composite Curve Number**

Soil/Surface Description	Area (acres)	Soil Group	Curve Number
Gravel-Pad	1.88	D	60.00
Rooftops	0.24	D	98.00
> 75% grass cover, Good	0.43	D	80.00
Composite Area & Weighted CN	2.55		66.95

**Time of Concentration**

	Subarea		
	A	B	C
<b>Sheet Flow Computations</b>			
Manning's Roughness :	.4	0.00	0.00
Flow Length (ft) :	38	0.00	0.00
Slope (%) :	50	0.00	0.00
2 yr, 24 hr Rainfall (in) :	3.00	0.00	0.00
Velocity (ft/sec) :	0.22	0.00	0.00
Computed Flow Time (min) :	2.82	0.00	0.00
<b>Shallow Concentrated Flow Computations</b>			
Flow Length (ft) :	385	0.00	0.00
Slope (%) :	1.04	0.00	0.00
Surface Type :	Grassed waterway	Grass pasture	Grass pasture
Velocity (ft/sec) :	1.53	0.00	0.00
Computed Flow Time (min) :	4.19	0.00	0.00
Total TOC (min) .....7.02			

**Subbasin Runoff Results**

Total Rainfall (in) ..... 4.70  
 Total Runoff (in) ..... 1.59  
 Peak Runoff (cfs) ..... 4.05  
 Weighted Curve Number ..... 66.95  
 Time of Concentration (days hh:mm:ss) ..... 0 00:07:01

**Subbasin : B-1**

**Rainfall Intensity Graph**

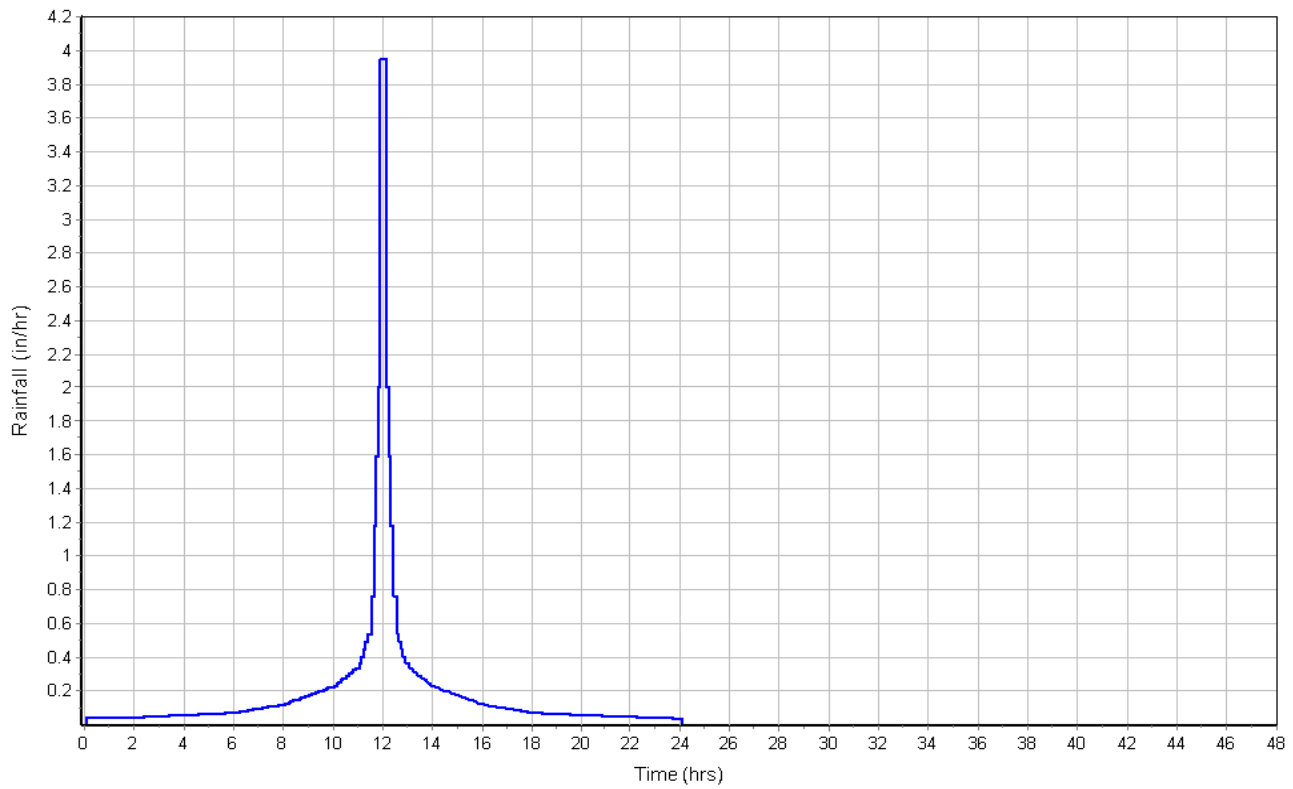

**Runoff Hydrograph**

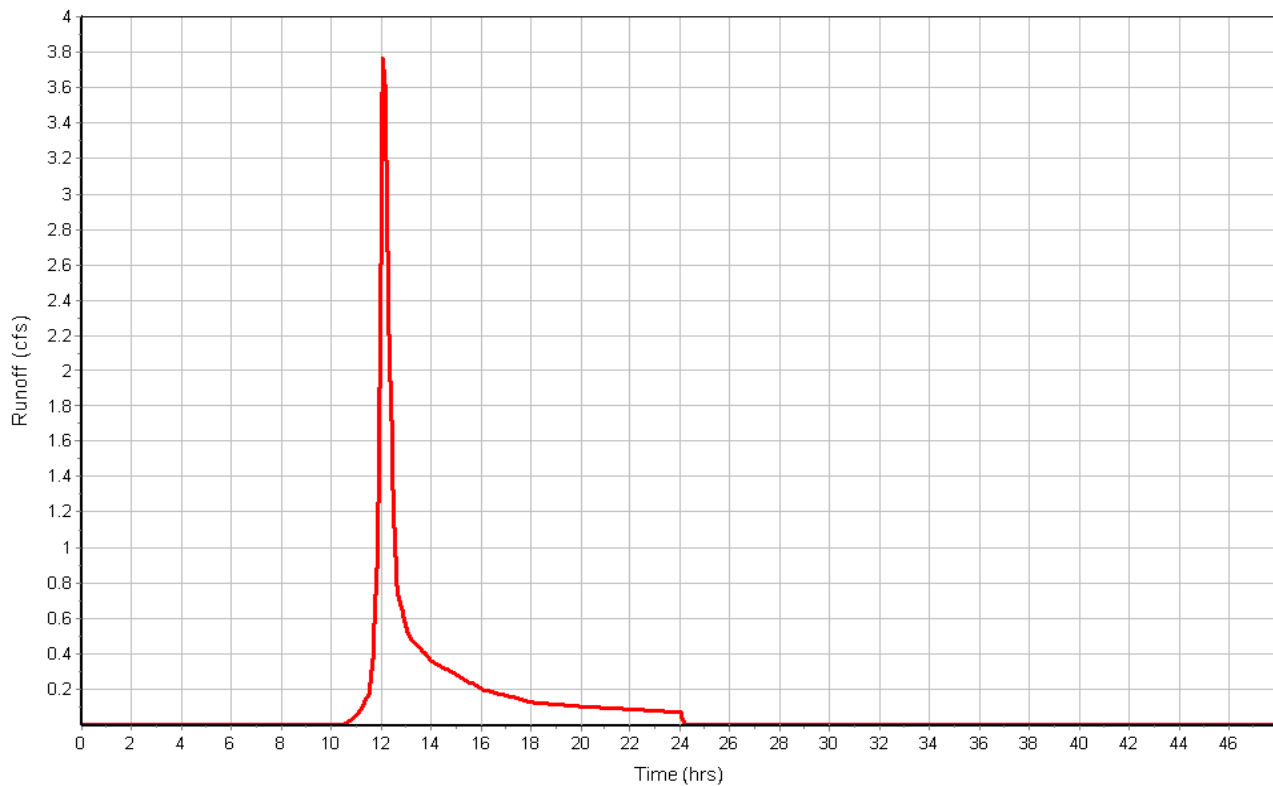

**Subbasin : B-2**

**Input Data**

Area (ac) ..... 7.03  
 Weighted Curve Number ..... 70.54  
 Rain Gage ID ..... Rain Gage-01

**Composite Curve Number**

Soil/Surface Description	Area (acres)	Soil Group	Curve Number
Brush, Good	5.19	D	73.00
Gravel roads	0.05	D	91.00
> 75% grass cover, Good	0.16	D	80.00
Gravel_Pad	1.58	D	60.00
ConcreteFoundations	0.05	D	98.00
Composite Area & Weighted CN	7.03		70.54

**Time of Concentration**

	Subarea A	Subarea B	Subarea C
Sheet Flow Computations			
Manning's Roughness :	.4	0.00	0.00
Flow Length (ft) :	100	0.00	0.00
Slope (%) :	.25	0.00	0.00
2 yr, 24 hr Rainfall (in) :	3.00	0.00	0.00
Velocity (ft/sec) :	0.03	0.00	0.00
Computed Flow Time (min) :	50.95	0.00	0.00
Shallow Concentrated Flow Computations			
Flow Length (ft) :	791	0.00	0.00
Slope (%) :	.5	0.00	0.00
Surface Type :	Grass pasture	Unpaved	Unpaved
Velocity (ft/sec) :	0.49	0.00	0.00
Computed Flow Time (min) :	26.90	0.00	0.00
Total TOC (min) .....	77.86		

**Subbasin Runoff Results**

Total Rainfall (in) ..... 4.70  
 Total Runoff (in) ..... 1.86  
 Peak Runoff (cfs) ..... 5.14  
 Weighted Curve Number ..... 70.54  
 Time of Concentration (days hh:mm:ss) ..... 0 01:17:52



**Subbasin : B-2**

**Rainfall Intensity Graph**

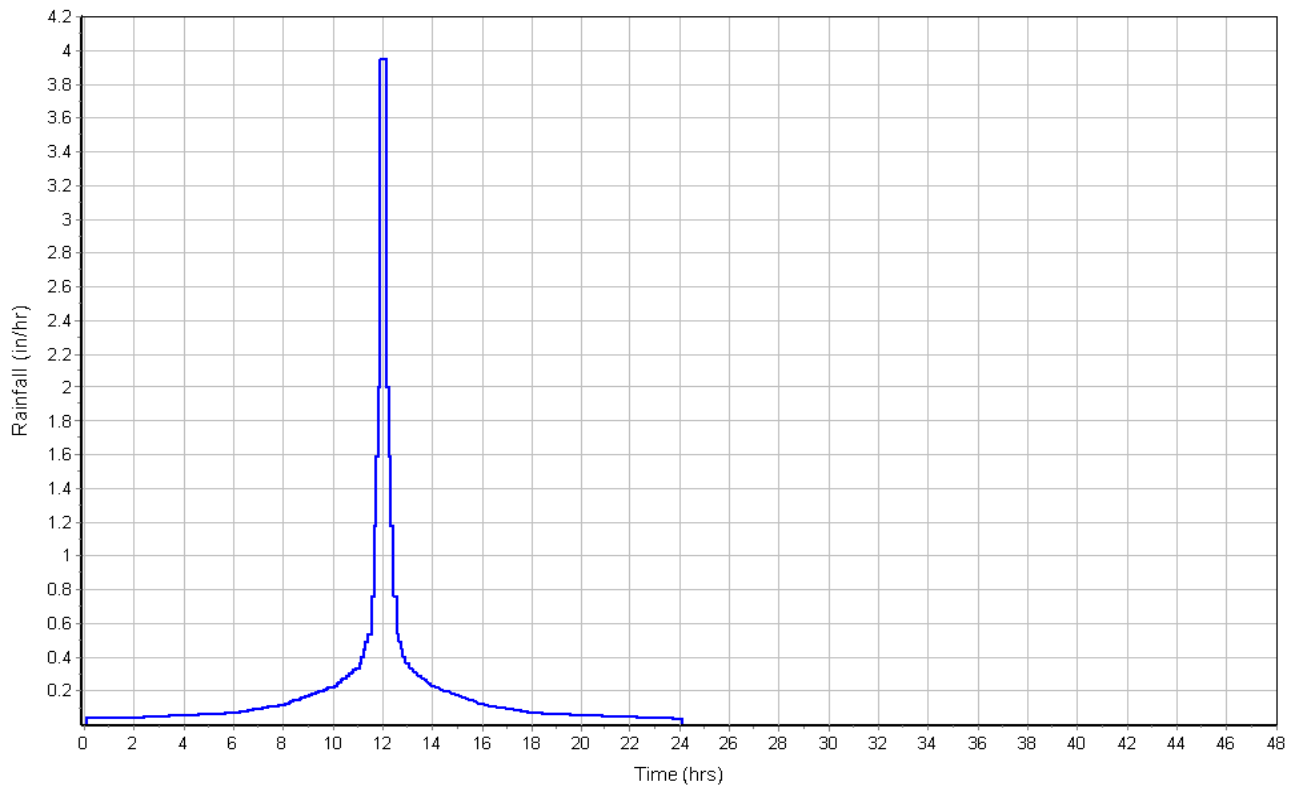

**Runoff Hydrograph**

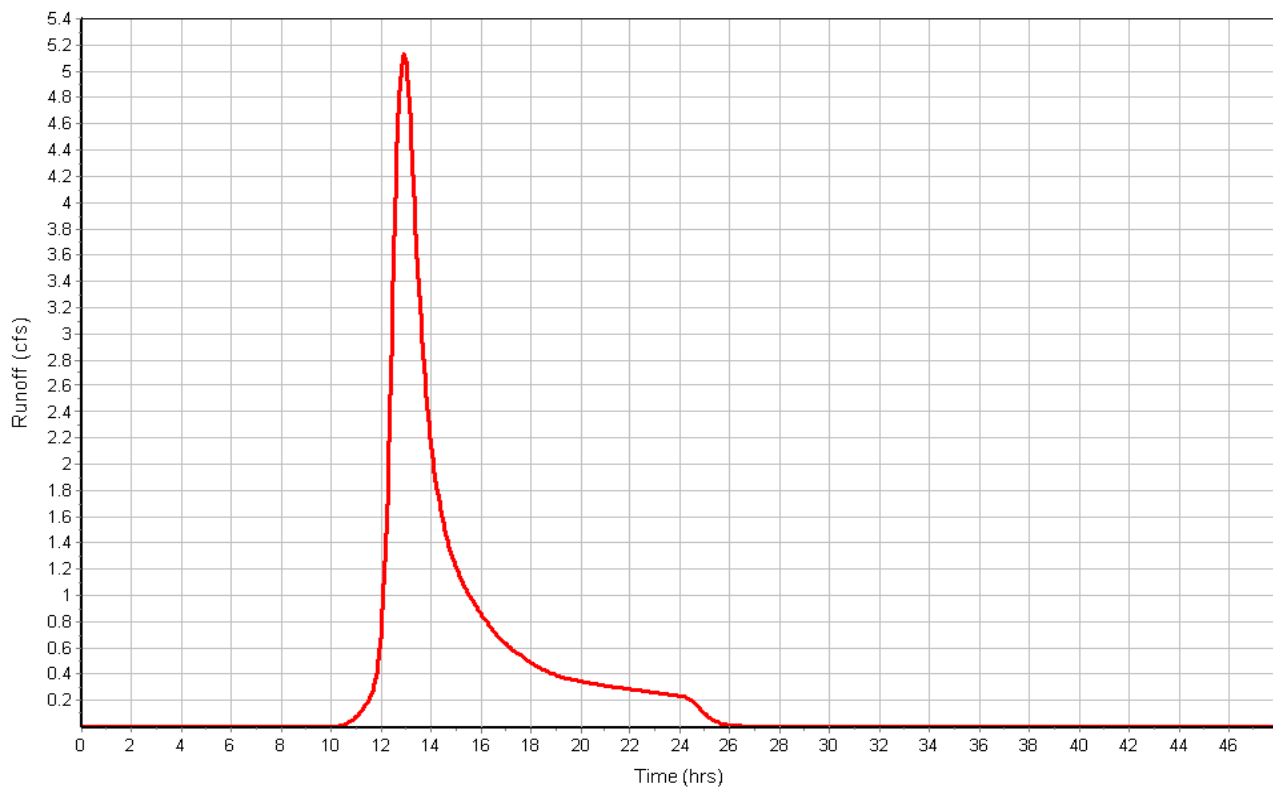

**Subbasin : C**

**Input Data**

Area (ac) ..... 0.21  
 Weighted Curve Number ..... 75.29  
 Rain Gage ID ..... Rain Gage-01

**Composite Curve Number**

Soil/Surface Description	Area (acres)	Soil Group	Curve Number
Woods, Good	0.12	D	77.00
Brush, Good	0.09	D	73.00
Composite Area & Weighted CN	0.21		75.29

**Time of Concentration**

	Subarea A	Subarea B	Subarea C
Sheet Flow Computations			
Manning's Roughness :	.6	0.00	0.00
Flow Length (ft) :	80	0.00	0.00
Slope (%) :	4.31	0.00	0.00
2 yr, 24 hr Rainfall (in) :	3.00	0.00	0.00
Velocity (ft/sec) :	0.07	0.00	0.00
Computed Flow Time (min) :	18.88	0.00	0.00
Shallow Concentrated Flow Computations			
Flow Length (ft) :	182	0.00	0.00
Slope (%) :	7.1	0.00	0.00
Surface Type :	Grass pasture	Unpaved	Unpaved
Velocity (ft/sec) :	1.87	0.00	0.00
Computed Flow Time (min) :	1.62	0.00	0.00
Total TOC (min) .....	20.50		

**Subbasin Runoff Results**

Total Rainfall (in) ..... 4.70  
 Total Runoff (in) ..... 2.23  
 Peak Runoff (cfs) ..... 0.37  
 Weighted Curve Number ..... 75.29  
 Time of Concentration (days hh:mm:ss) ..... 0 00:20:30

**Subbasin : C**

**Rainfall Intensity Graph**

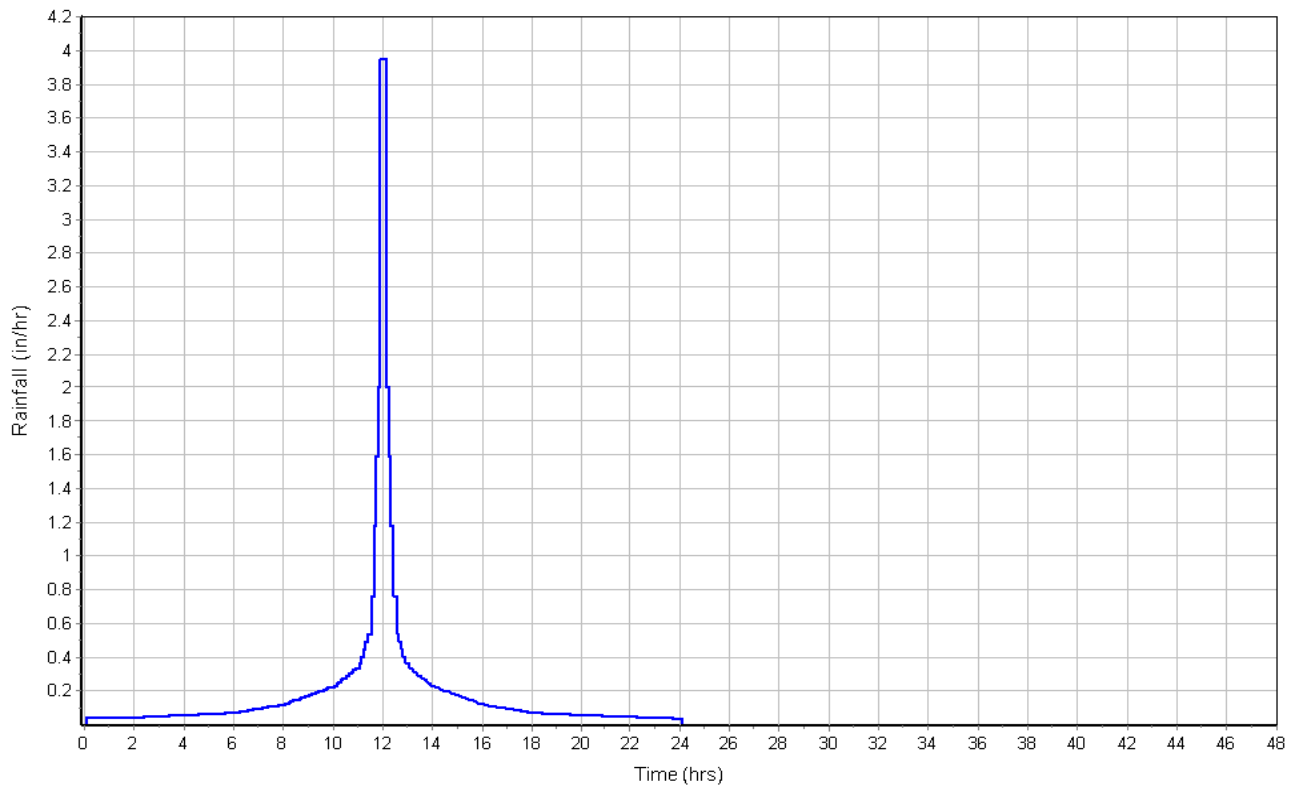

**Runoff Hydrograph**

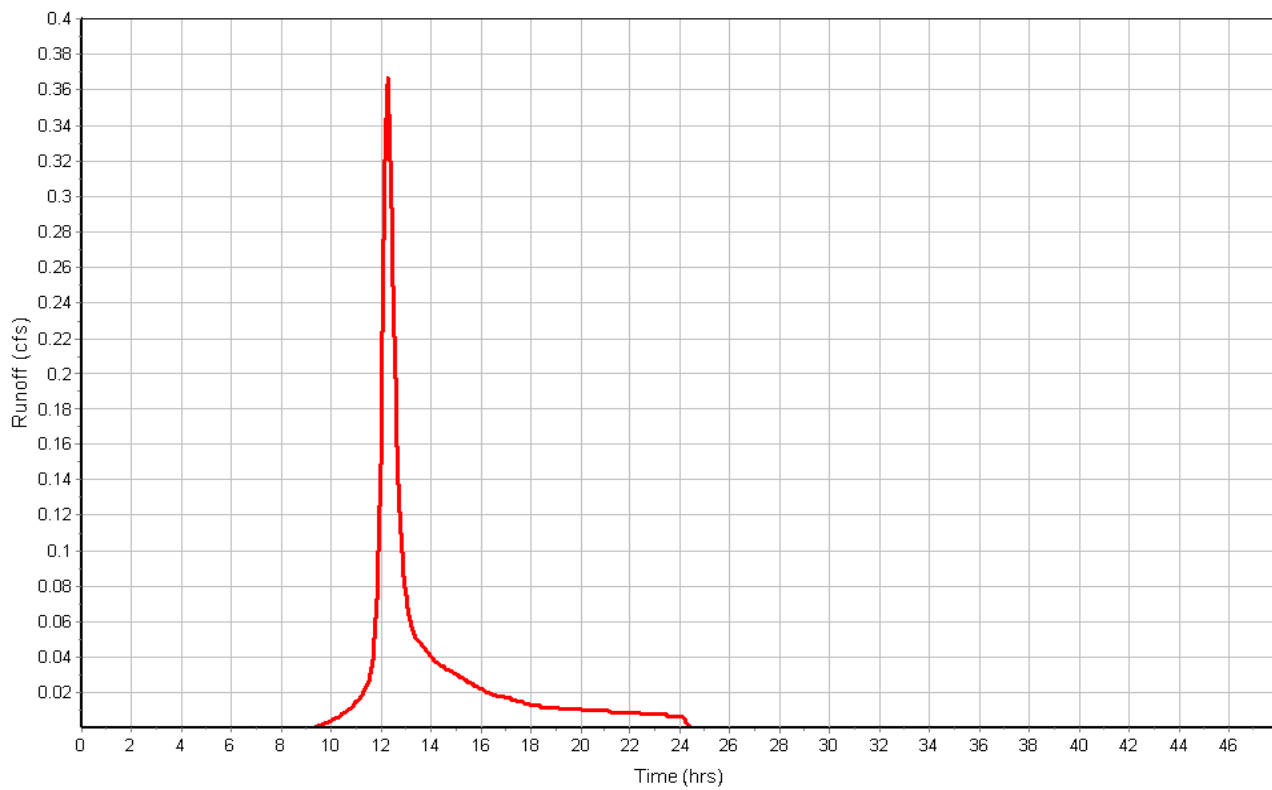

**Subbasin : CulvertDrainageArea**

**Input Data**

Area (ac) ..... 0.68  
Weighted Curve Number ..... 75.00  
Rain Gage ID ..... Rain Gage-01

**Composite Curve Number**

Soil/Surface Description	Area (acres)	Soil Group	Curve Number
-	0.68	-	75.00
Composite Area & Weighted CN	0.68		75.00

**Time of Concentration**

User-Defined TOC override (minutes): 5

**Subbasin Runoff Results**

Total Rainfall (in) ..... 4.70  
Total Runoff (in) ..... 2.21  
Peak Runoff (cfs) ..... 1.58  
Weighted Curve Number ..... 75.00  
Time of Concentration (days hh:mm:ss) ..... 0 00:05:00

**Subbasin : CulvertDrainageArea**

**Rainfall Intensity Graph**

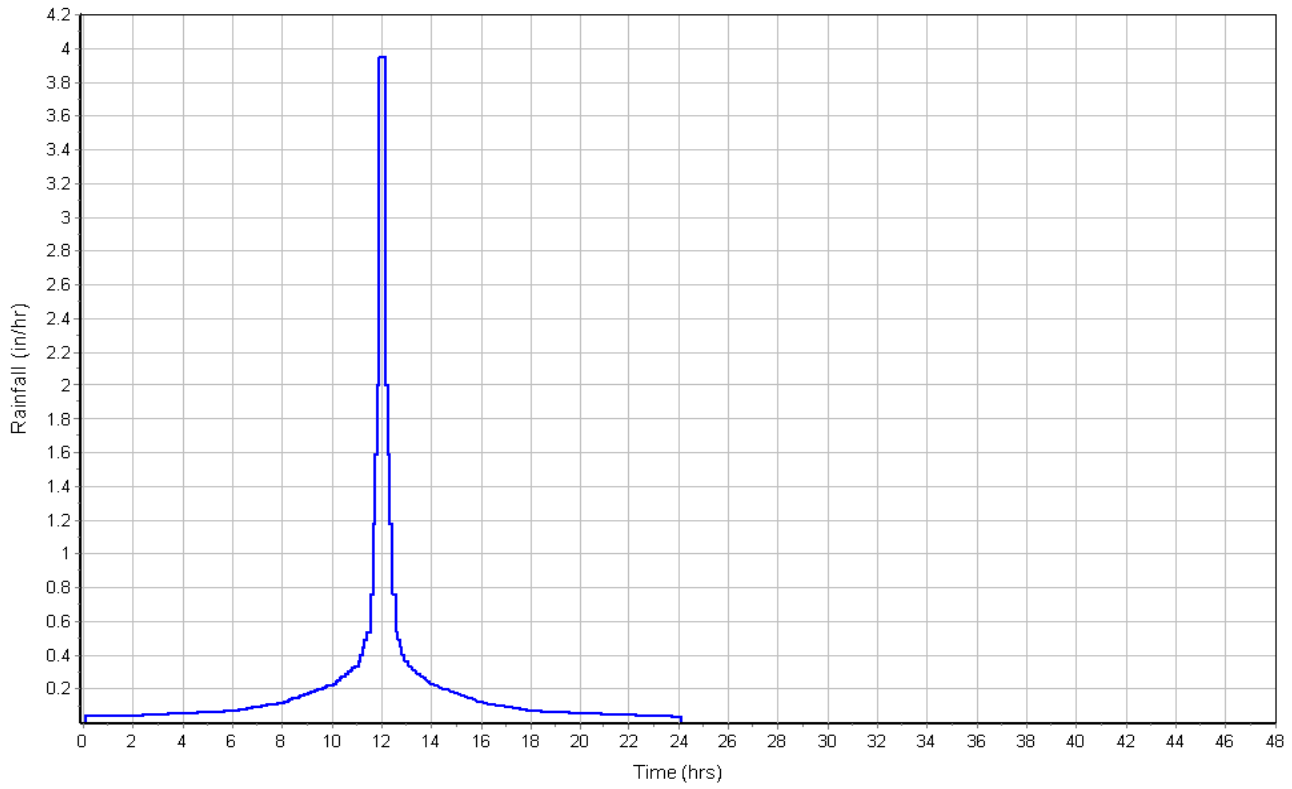

**Runoff Hydrograph**

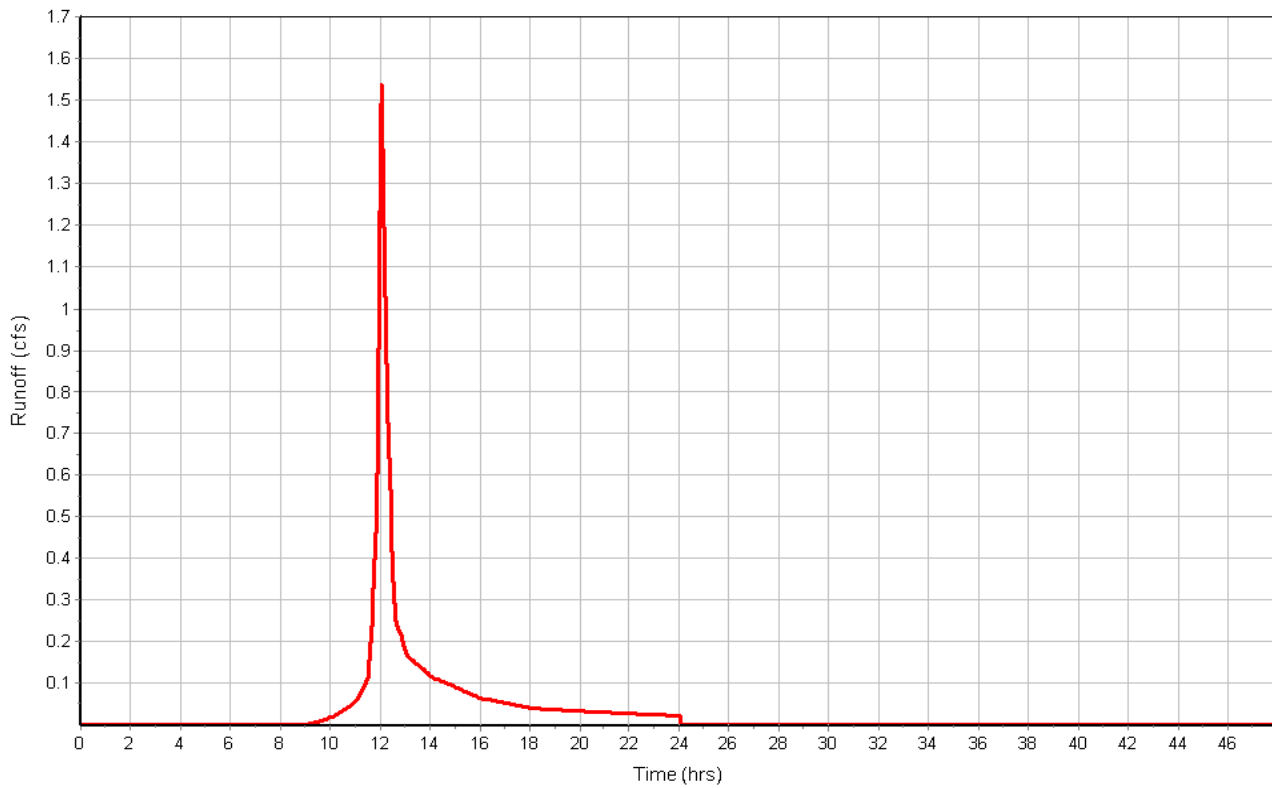

**Subbasin : D**

**Input Data**

Area (ac) ..... 0.12  
 Weighted Curve Number ..... 77.00  
 Rain Gage ID ..... Rain Gage-01

**Composite Curve Number**

Soil/Surface Description	Area (acres)	Soil Group	Curve Number
Woods, Good	0.12	D	77.00
Composite Area & Weighted CN	0.12		77.00

**Time of Concentration**

Sheet Flow Computations	Subarea	Subarea	Subarea
	A	B	C
Manning's Roughness :	.4	0.00	0.00
Flow Length (ft) :	36	0.00	0.00
Slope (%) :	5.55	0.00	0.00
2 yr, 24 hr Rainfall (in) :	3.00	0.00	0.00
Velocity (ft/sec) :	0.09	0.00	0.00
Computed Flow Time (min) :	6.51	0.00	0.00
Total TOC (min) .....	6.51		

**Subbasin Runoff Results**

Total Rainfall (in) ..... 4.70  
 Total Runoff (in) ..... 2.37  
 Peak Runoff (cfs) ..... 0.30  
 Weighted Curve Number ..... 77.00  
 Time of Concentration (days hh:mm:ss) ..... 0 00:06:31

Subbasin : D

Rainfall Intensity Graph

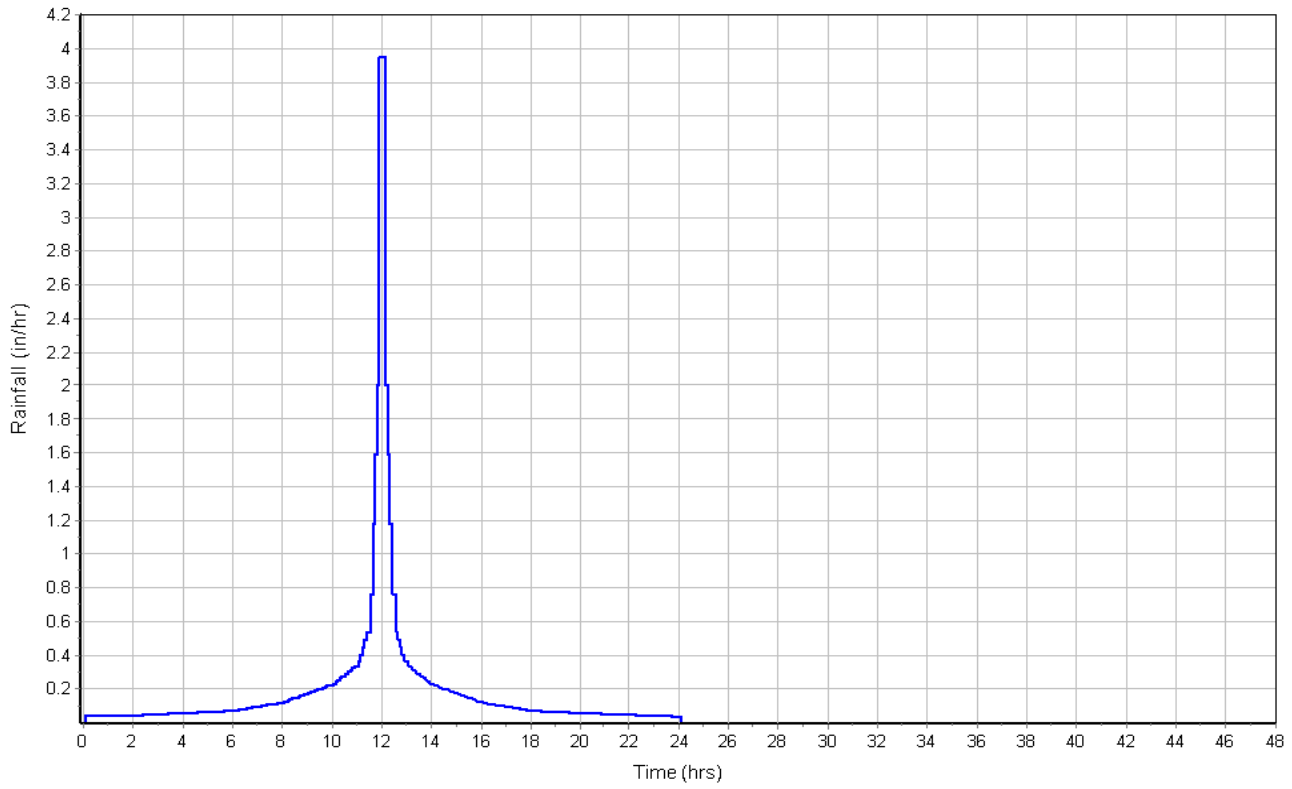

Runoff Hydrograph

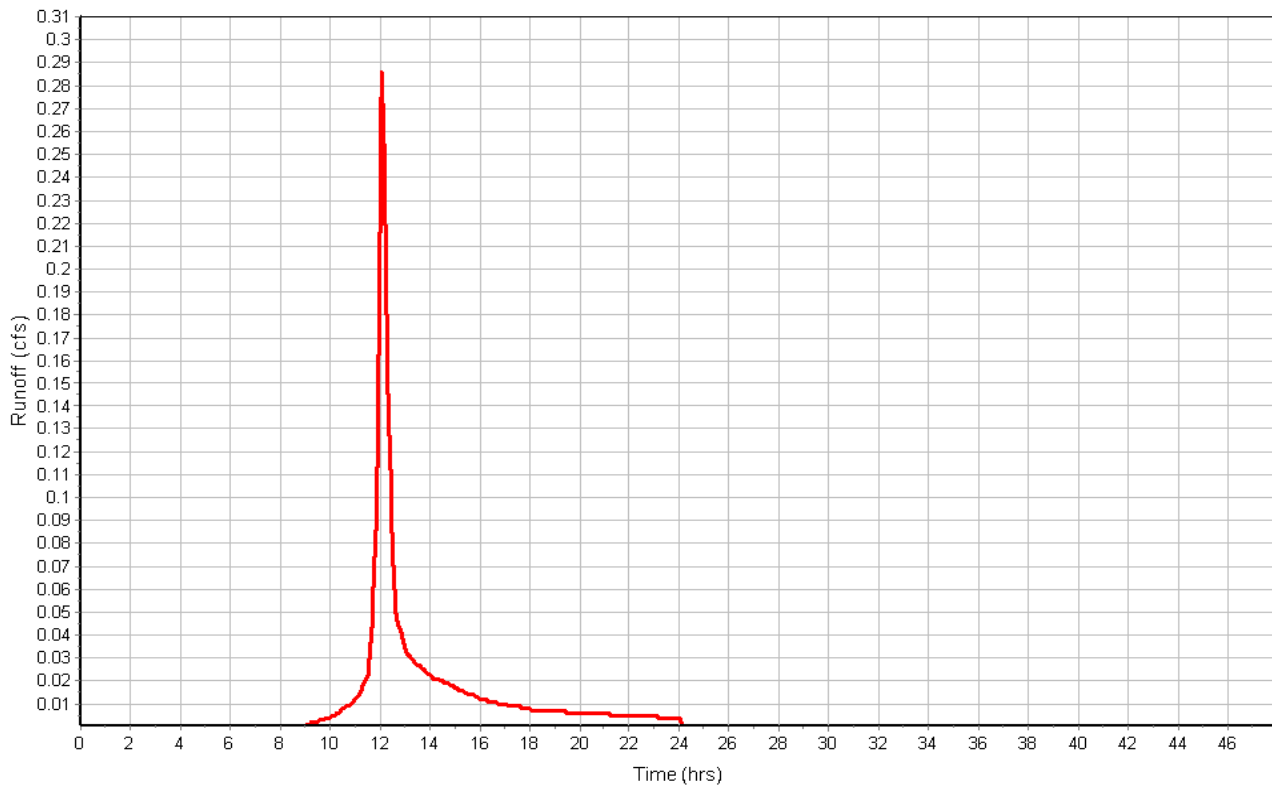

## Junction Input

Element ID	Invert Elevation (ft)	Ground/Rim (Max) Elevation (ft)
CulvertInlet	181.00	184.00
Out_B1andB2	176.00	6.00



## Junction Results

Element ID	Peak Inflow	Max HGL Elevation	Max HGL Depth	Min Freeboard	Average HGL Elevation	Time of Max HGL Occurrence
	(cfs)	(ft)	(ft)	(ft)	(ft)	(days hh:mm)
CulvertInlet	1.54	181.45	0.45	2.55	181.03	0 12:10
Out_B1andB2	5.73	176.00	0.00	0.00	176.00	0 00:00

## Pipe Input

Element ID	Length (ft)	Inlet Invert Elevation (ft)	Outlet Invert Elevation (ft)	Average Pipe Slope (%)	Pipe Shape	Pipe Diameter or Height (in)	Pipe Width (in)	Manning's Roughness
Direct_to_OutB	1715.96	0.00	0.00	0.0000	Dummy	0.000	0.000	0.0150
Link-03	45.00	181.00	180.55	1.0000	CIRCULAR	15.000	15.000	0.0150

## Pipe Results

Element ID	Peak Flow (cfs)	Time of Peak Flow Occurrence (days hh:mm)	Design Flow Capacity (cfs)	Peak Flow Velocity (ft/sec)	Peak Flow Depth (ft)
Direct_to_OutB	5.73	0 13:00	0.00	0.00	0.00
Link-03	1.53	0 12:10	5.60	3.89	0.45

## Project Description

File Name ..... Proposed Conditions\_SMT.SPF

## Project Options

Flow Units ..... CFS  
 Elevation Type ..... Elevation  
 Hydrology Method ..... SCS TR-55  
 Time of Concentration (TOC) Method ..... SCS TR-55  
 Link Routing Method ..... Kinematic Wave  
 Enable Overflow Ponding at Nodes ..... YES  
 Skip Steady State Analysis Time Periods ..... NO

## Analysis Options

Start Analysis On ..... Aug 15, 2017 00:00:00  
 End Analysis On ..... Aug 17, 2017 00:00:00  
 Start Reporting On ..... Aug 15, 2017 00:00:00  
 Antecedent Dry Days ..... 0 days  
 Runoff (Dry Weather) Time Step ..... 0 01:00:00 days hh:mm:ss  
 Runoff (Wet Weather) Time Step ..... 0 00:05:00 days hh:mm:ss  
 Reporting Time Step ..... 0 00:05:00 days hh:mm:ss  
 Routing Time Step ..... 30 seconds

## Number of Elements

	Qty
Rain Gages .....	1
Subbasins.....	6
Nodes.....	7
<i>Junctions</i> .....	2
<i>Outfalls</i> .....	5
<i>Flow Diversions</i> .....	0
<i>Inlets</i> .....	0
<i>Storage Nodes</i> .....	0
Links.....	2
<i>Channels</i> .....	0
<i>Pipes</i> .....	2
<i>Pumps</i> .....	0
<i>Orifices</i> .....	0
<i>Weirs</i> .....	0
<i>Outlets</i> .....	0
Pollutants .....	0
Land Uses .....	0

## Rainfall Details

SN	Rain Gage ID	Data Source	Data Source ID	Rainfall Type	Rain Units	State	County	Return Period (years)	Rainfall Depth (inches)	Rainfall Distribution
1	Rain Gage-01	Time Series	TS-25	Cumulative	inches	Maine	Cumberland (Southeast)	25	5.50	SCS Type III 24-hr

## Subbasin Summary

Subbasin ID	Area (ac)	Weighted Curve Number	Total Rainfall (in)	Total Runoff (in)	Total Runoff Volume (ac-in)	Peak Runoff (cfs)	Time of Concentration (days hh:mm:ss)
A	3.95	74.46	5.50	2.81	11.10	7.47	0 00:29:55
B-1	2.55	66.95	5.50	2.16	5.50	5.55	0 00:07:01
B-2	7.03	70.54	5.50	2.46	17.30	6.91	0 01:17:51
C	0.21	75.29	5.50	2.89	0.61	0.48	0 00:20:30
CulvertDrainageArea	0.68	75.00	5.50	2.86	1.94	2.03	0 00:05:00
D	0.12	77.00	5.50	3.04	0.37	0.38	0 00:06:30

## Node Summary

Element ID	Element Type	Invert Elevation	Peak Inflow
		(ft)	(cfs)
CulvertInlet	Junction	181.00	1.99
Out_B1andB2	Junction	176.00	7.71
CulvertOutlet	Outfall	180.35	1.98
OUT-A	Outfall	180.00	7.44
OUT-B	Outfall	176.00	7.71
OUT-C	Outfall	178.00	0.48
OUT-D	Outfall	190.82	0.37

## Link Summary

Element ID	Element Type	From (Inlet) Node	To (Outlet) Node	Length (ft)	Inlet Invert Elevation (ft)	Outlet Invert Elevation (ft)	Average Slope (%)	Diameter or Height (in)	Manning's Roughness	Peak Flow (cfs)	Design Flow Capacity (cfs)	Peak Flow Velocity (ft/sec)	Peak Flow Depth (ft)
Direct_to_OutB	Pipe	Out_B1andB2	OUT-B	1715.96	0.00	0.00	0.0000	0.000	0.0150	7.71	0.00	0.00	0.00
Link-03	Pipe	CulvertInlet	CulvertOutlet	45.00	181.00	180.55	1.0000	15.000	0.0150	1.98	5.60	4.17	0.51

## Subbasin Hydrology

### Subbasin : A

#### Input Data

Area (ac) ..... 3.95  
Weighted Curve Number ..... 74.46  
Rain Gage ID ..... Rain Gage-01

#### Composite Curve Number

Soil/Surface Description	Area (acres)	Soil Group	Curve Number
Woods, Good	0.33	D	77.00
Gravel roads	0.10	D	91.00
> 75% grass cover, Good	0.38	D	80.00
Brush, Good	3.14	D	73.00
Composite Area & Weighted CN	3.95		74.46

#### Time of Concentration

TOC Method : SCS TR-55

Sheet Flow Equation :

$$T_c = (0.007 * ((n * L_f)^{0.8})) / ((P^{0.5}) * (S_f^{0.4}))$$

Where :

T<sub>c</sub> = Time of Concentration (hr)  
n = Manning's roughness  
L<sub>f</sub> = Flow Length (ft)  
P = 2 yr, 24 hr Rainfall (inches)  
S<sub>f</sub> = Slope (ft/ft)

Shallow Concentrated Flow Equation :

V = 16.1345 \* (S<sub>f</sub><sup>0.5</sup>) (unpaved surface)  
V = 20.3282 \* (S<sub>f</sub><sup>0.5</sup>) (paved surface)  
V = 15.0 \* (S<sub>f</sub><sup>0.5</sup>) (grassed waterway surface)  
V = 10.0 \* (S<sub>f</sub><sup>0.5</sup>) (nearly bare & untilled surface)  
V = 9.0 \* (S<sub>f</sub><sup>0.5</sup>) (cultivated straight rows surface)  
V = 7.0 \* (S<sub>f</sub><sup>0.5</sup>) (short grass pasture surface)  
V = 5.0 \* (S<sub>f</sub><sup>0.5</sup>) (woodland surface)  
V = 2.5 \* (S<sub>f</sub><sup>0.5</sup>) (forest w/heavy litter surface)  
T<sub>c</sub> = (L<sub>f</sub> / V) / (3600 sec/hr)

Where:

T<sub>c</sub> = Time of Concentration (hr)  
L<sub>f</sub> = Flow Length (ft)  
V = Velocity (ft/sec)  
S<sub>f</sub> = Slope (ft/ft)

Channel Flow Equation :

V = (1.49 \* (R<sup>2/3</sup>) \* (S<sub>f</sub><sup>0.5</sup>)) / n  
R = A<sub>q</sub> / W<sub>p</sub>  
T<sub>c</sub> = (L<sub>f</sub> / V) / (3600 sec/hr)

Where :

T<sub>c</sub> = Time of Concentration (hr)  
L<sub>f</sub> = Flow Length (ft)  
R = Hydraulic Radius (ft)  
A<sub>q</sub> = Flow Area (ft<sup>2</sup>)  
W<sub>p</sub> = Wetted Perimeter (ft)  
V = Velocity (ft/sec)  
S<sub>f</sub> = Slope (ft/ft)  
n = Manning's roughness



	Subarea	Subarea	Subarea
	A	B	C
<b>Sheet Flow Computations</b>			
Manning's Roughness :	.4	0.00	0.00
Flow Length (ft) :	45	0.00	0.00
Slope (%) :	50	0.00	0.00
2 yr, 24 hr Rainfall (in) :	3.00	0.00	0.00
Velocity (ft/sec) :	0.23	0.00	0.00
Computed Flow Time (min) :	3.23	0.00	0.00
	Subarea	Subarea	Subarea
	A	B	C
<b>Shallow Concentrated Flow Computations</b>			
Flow Length (ft) :	264	574	0.00
Slope (%) :	.76	.35	0.00
Surface Type :	Grassed waterway	Grass pasture	Unpaved
Velocity (ft/sec) :	1.31	0.41	0.00
Computed Flow Time (min) :	3.36	23.33	0.00
Total TOC (min) .....	29.92		

**Subbasin Runoff Results**

Total Rainfall (in) .....	5.50
Total Runoff (in) .....	2.81
Peak Runoff (cfs) .....	7.47
Weighted Curve Number .....	74.46
Time of Concentration (days hh:mm:ss) .....	0 00:29:55

Subbasin : A

Rainfall Intensity Graph

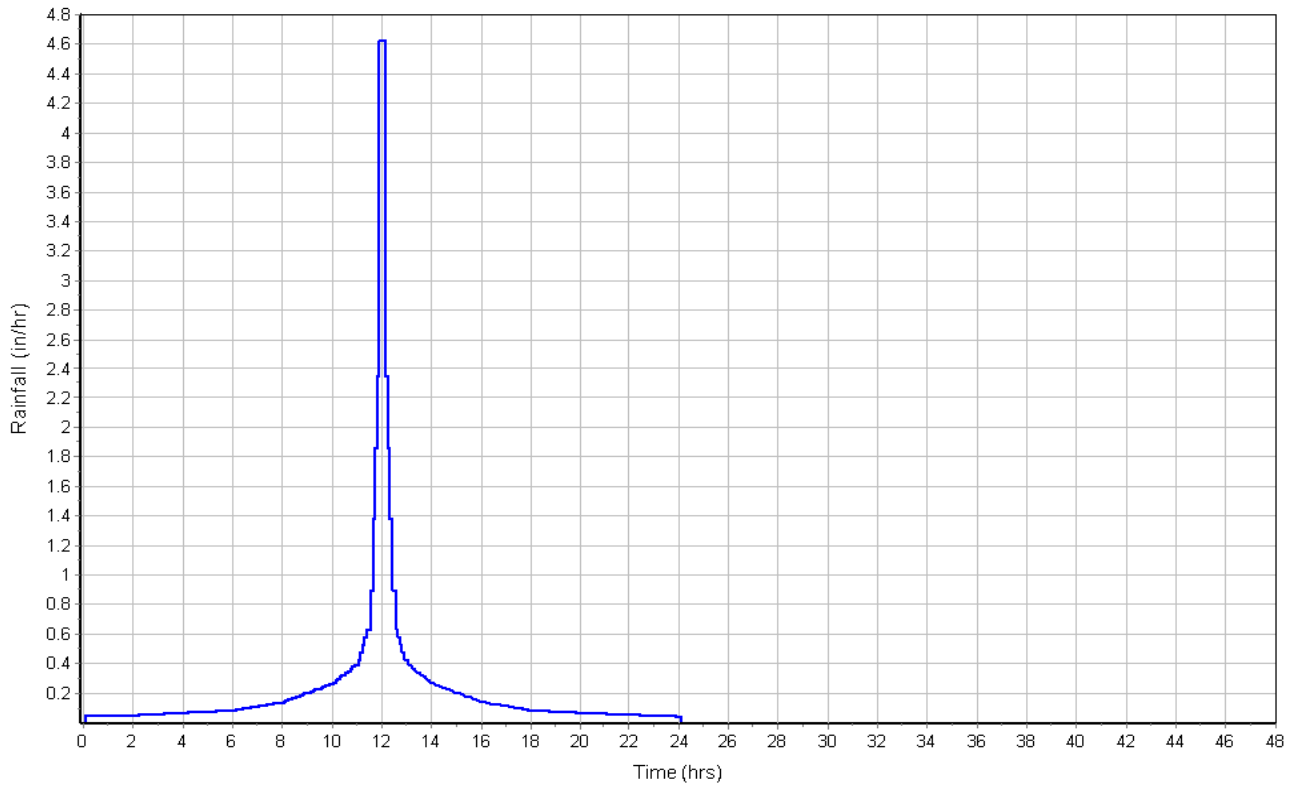

Runoff Hydrograph

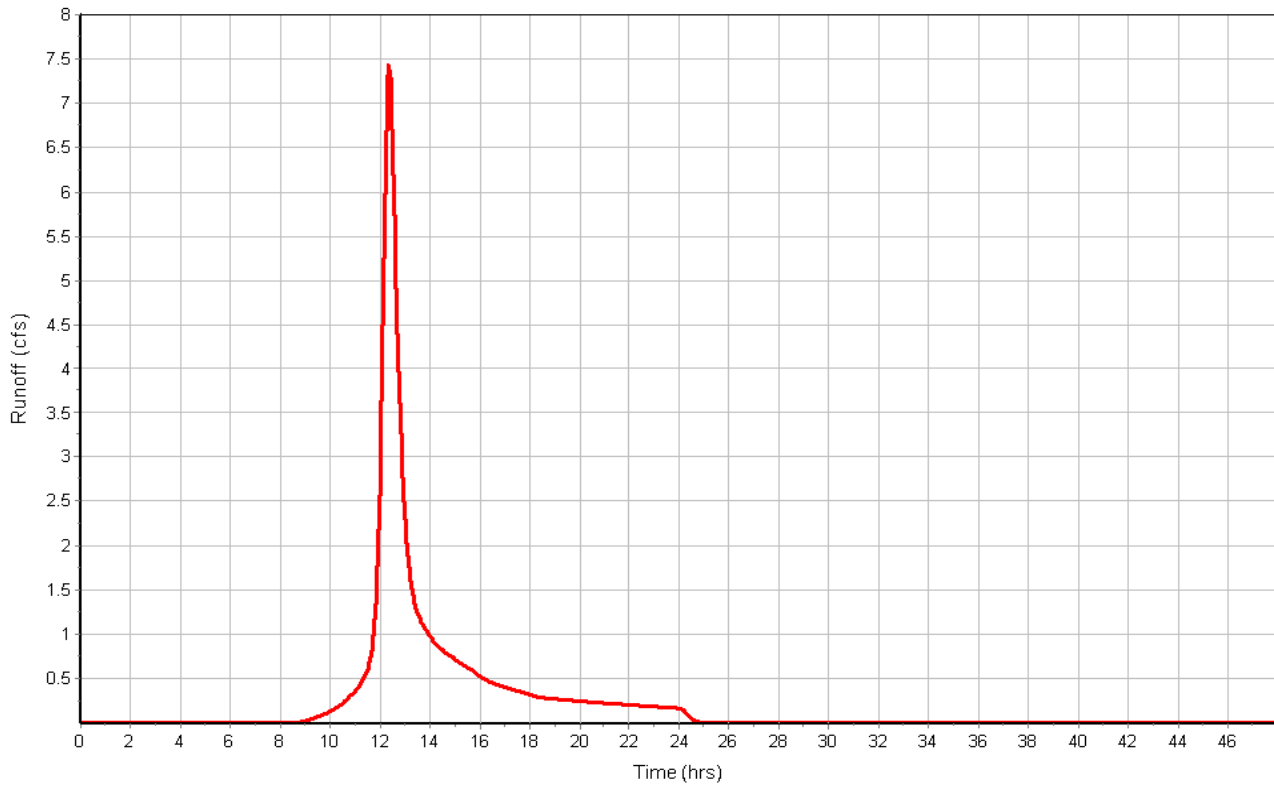

**Subbasin : B-1**

**Input Data**

Area (ac) ..... 2.55  
 Weighted Curve Number ..... 66.95  
 Rain Gage ID ..... Rain Gage-01

**Composite Curve Number**

Soil/Surface Description	Area (acres)	Soil Group	Curve Number
Gravel-Pad	1.88	D	60.00
Rooftops	0.24	D	98.00
> 75% grass cover, Good	0.43	D	80.00
Composite Area & Weighted CN	2.55		66.95

**Time of Concentration**

	Subarea		
	A	B	C
Sheet Flow Computations			
Manning's Roughness :	.4	0.00	0.00
Flow Length (ft) :	38	0.00	0.00
Slope (%) :	50	0.00	0.00
2 yr, 24 hr Rainfall (in) :	3.00	0.00	0.00
Velocity (ft/sec) :	0.22	0.00	0.00
Computed Flow Time (min) :	2.82	0.00	0.00
Shallow Concentrated Flow Computations			
Flow Length (ft) :	385	0.00	0.00
Slope (%) :	1.04	0.00	0.00
Surface Type :	Grassed waterway	Grass pasture	Grass pasture
Velocity (ft/sec) :	1.53	0.00	0.00
Computed Flow Time (min) :	4.19	0.00	0.00
Total TOC (min) .....7.02			

**Subbasin Runoff Results**

Total Rainfall (in) ..... 5.50  
 Total Runoff (in) ..... 2.16  
 Peak Runoff (cfs) ..... 5.55  
 Weighted Curve Number ..... 66.95  
 Time of Concentration (days hh:mm:ss) ..... 0 00:07:01

Subbasin : B-1

Rainfall Intensity Graph

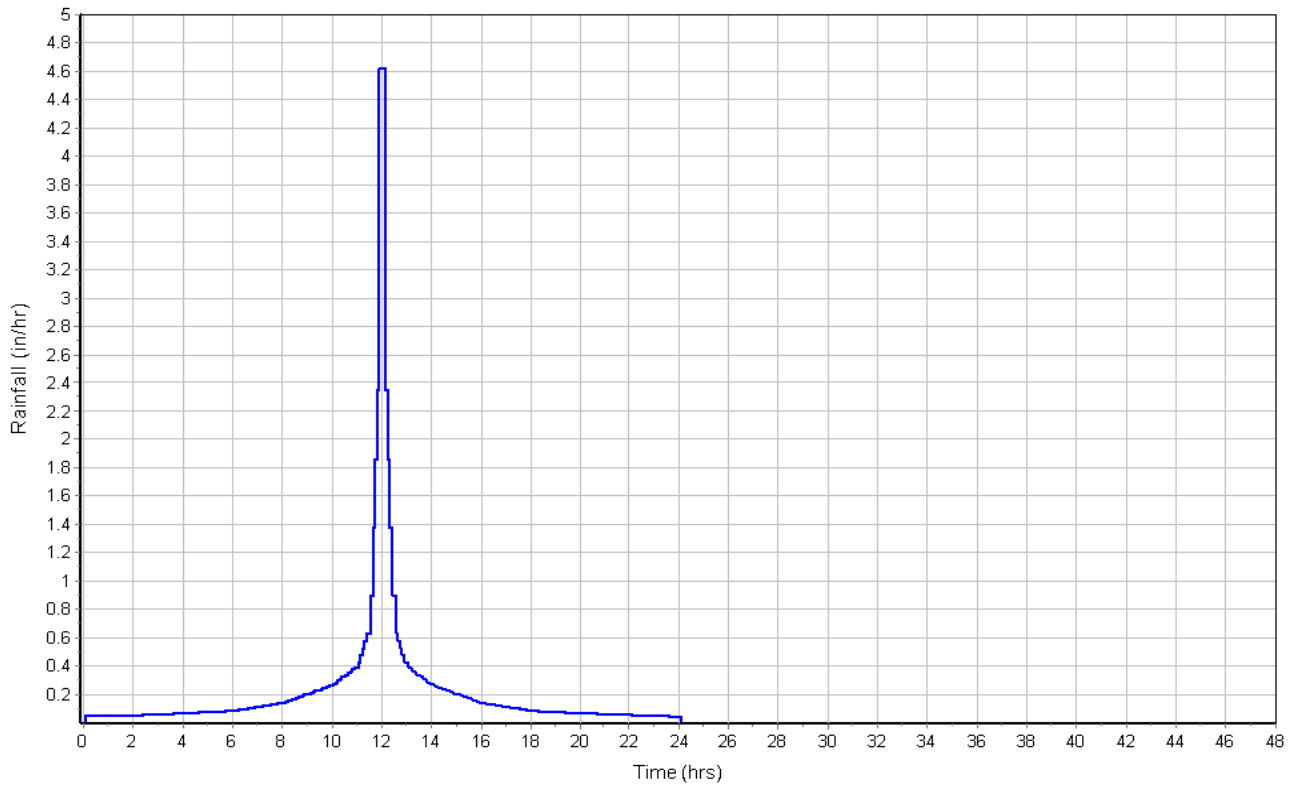

Runoff Hydrograph

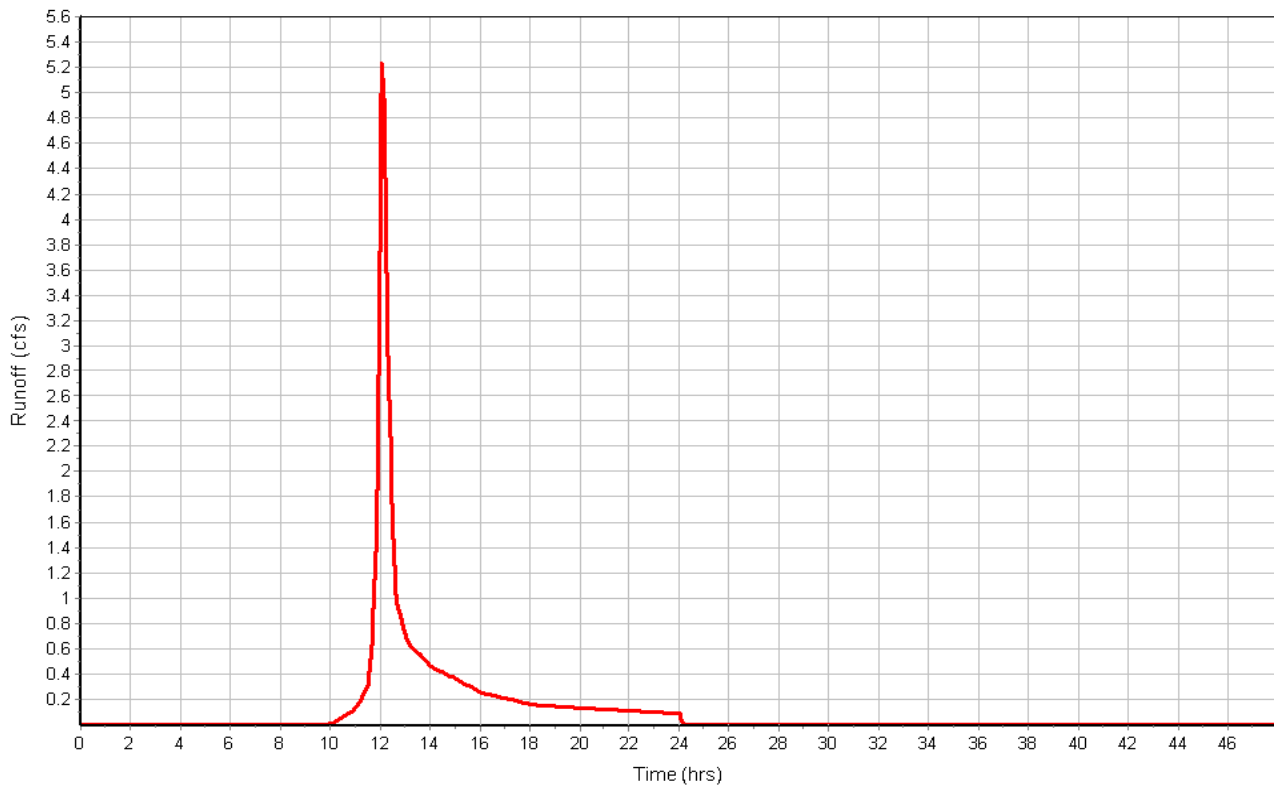

**Subbasin : B-2**

**Input Data**

Area (ac) ..... 7.03  
 Weighted Curve Number ..... 70.54  
 Rain Gage ID ..... Rain Gage-01

**Composite Curve Number**

Soil/Surface Description	Area (acres)	Soil Group	Curve Number
Brush, Good	5.19	D	73.00
Gravel roads	0.05	D	91.00
> 75% grass cover, Good	0.16	D	80.00
Gravel_Pad	1.58	D	60.00
ConcreteFoundations	0.05	D	98.00
Composite Area & Weighted CN	7.03		70.54

**Time of Concentration**

	Subarea A	Subarea B	Subarea C
Sheet Flow Computations			
Manning's Roughness :	.4	0.00	0.00
Flow Length (ft) :	100	0.00	0.00
Slope (%) :	.25	0.00	0.00
2 yr, 24 hr Rainfall (in) :	3.00	0.00	0.00
Velocity (ft/sec) :	0.03	0.00	0.00
Computed Flow Time (min) :	50.95	0.00	0.00
Shallow Concentrated Flow Computations			
Flow Length (ft) :	791	0.00	0.00
Slope (%) :	.5	0.00	0.00
Surface Type :	Grass pasture	Unpaved	Unpaved
Velocity (ft/sec) :	0.49	0.00	0.00
Computed Flow Time (min) :	26.90	0.00	0.00
Total TOC (min) .....	77.86		

**Subbasin Runoff Results**

Total Rainfall (in) ..... 5.50  
 Total Runoff (in) ..... 2.46  
 Peak Runoff (cfs) ..... 6.91  
 Weighted Curve Number ..... 70.54  
 Time of Concentration (days hh:mm:ss) ..... 0 01:17:52

**Subbasin : B-2**

**Rainfall Intensity Graph**

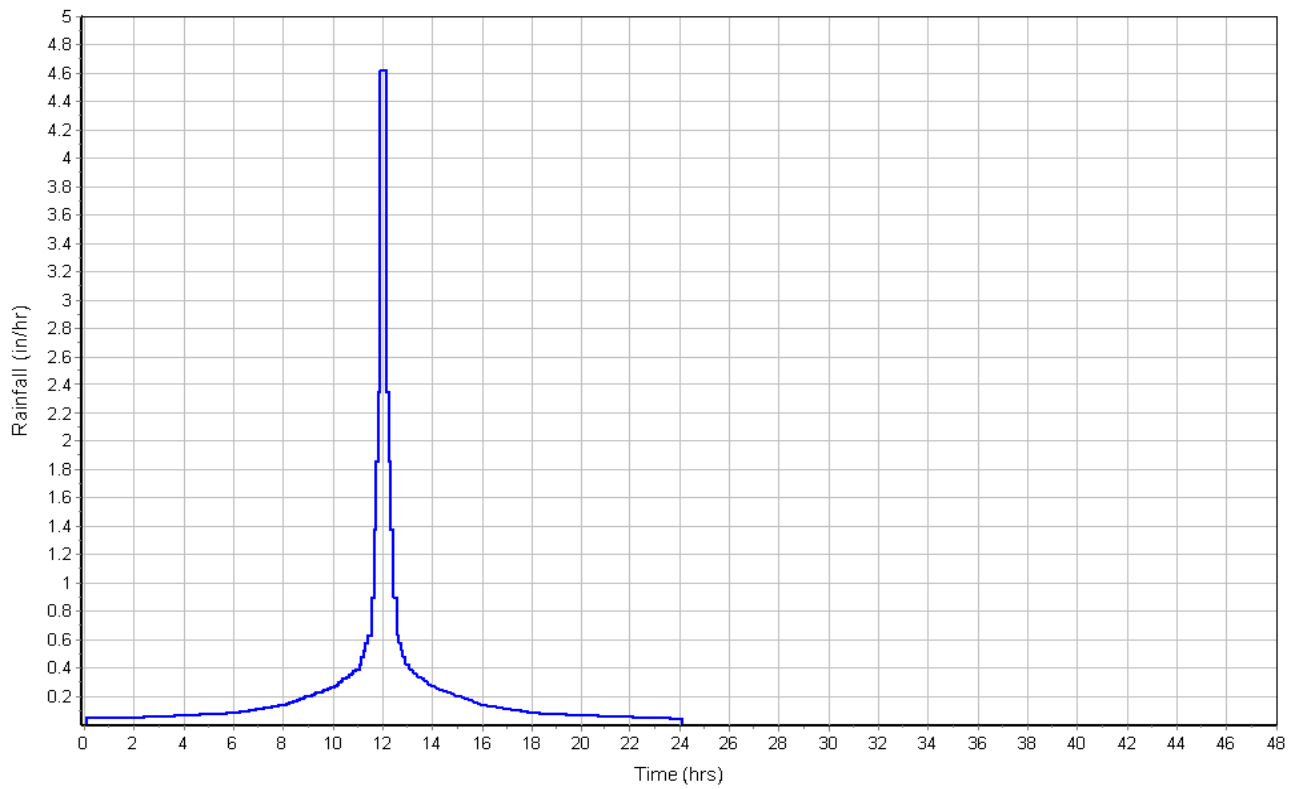

**Runoff Hydrograph**

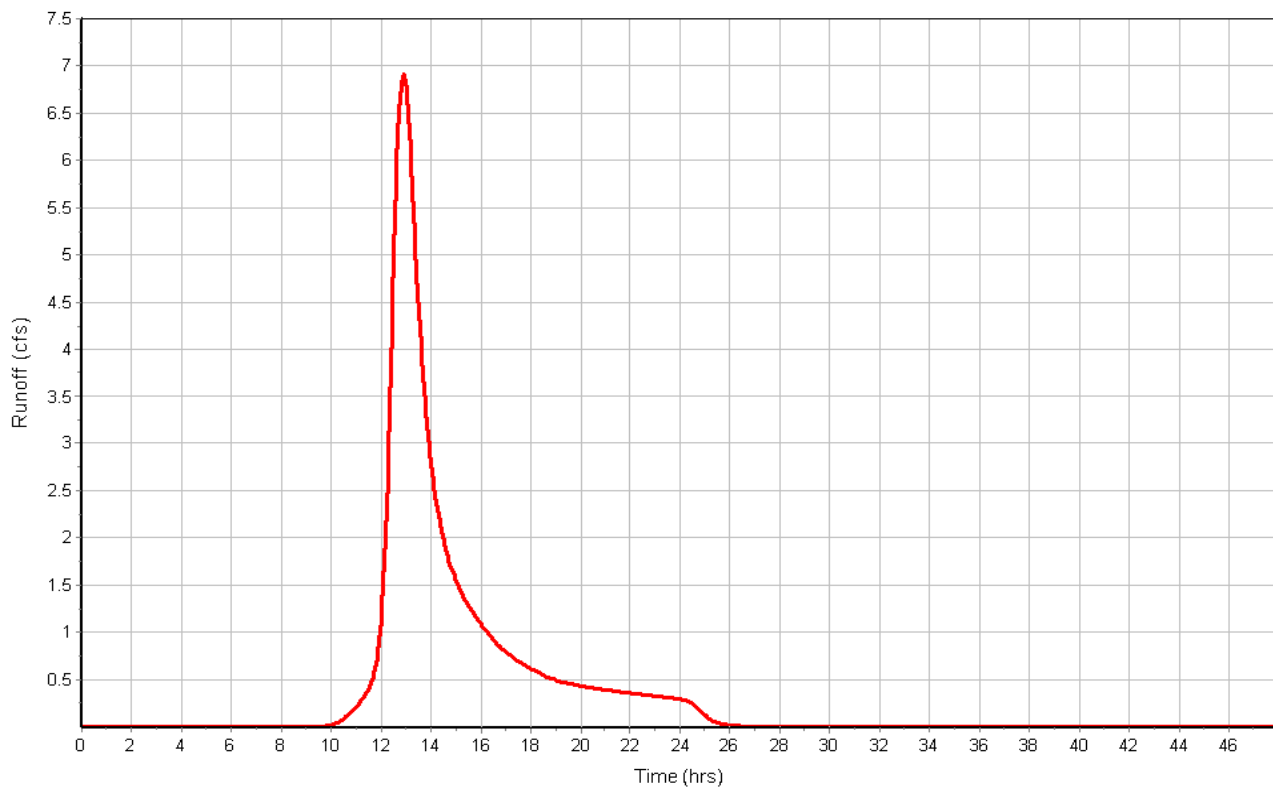

**Subbasin : C**

**Input Data**

Area (ac) ..... 0.21  
 Weighted Curve Number ..... 75.29  
 Rain Gage ID ..... Rain Gage-01

**Composite Curve Number**

Soil/Surface Description	Area (acres)	Soil Group	Curve Number
Woods, Good	0.12	D	77.00
Brush, Good	0.09	D	73.00
Composite Area & Weighted CN	0.21		75.29

**Time of Concentration**

	Subarea		
	A	B	C
Sheet Flow Computations			
Manning's Roughness :	.6	0.00	0.00
Flow Length (ft) :	80	0.00	0.00
Slope (%) :	4.31	0.00	0.00
2 yr, 24 hr Rainfall (in) :	3.00	0.00	0.00
Velocity (ft/sec) :	0.07	0.00	0.00
Computed Flow Time (min) :	18.88	0.00	0.00
Shallow Concentrated Flow Computations			
Flow Length (ft) :	182	0.00	0.00
Slope (%) :	7.1	0.00	0.00
Surface Type :	Grass pasture	Unpaved	Unpaved
Velocity (ft/sec) :	1.87	0.00	0.00
Computed Flow Time (min) :	1.62	0.00	0.00
Total TOC (min) .....	20.50		

**Subbasin Runoff Results**

Total Rainfall (in) ..... 5.50  
 Total Runoff (in) ..... 2.89  
 Peak Runoff (cfs) ..... 0.48  
 Weighted Curve Number ..... 75.29  
 Time of Concentration (days hh:mm:ss) ..... 0 00:20:30

Subbasin : C

Rainfall Intensity Graph

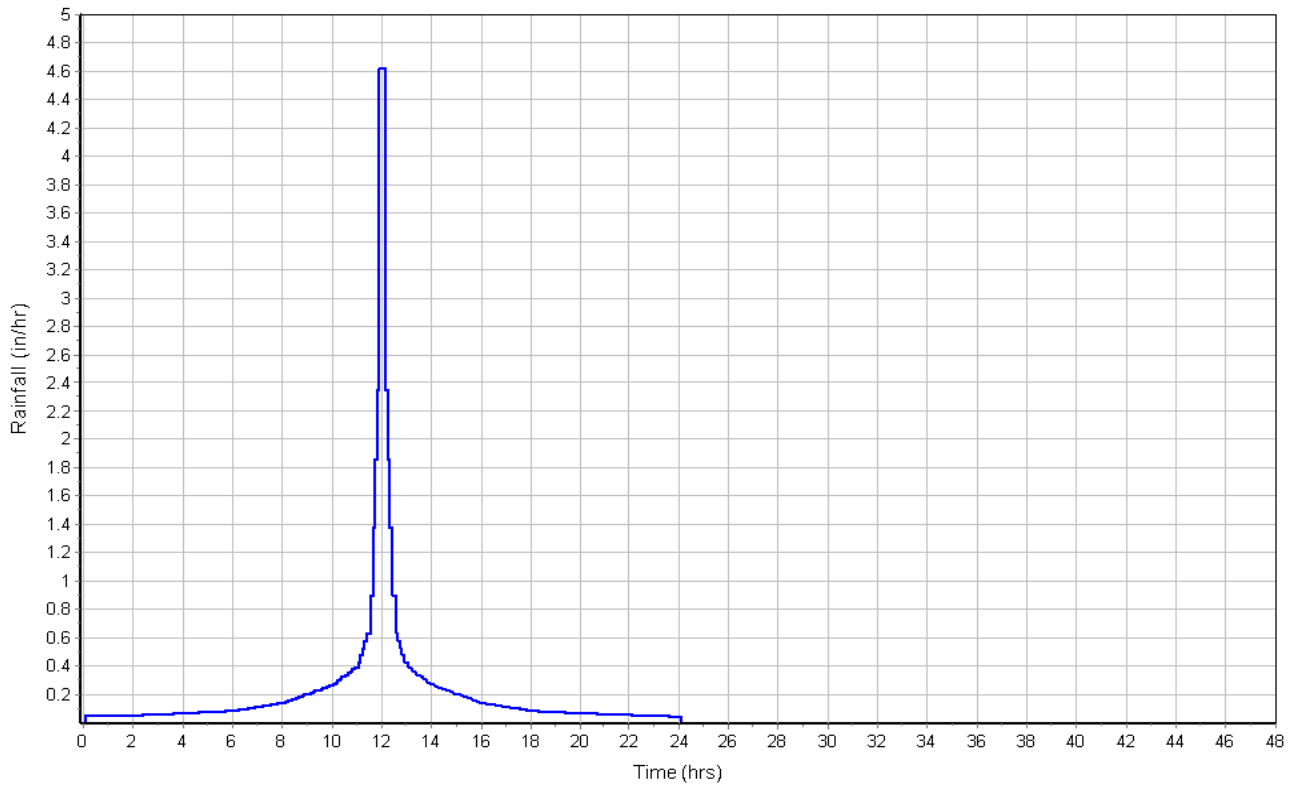

Runoff Hydrograph

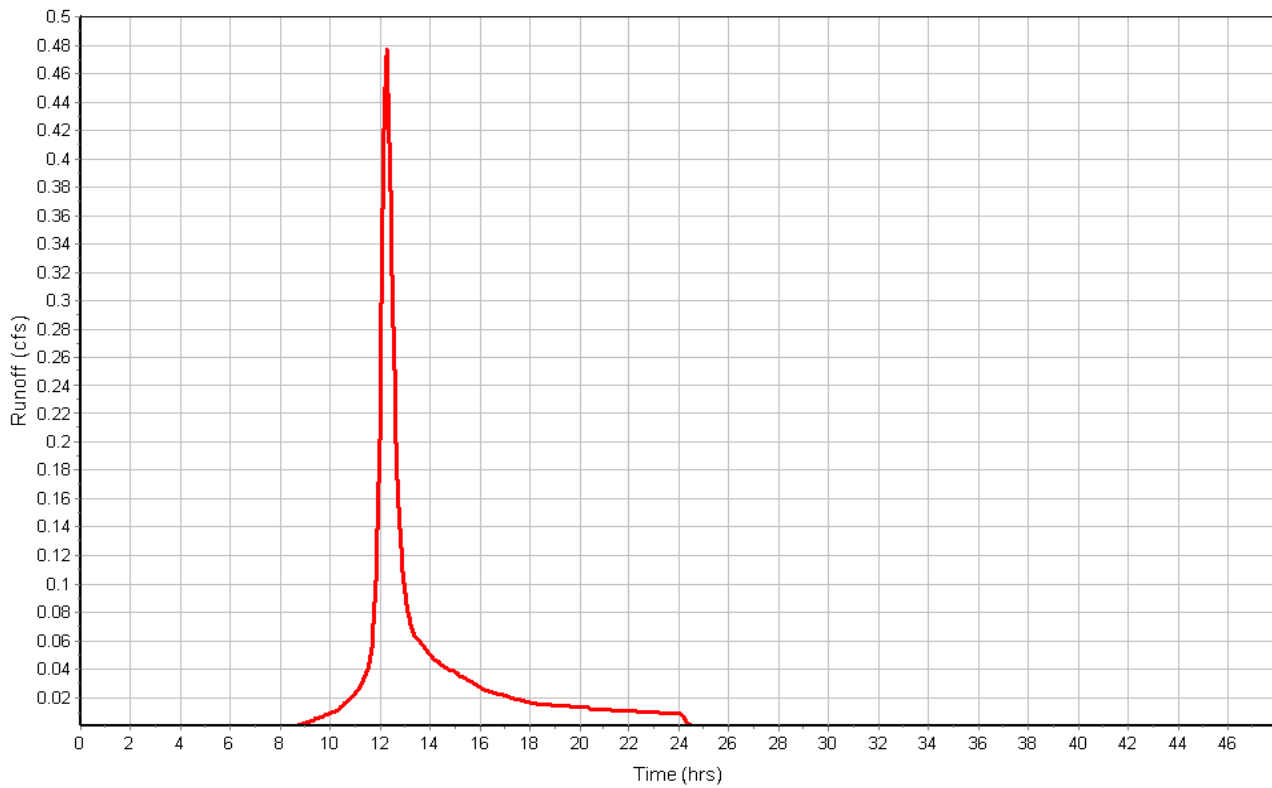



**Subbasin : CulvertDrainageArea**

**Input Data**

Area (ac) ..... 0.68  
Weighted Curve Number ..... 75.00  
Rain Gage ID ..... Rain Gage-01

**Composite Curve Number**

Soil/Surface Description	Area (acres)	Soil Group	Curve Number
-	0.68	-	75.00
Composite Area & Weighted CN	0.68		75.00

**Time of Concentration**

User-Defined TOC override (minutes): 5

**Subbasin Runoff Results**

Total Rainfall (in) ..... 5.50  
Total Runoff (in) ..... 2.86  
Peak Runoff (cfs) ..... 2.03  
Weighted Curve Number ..... 75.00  
Time of Concentration (days hh:mm:ss) ..... 0 00:05:00

Subbasin : CulvertDrainageArea

Rainfall Intensity Graph

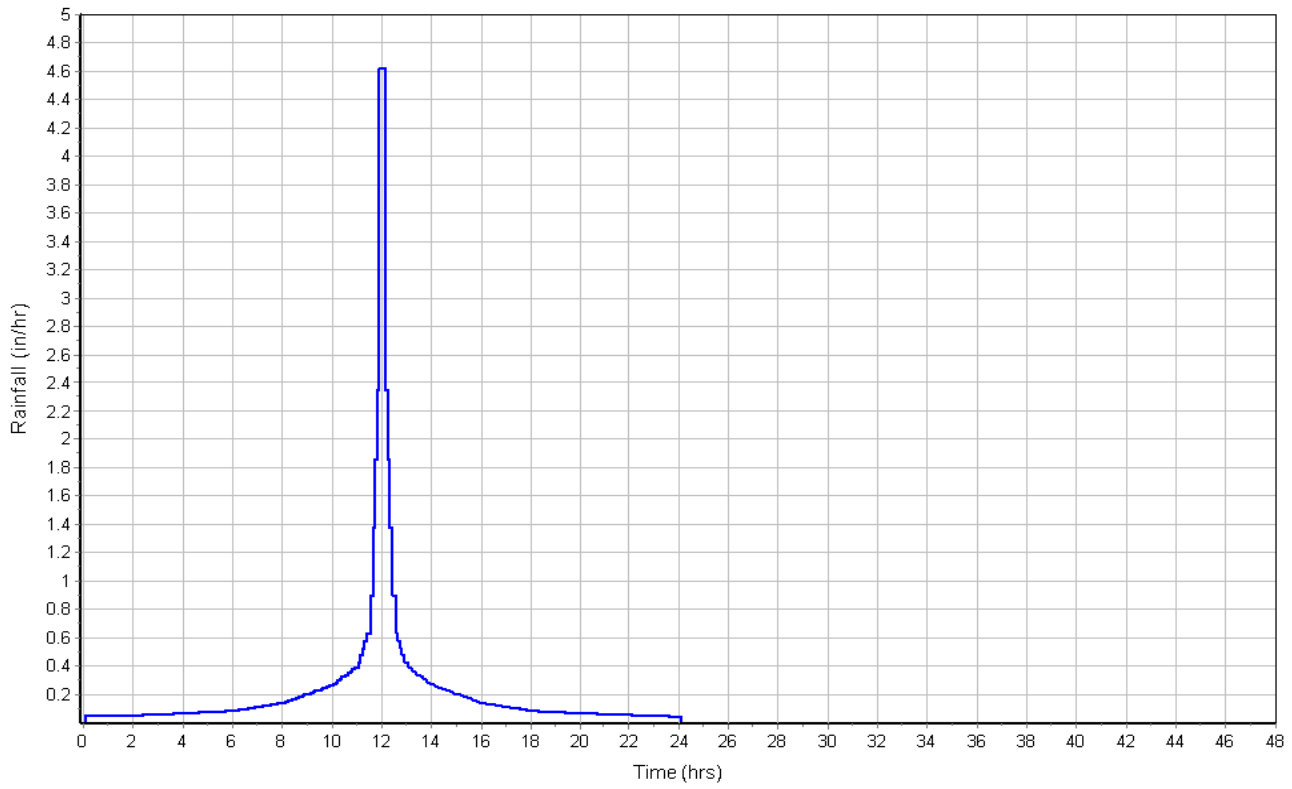

Runoff Hydrograph

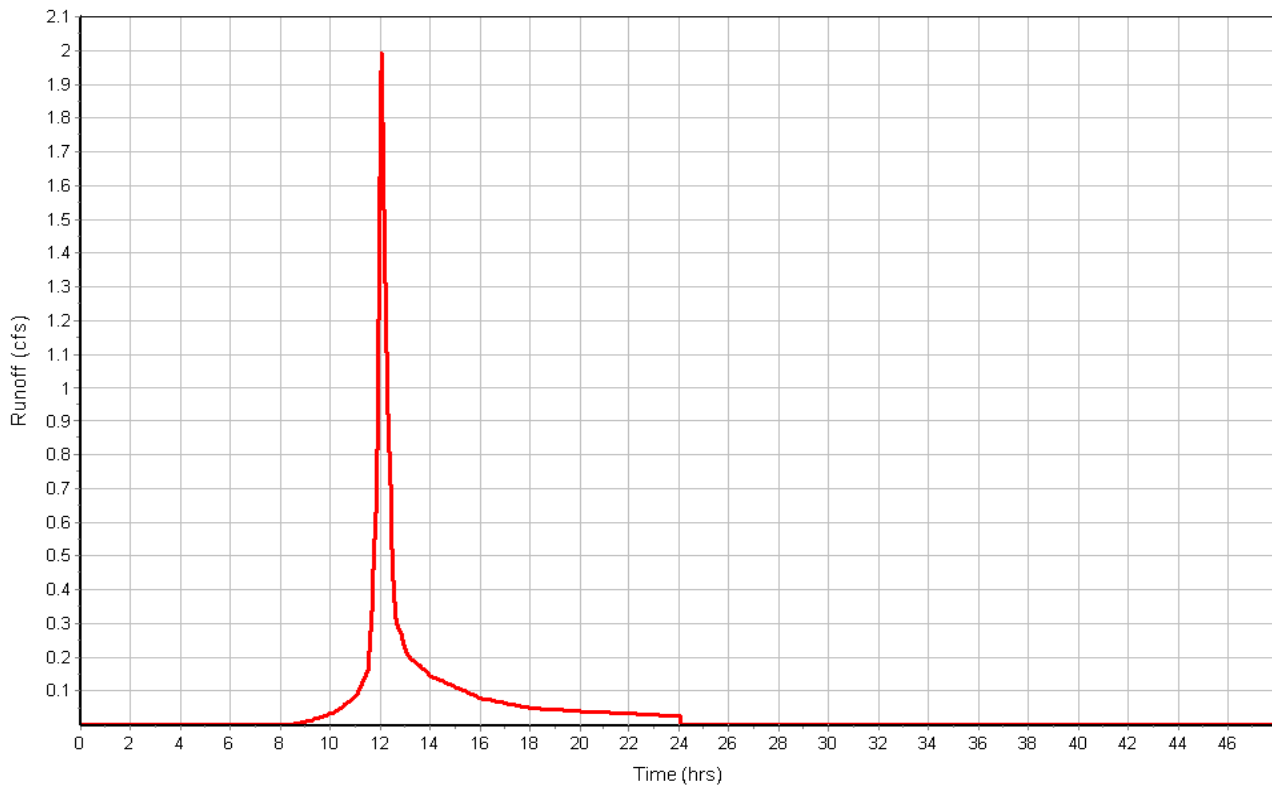

**Subbasin : D**

**Input Data**

Area (ac) ..... 0.12  
 Weighted Curve Number ..... 77.00  
 Rain Gage ID ..... Rain Gage-01

**Composite Curve Number**

Soil/Surface Description	Area (acres)	Soil Group	Curve Number
Woods, Good	0.12	D	77.00
Composite Area & Weighted CN	0.12		77.00

**Time of Concentration**

Sheet Flow Computations	Subarea	Subarea	Subarea
	A	B	C
Manning's Roughness :	.4	0.00	0.00
Flow Length (ft) :	36	0.00	0.00
Slope (%) :	5.55	0.00	0.00
2 yr, 24 hr Rainfall (in) :	3.00	0.00	0.00
Velocity (ft/sec) :	0.09	0.00	0.00
Computed Flow Time (min) :	6.51	0.00	0.00
Total TOC (min) .....	6.51		

**Subbasin Runoff Results**

Total Rainfall (in) ..... 5.50  
 Total Runoff (in) ..... 3.04  
 Peak Runoff (cfs) ..... 0.38  
 Weighted Curve Number ..... 77.00  
 Time of Concentration (days hh:mm:ss) ..... 0 00:06:31

Subbasin : D

Rainfall Intensity Graph

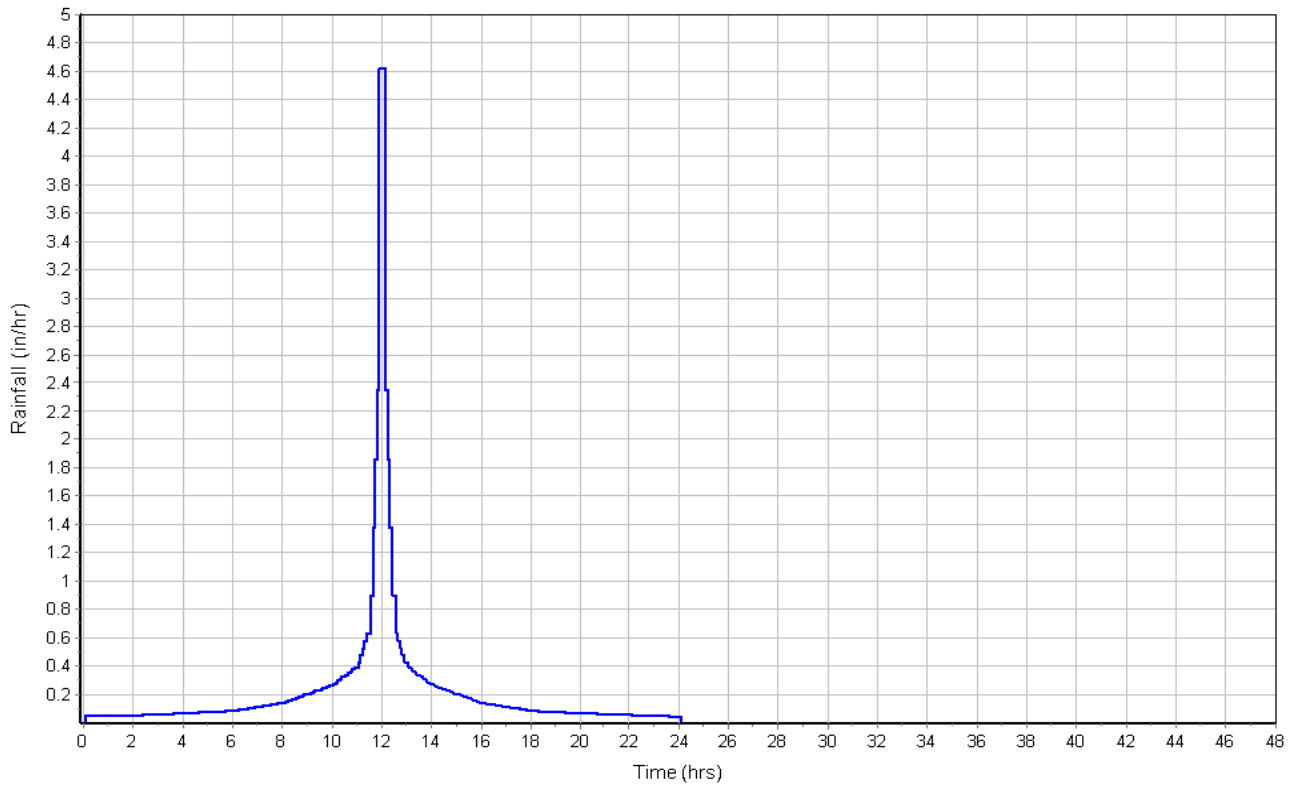

Runoff Hydrograph

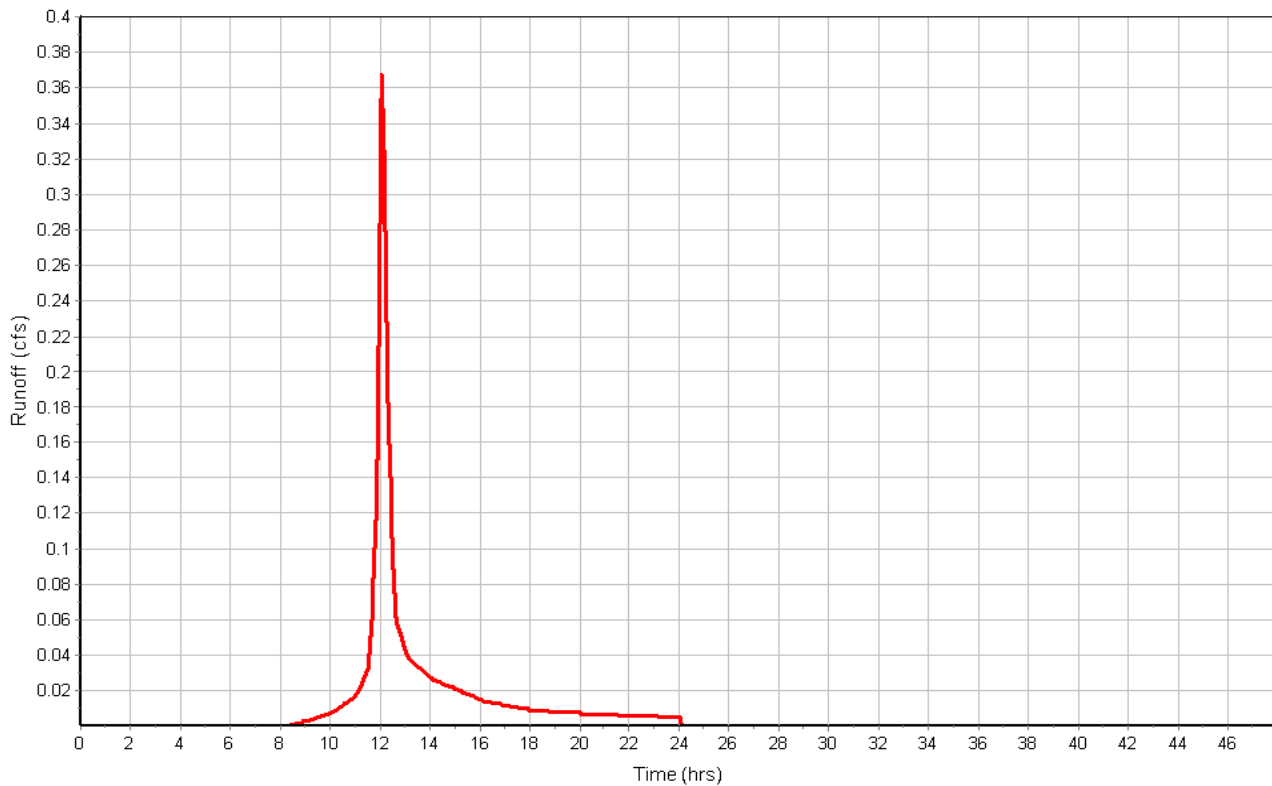

## Junction Input

Element ID	Invert Elevation (ft)	Ground/Rim (Max) Elevation (ft)
CulvertInlet	181.00	184.00
Out_B1andB2	176.00	6.00

## Junction Results

Element ID	Peak Inflow	Max HGL Elevation	Max HGL Depth	Min Freeboard	Average HGL Elevation	Time of Max HGL Occurrence
	(cfs)	(ft)	(ft)	(ft)	(ft)	(days hh:mm)
CulvertInlet	1.99	181.52	0.52	2.48	181.04	0 12:10
Out_B1andB2	7.71	176.00	0.00	0.00	176.00	0 00:00

## Pipe Input

Element ID	Length (ft)	Inlet Invert Elevation (ft)	Outlet Invert Elevation (ft)	Average Pipe Slope (%)	Pipe Shape	Pipe Diameter or Height (in)	Pipe Width (in)	Manning's Roughness
Direct_to_OutB	1715.96	0.00	0.00	0.0000	Dummy	0.000	0.000	0.0150
Link-03	45.00	181.00	180.55	1.0000	CIRCULAR	15.000	15.000	0.0150

## Pipe Results

Element ID	Peak Flow	Time of Peak Flow Occurrence	Design Flow Capacity	Peak Flow Velocity	Peak Flow Depth
	(cfs)	(days hh:mm)	(cfs)	(ft/sec)	(ft)
Direct_to_OutB	7.71	0 12:55	0.00	0.00	0.00
Link-03	1.98	0 12:10	5.60	4.17	0.51



**FILTER NOTES:**

1. UNDERDRAIN PIPES SHALL BE SCH. 40 PVC. ENDS OF UNDERDRAIN PIPING SHALL BE PLUGGED WITH PIPE FITTINGS. PIPE JOINTS SHALL BE FULLY GLUED.
2. SOIL FILTER OUTLET PIPE SHALL HAVE 6" DIA. BALL VALVE, WITH 22 - 43 GPM FLOW RATE CAPACITY.
3. COMPACT EMBANKMENT MATERIAL TO 93% OF MAXIMUM DENSITY AS DETERMINED BY ASTM D1557.
4. FILTER BED & SIDE SLOPES SHALL BE SEEDED USING "NEW ENGLAND CONSERVATION/WILDLIFE MIX" FROM NEW ENGLAND WETLAND PLANTS, INC. OF AMHERST, MA. OR APPROVED EQUAL (APPLICATION RATE 25#/ACRE).
5. MDT 703.22 UNDERDRAIN BACKFILL MATERIAL, TYPE B SPECIFICATIONS.

SIEVE	BY WEIGHT
1	90 - 100
1/2	75 - 100
#4	50 - 100
#20	15 - 80
#50	0 - 15
#200	0 - 5

**6. FILTER MEDIA MATERIALS:**

- 6.1. FILTER TOPSOIL LAYER: A 6-INCH LAYER OF LOAMY TOPSOIL SUCH AS USDA SANDY LOAM TOPSOIL WITH 5-8% HUMIFIED ORGANIC MATTER. SCREENED TOPSOIL FROM THE SITE MAY BE APPROPRIATE BUT SHALL BE TESTED FOR ORGANIC CONTENT. ORGANIC MATTER (SUCH AS SUPERHUMUS OR EQUIVALENT) MAY BE ADDED IF NECESSARY, PROVIDED THAT THE RESULTING TEXTURE IS SUITABLE. SEE EROSION CONTROL DETAILS FOR EROSION CONTROL BLANKET INSTALLATION REQUIREMENTS.
- 6.2. FILTER SAND LAYER: A 12-INCH LAYER OF LOAMY COARSE SAND PER MAINE DEP STORMWATER BEST MANAGEMENT PRACTICES TABLE 7.1.3.

SIEVE	BY WEIGHT
#10	85-100
#20	70-100
#60	15-40
#200	8-15
#200 (CLAY SIZE)	<2.0

**FILTER CONSTRUCTION INSPECTION AND TESTING NOTES:**

1. INSPECTION OF THE FILTER BASIN SHALL BE PROVIDED FOR EACH PHASE OF CONSTRUCTION BY THE DESIGN ENGINEER WITH REQUIRED REPORTING TO THE MAINE DEP.
2. AT A MINIMUM INSPECTIONS WILL OCCUR:
  - 2.1. AFTER PRELIMINARY CONSTRUCTION OF THE FILTER GRADES AND ONCE THE UNDERDRAIN PIPES ARE INSTALLED BUT NOT BACKFILLED;
  - 2.2. AFTER THE DRAINAGE LAYER IS CONSTRUCTED AND PRIOR TO THE INSTALLATION OF THE FILTER SAND LAYER;
  - 2.3. AFTER FILTER SAND LAYER IS CONSTRUCTED AND PRIOR TO THE INSTALLATION OF THE FILTER TOPSOIL LAYER;
  - 2.4. AFTER THE FILTER TOPSOIL LAYER HAS BEEN INSTALLED AND SEEDED; AND
  - 2.5. AFTER ONE YEAR TO INSPECT HEALTH OF THE VEGETATION AND MAKE CORRECTIONS.
3. THE CONTRACTOR SHALL PROVIDE SUBMITTALS FOR EACH COMPONENT OF THE FILTER MEDIA, IDENTIFYING THE SOURCE.
4. ALL MATERIAL USED FOR THE CONSTRUCTION OF THE FILTER BASIN WILL BE APPROVED BY THE DESIGN ENGINEER, AFTER TESTS BY A CERTIFIED LABORATORY SHOW THAT THEY ARE PASSING MAINE DEP SPECIFICATIONS.
5. THE CONTRACTOR SHALL SUBMIT SAMPLES OF EACH TYPE OF MATERIAL TO BE USED FOR THE MIXED FILTER MEDIA AND SAMPLES OF THE UNDERDRAIN BEDDING MATERIAL. SAMPLES MUST BE A COMPOSITE OF THREE DIFFERENT LOCATIONS (GRABS) FROM THE STOCKPILE OR PIT FACE. SAMPLE SIZE REQUIRED WILL BE DETERMINED BY THE TESTING LABORATORY.
6. THE CONTRACTOR SHALL PERFORM, OR HAVE PERFORMED, A SIEVE ANALYSIS CONFORMING TO ASTM C138 ON EACH TYPE OF THE SAMPLE MATERIAL. ALL MATERIALS SHALL HAVE A CLAY CONTENT OF LESS THAN 2% AS DETERMINED BY HYDROMETER GRAIN SIZE ANALYSIS.
7. THE CONTRACTOR SHALL PERFORM, OR HAVE PERFORMED, A PERMEABILITY TEST ON THE SOIL FILTER MEDIA MATERIALS CONFORMING TO ASTM D2434 WITH THE MIXTURE COMPACTED TO 90 - 92% OF MAXIMUM DRY DENSITY BASED ON ASTM D698.

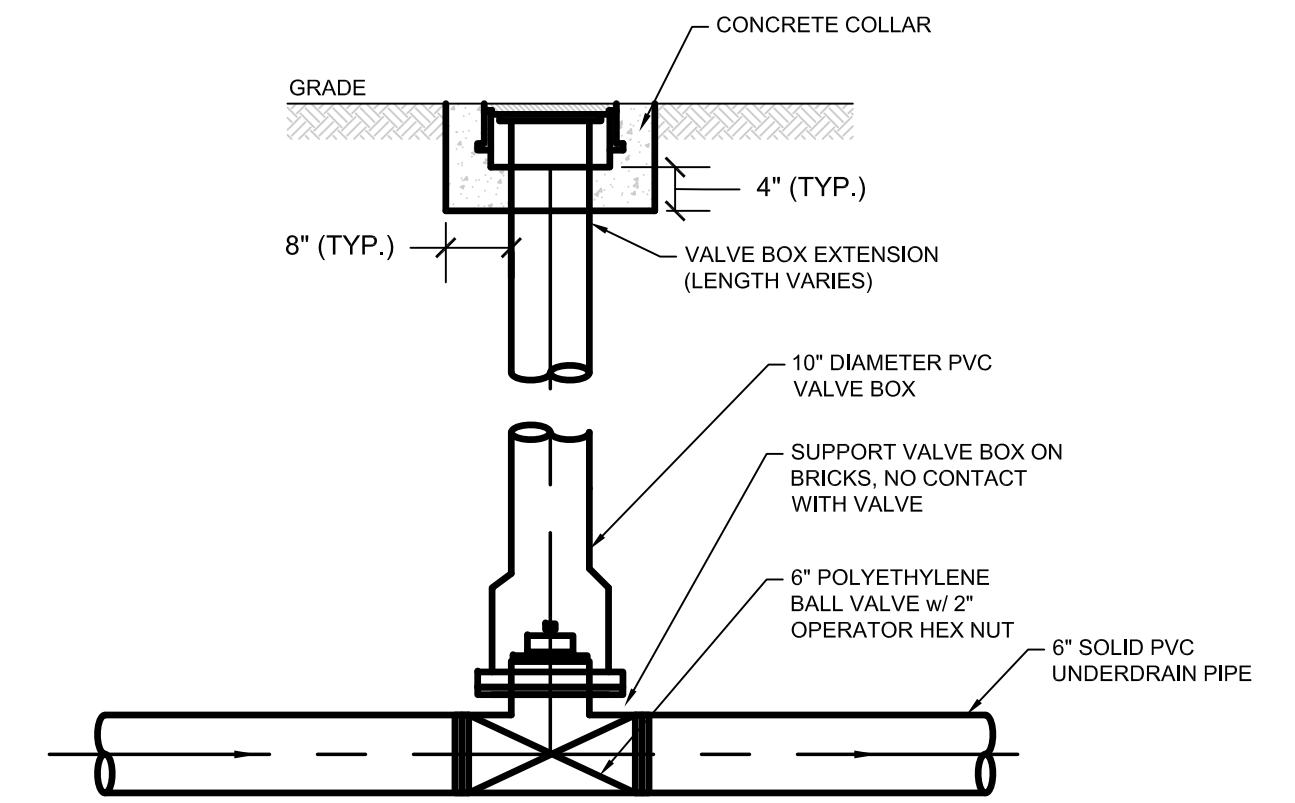
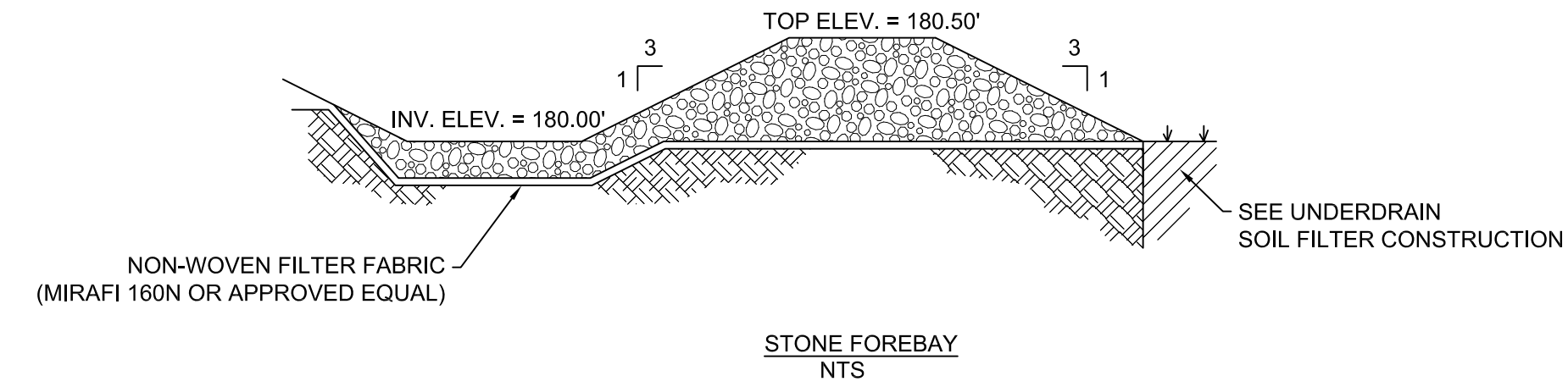

**NOTES:**

1. INSTALL THE BALL VALVE DURING THE INITIAL PIPE INSTALLATION IN THE FULLY-OPEN POSITION
2. FOLLOWING INITIAL RAIN EVENT THAT PRODUCE OBSERVED OUTFLOW, CLOSE VALVE TO ALLOW AN OUTFLOW OF BETWEEN 22-43 GPM FOR A DEWATERING TIME OF 24-48 HOURS
3. TURN VALVE 1/2 TO 3/4 CLOSED TO ACHIEVE THE REQUIRED MAXIMUM FLOW RATE

**6" SOIL FILTER UNDERDRAIN BALL VALVE NTS**

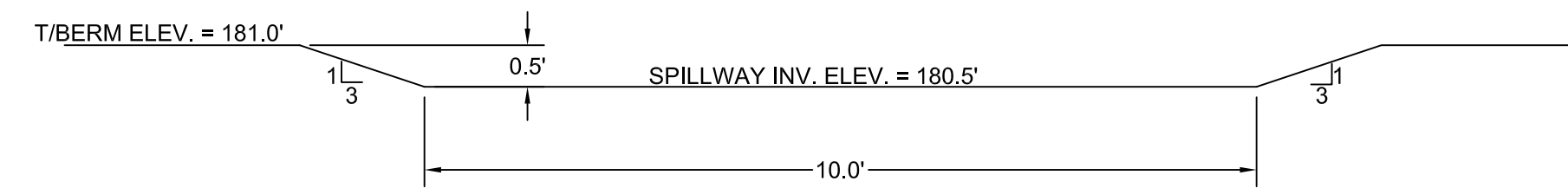

QPEAK, 25-YEAR = 5.55 CFS  
 VPEAK, 25-YEAR = 1.64 FPS  
 WEIR LENGTH = 10'  
 WEIR HEIGHT = 0.5'  
 FLOW DEPTH, 25-YEAR = 0.31'

**UNDERDRAINED SOIL FILTER EMERGENCY SPILLWAY NTS**

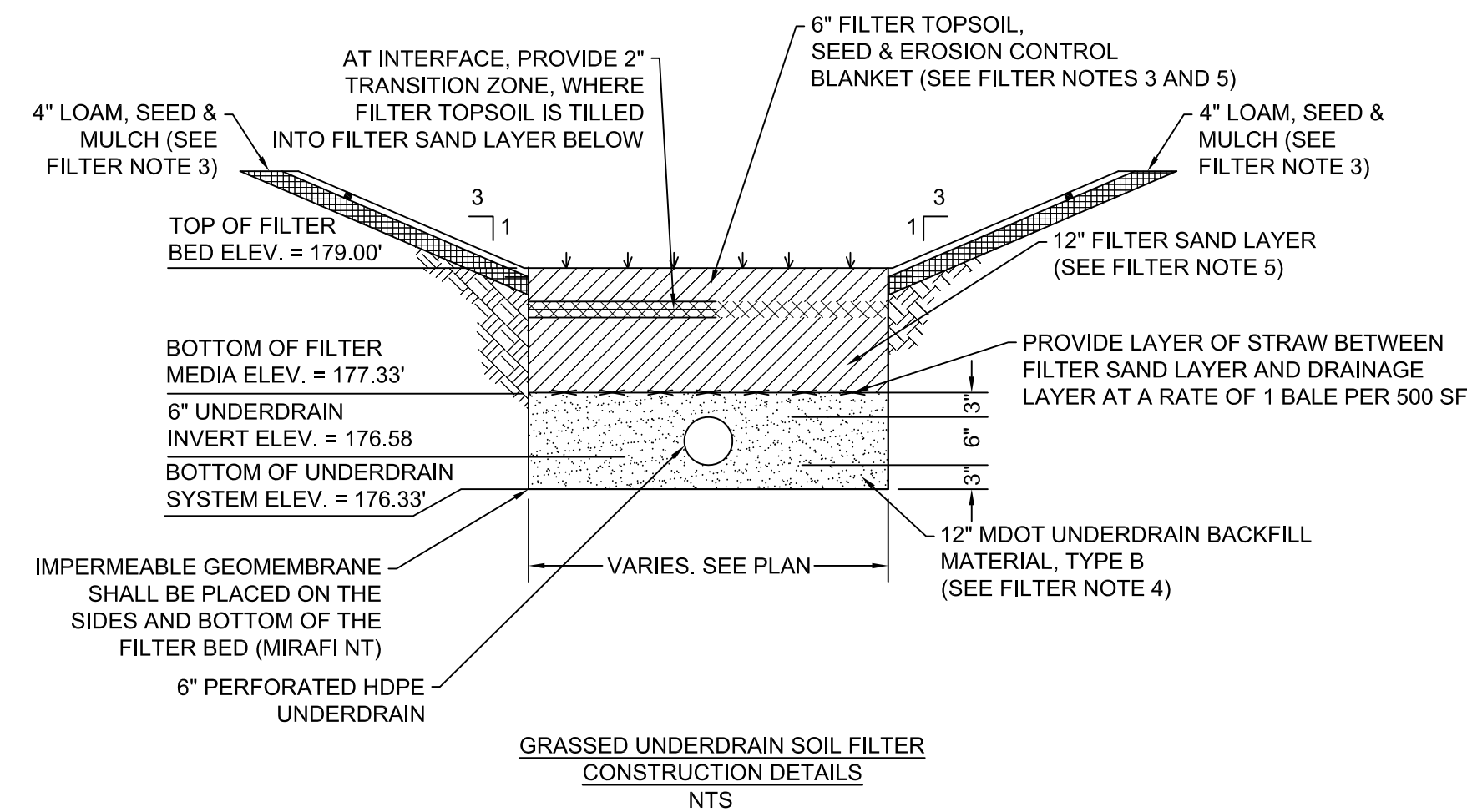

**GRASSED UNDERDRAIN SOIL FILTER CONSTRUCTION DETAILS NTS**

NOTE:  
 FILTER CROSS SECTION IS SHOWN FOR GRAPHICAL PURPOSES ONLY - NOT TRUE SCALE.

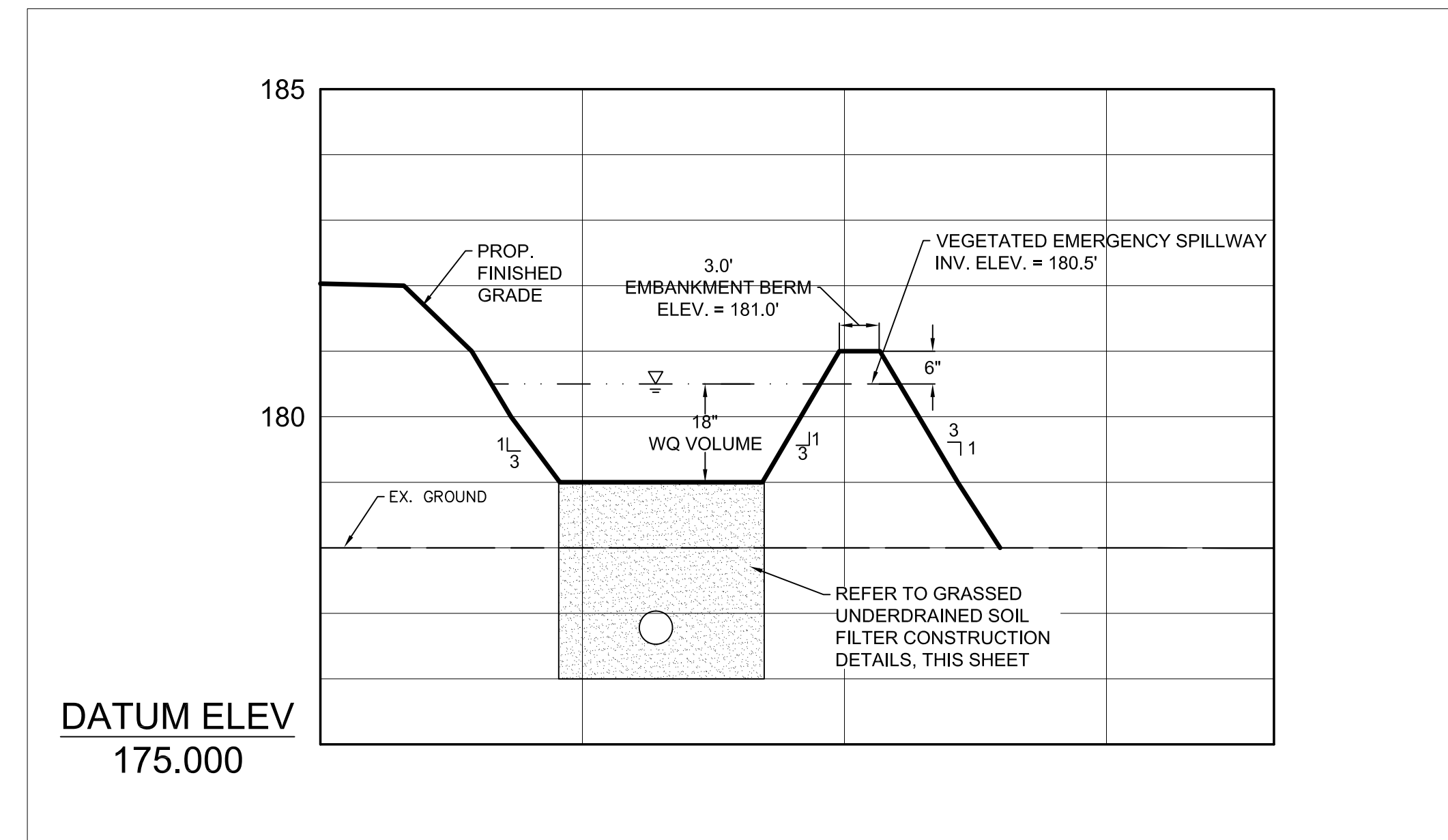

DATUM ELEV  
 175.000

**ISSUED FOR REVIEW**  
**NOT FOR CONSTRUCTION 05/29/18**

REV.	DESCRIPTION	DATE	BY	CK	APP
B	MEDEP PERMIT SET COMMENT REVISIONS	05/29/18	TJG	KRV	

OWNER ENGINEER:	APPROVAL STAMP:	PE Stamp
DRAWING PREPARED BY:	ACCEPTED BY OE:	

<b>USA ENGINEERING</b> CONFIDENTIAL, PROPRIETARY and TRADE SECRET INFORMATION Property of Iberdrola, USA					
REV.	DATE	BY	DESCRIPTION	APP.	DATE

<b>STORMWATER TREATMENT PLAN</b>	
SH 1 OF 3	
<b>FICKETT ROAD/1077 POWNAL, ME</b>	
DR: TJG	SCALE: N/A
CK: KRV	NO.
APP.	DATE
1077-003-003	

ANSI D CADD Drawing, DO NOT REVISE MANUALLY.



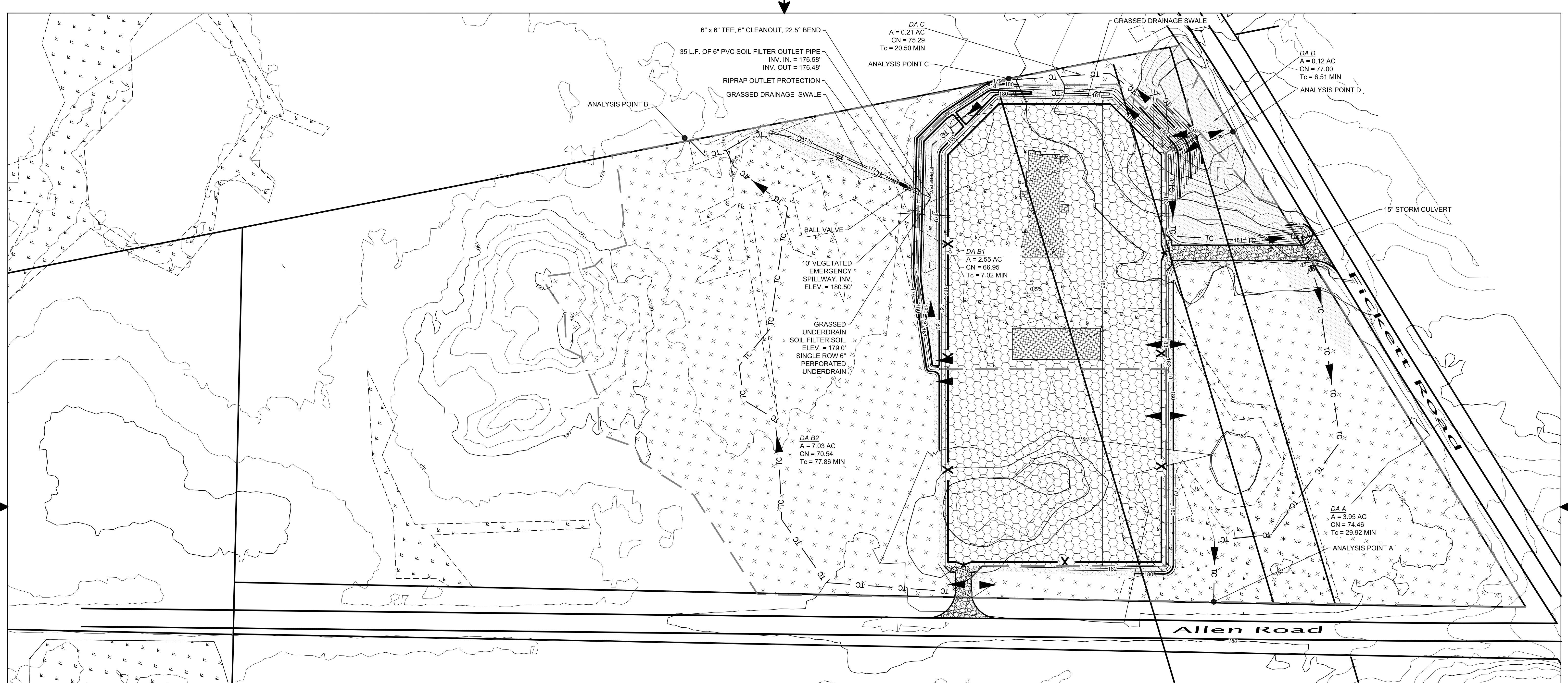

6" x 6" TEE, 6" CLEANOUT, 22.5" BEND  
 35 L.F. OF 6" PVC SOIL FILTER OUTLET PIPE  
 INV. IN. = 176.58'  
 INV. OUT. = 176.48'  
 RIPRAP OUTLET PROTECTION  
 GRASSED DRAINAGE SWALE

DA C  
 A = 0.21 AC  
 CN = 75.29  
 Tc = 20.50 MIN  
 ANALYSIS POINT C

DA D  
 A = 0.12 AC  
 CN = 77.00  
 Tc = 6.51 MIN  
 ANALYSIS POINT D

BALL VALVE  
 10' VEGETATED  
 EMERGENCY  
 SPILLWAY, INV.  
 ELEV. = 180.50'

GRASSED  
 UNDERDRAIN  
 SOIL FILTER SOIL  
 ELEV. = 179.0'  
 SINGLE ROW 6"  
 PERFORATED  
 UNDERDRAIN

DA B2  
 A = 7.03 AC  
 CN = 70.54  
 Tc = 77.86 MIN

DA B1  
 A = 2.55 AC  
 CN = 66.95  
 Tc = 7.02 MIN

DA A  
 A = 3.95 AC  
 CN = 74.46  
 Tc = 29.92 MIN  
 ANALYSIS POINT A

Allen Road

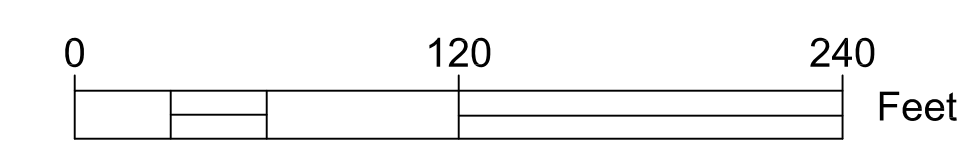
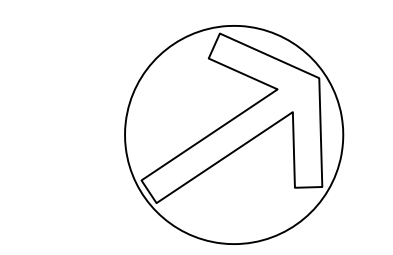

**LEGEND**

- 750 --- EX. MAJOR CONTOUR
- 744 --- EX. MINOR CONTOUR
- EX. SOIL BOUNDARY \*
- EX. OVERHEAD UTILITY
- EX. PROPERTY BOUNDARY
- EX. WETLAND
- \* SITE IS ENTIRELY HSG TYPE D SOILS
- 750 --- PROP. MAJOR CONTOUR
- 744 --- PROP. MINOR CONTOUR
- TC --- PROP. TIME OF CONCENTRATION
- ← PROP. FLOW DIRECTION ARROW
- PROP. DRAINAGE BOUNDARY
- ANALYSIS POINT
- PROP. CULVERT/PIPING

- EX. WOODS
- EX. BRUSH
- PROP. DEVELOPED GRASS/LANDSCAPE
- PROP. IMPERVIOUS SURFACE/ROOF
- PROP. STONE PAD
- PROP. GRAVEL ACCESS ROAD

PROPOSED CONDITIONS HYDRAULIC SUMMARY						
DRAINAGE AREA	2 - YEAR FLOW RATE (CFS)	10 - YEAR FLOW RATE (CFS)	25 - YEAR FLOW RATE (CFS)	PEAK 2 - YEAR FLOW RATE AT OUTFALL (IF SUBSHEDS PRESENT)	PEAK 10 - YEAR FLOW RATE AT OUTFALL (IF SUBSHEDS PRESENT)	PEAK 25 - YEAR FLOW RATE AT OUTFALL (IF SUBSHEDS PRESENT)
A	2.33	5.71	7.47	N/A	N/A	N/A
B1	1.30	4.05	5.55	2.06	5.73	7.71
B2	1.84	5.14	6.91	N/A	N/A	N/A
C	0.15	0.37	0.48	N/A	N/A	N/A
D	0.13	0.30	0.38	N/A	N/A	N/A

STORMWATER TREATMENT REQUIREMENTS (% OF TREATED AREA)		
LAND TYPE	STATION	STATION % TREATED
IMPERVIOUS TOTAL	3.90 AC	96.15%
IMPERVIOUS TREATED	3.75 AC	
DEVELOPED TOTAL*	4.87 AC	85.83%
DEVELOPED TREATED	4.18 AC	

\*DEVELOPED AREA INCLUDES BOTH IMPERVIOUS AND LANDSCAPED SURFACES

STORMWATER TREATMENT FOR PHOSPHOROUS STANDARD	
CONDITION	PHOSPHOROUS EXPORT LOAD (LBS P/YEAR)
PROJECT PHOSPHOROUS BUDGET	0.51
PRE-TREATMENT ALGAL AV. P EXPORT	1.65
POST-TREATMENT ALGAL AV. P EXPORT	0.45

**ISSUED FOR REVIEW**  
**NOT FOR CONSTRUCTION 05/29/18**

REV.	DESCRIPTION	DATE	BY	CK	APP
B	MEDEP PERMIT SET COMMENT REVISIONS	05/29/18	TJG	KRV	

OWNER ENGINEER: \_\_\_\_\_ APPROVAL STAMP: \_\_\_\_\_ PE Stamp: \_\_\_\_\_

DRAWING PREPARED BY: \_\_\_\_\_ ACCEPTED BY OE: \_\_\_\_\_

IUSA ENGINEERING				
CONFIDENTIAL, PROPRIETARY and TRADE SECRET INFORMATION				
Property of Iberdrola, USA				
REV.	DATE	BY	DESCRIPTION	APP.

**POST-DEVELOPMENT STORMWATER PLAN**

SH 3 OF 3

FICKETT ROAD/1077 POWNAL, ME

DR. TJG SCALE: 1" = 60' FILE: 1077-003-003SH003.DWG

CK. KRV NO. \_\_\_\_\_

APP. \_\_\_\_\_

1077-003-003 REV. B

CADD Drawings DO NOT REVISE MANUALLY.



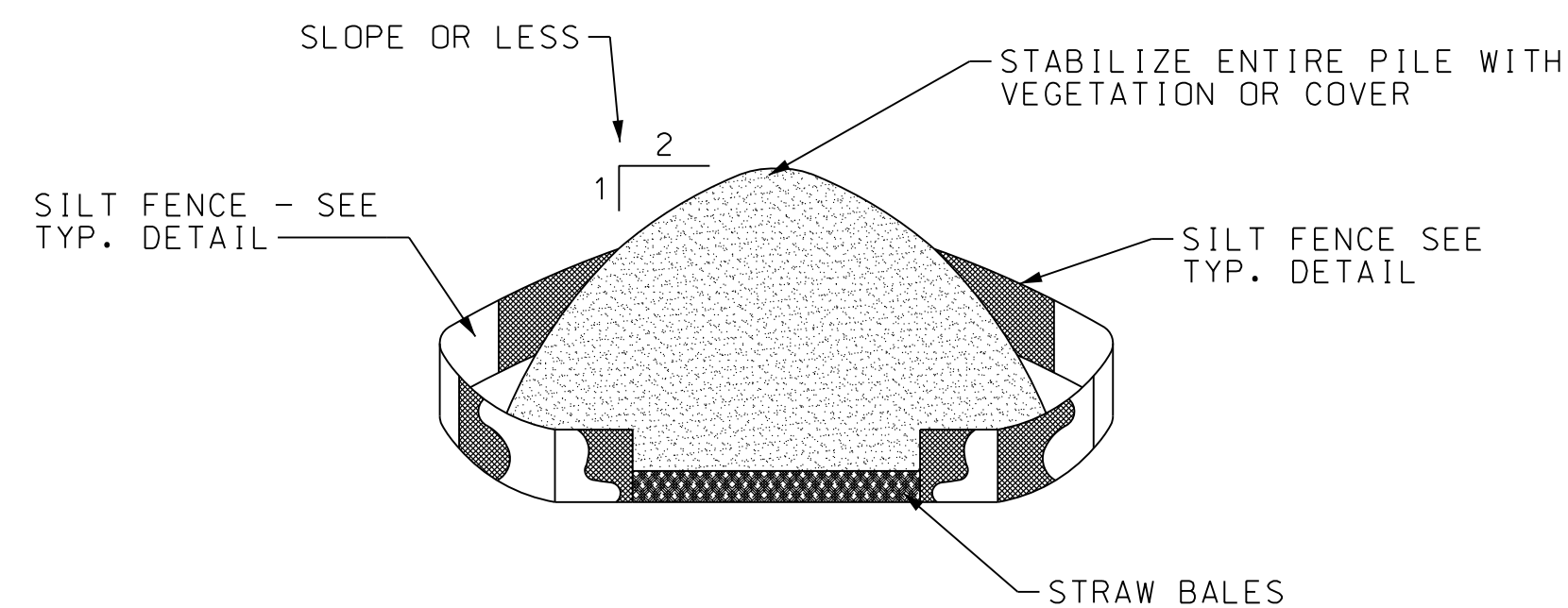
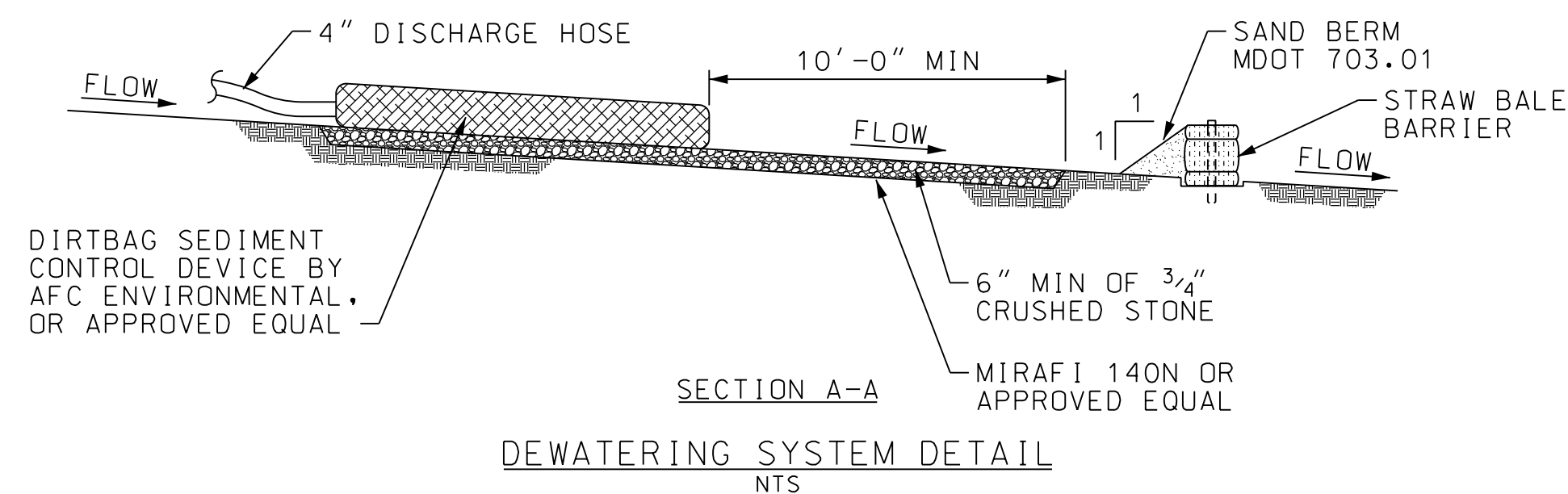
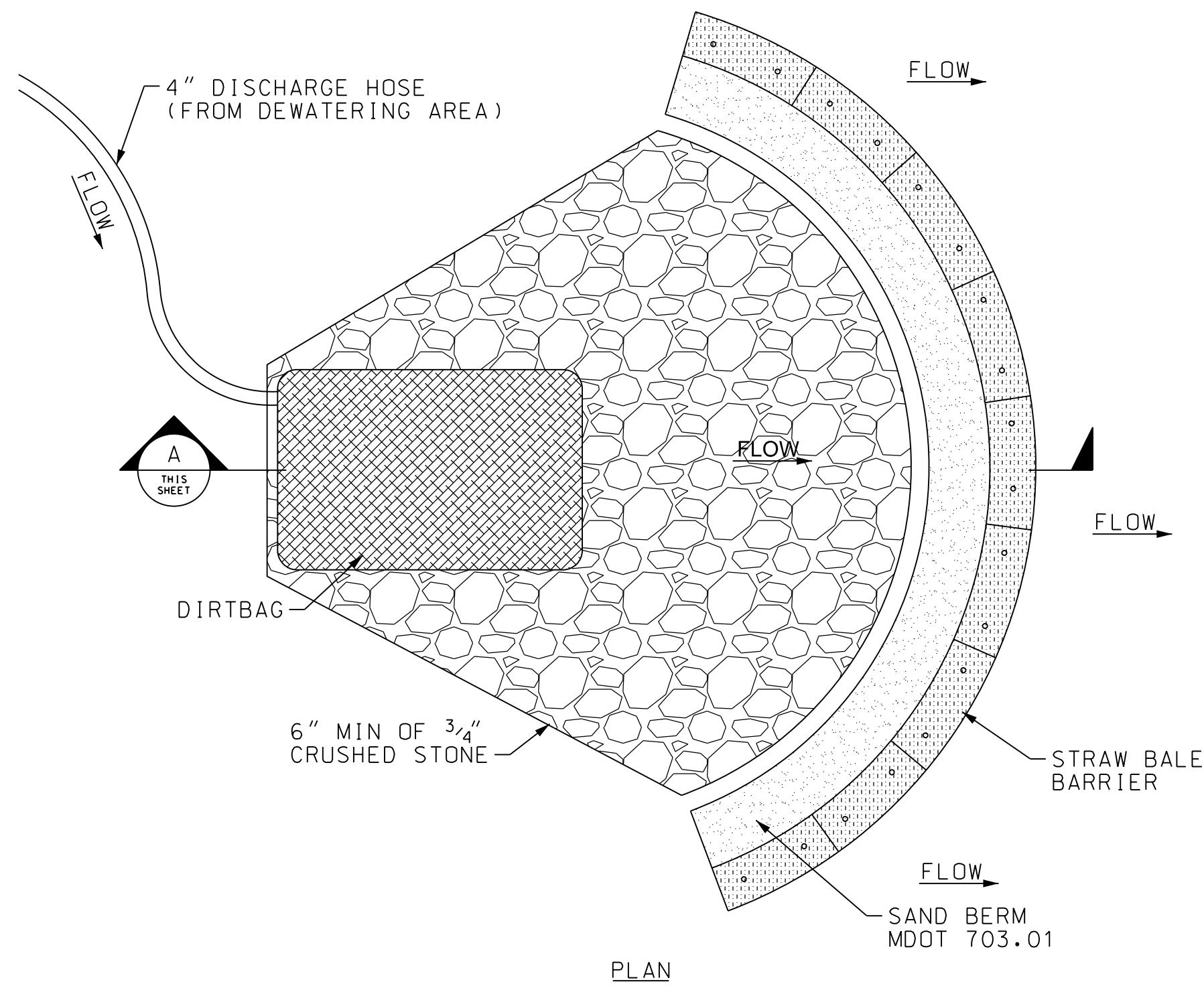

**DEWATERING NOTES:**

1. THE CONTRACTOR SHALL INSTALL, MAINTAIN, AND OPERATE ALL CHANNELS, SUMPS, AND ALL OTHER TEMPORARY DIVERSION AND PROTECTIVE WORKS NEEDED TO DIVERT STREAM FLOW AND OTHER SURFACE WATER THROUGH OR AROUND THE CONSTRUCTION SITE. CONTROL OF SURFACE WATER SHALL BE CONTINUOUS DURING THE PERIOD THAT DAMAGE TO CONSTRUCTION WORK COULD OCCUR.
2. OPEN EXCAVATIONS SHALL BE DEWATERED AND KEPT FREE OF STANDING WATER AND MUDDY CONDITIONS AS NECESSARY FOR THE PROPER EXECUTION OF THE WORK. THE CONTRACTOR SHALL FURNISH, INSTALL, OPERATE, AND MAINTAIN ALL DRAINS, SUMPS AND ALL OTHER EQUIPMENT REQUIRED TO PROPERLY DEWATER THE SITE. DEWATERING SYSTEMS THAT CAUSE A LOSS OF SOIL FINES FROM THE FOUNDATION AREAS WILL NOT BE PERMITTED.
3. INSTALL DIVERSION DITCHES OR BERMS IF NECESSARY TO MINIMIZE THE AMOUNT OF CLEAN STORMWATER RUNOFF ALLOWED INTO THE EXCAVATED AREA.
4. REMOVAL OF WATER FROM THE CONSTRUCTION SITE SHALL BE ACCOMPLISHED SO THAT EROSION AND THE TRANSPORTING OF SEDIMENT AND OTHER POLLUTANTS ARE MINIMIZED.
5. DISCHARGE DEWATERING EFFLUENT TO AREAS AS INDICATED ON THE SITE GRADING PLAN. DISCHARGE SHALL BE IN SHEET FLOW.
6. DEWATERING IN PERIODS OF INTENSE, HEAVY RAIN, WHEN THE INFILTRATIVE CAPACITY OF THE SOIL IS EXCEEDED, SHALL BE AVOIDED.
7. FLOW TO THE SEDIMENT REMOVAL STRUCTURE MAY NOT EXCEED THE STRUCTURE'S CAPACITY TO SETTLE AND FILTER FLOW OR THE STRUCTURE'S VOLUME CAPACITY.
8. WHEN TEMPORARY WORKS ARE NO LONGER NEEDED, THE CONTRACTOR SHALL REMOVE AND RETURN THE AREA TO A CONDITION SIMILAR TO THAT WHICH EXISTED BEFORE CONSTRUCTION. AREAS WHERE TEMPORARY WORKS WERE LOCATED SHALL BE GRADED FOR SLIGHTLY APPEARANCE WITH NO OBSTRUCTION TO NATURAL SURFACE WATER FLOWS OR THE PROPER FUNCTIONING AND ACCESS TO THE WORKS OF IMPROVEMENT INSTALLED. THE CONTRACTOR SHALL EXERCISE EXTREME CARE DURING THE REMOVAL STAGES TO MINIMIZE THE LOSS OF SOIL SEDIMENT AND DEBRIS THAT WAS TRAPPED DURING CONSTRUCTION.

**HOUSEKEEPING PLAN:**

(MAINE DEP CHAPTER 500, APPENDIX C)

1. SPILL PREVENTION. CONTROLS MUST BE USED TO PREVENT POLLUTANTS FROM CONSTRUCTION AND WASTE MATERIALS STORED ON SITE TO ENTER STORMWATER, WHICH INCLUDES STORAGE PRACTICES TO MINIMIZE EXPOSURE OF THE MATERIALS TO STORMWATER. THE SITE CONTRACTOR OR OPERATOR MUST DEVELOP, AND IMPLEMENT AS NECESSARY, APPROPRIATE SPILL PREVENTION, CONTAINMENT, AND RESPONSE PLANNING MEASURES. ANY SPILL OR RELEASE OF TOXIC OR HAZARDOUS SUBSTANCES MUST BE REPORTED TO THE MAINE DEPARTMENT OF ENVIRONMENTAL PROTECTION (MDEP). FOR OIL SPILLS, CALL 1-800-482-0777 WHICH IS AVAILABLE 24 HOURS A DAY. FOR SPILLS OF TOXIC OR HAZARDOUS MATERIAL, CALL 1-800-452-4664 WHICH IS AVAILABLE 24 HOURS A DAY. FOR MORE INFORMATION, VISIT THE MDEP'S WEBSITE AT: <http://www.maine.gov/dep/spills/emergspillresp/>
2. GROUNDWATER PROTECTION. DURING CONSTRUCTION, LIQUID PETROLEUM PRODUCTS AND OTHER HAZARDOUS MATERIALS WITH THE POTENTIAL TO CONTAMINATE GROUNDWATER MAY NOT BE STORED OR HANDLED IN AREAS OF THE SITE DRAINING TO AN INFILTRATION AREA. AN "INFILTRATION AREA" IS ANY AREA OF THE SITE THAT BY DESIGN OR AS A RESULT OF SOILS, TOPOGRAPHY AND OTHER RELEVANT FACTORS ACCUMULATES RUNOFF THAT INFILTRATES INTO THE SOIL. DIKES, BERMS, SUMPS, AND OTHER FORMS OF SECONDARY CONTAINMENT THAT PREVENT DISCHARGE TO GROUNDWATER MAY BE USED TO ISOLATE PORTIONS OF THE SITE FOR THE PURPOSES OF STORAGE AND HANDLING OF THESE MATERIALS. ANY PROJECT PROPOSING INFILTRATION OF STORMWATER MUST PROVIDE ADEQUATE PRE-TREATMENT OF STORMWATER PRIOR TO DISCHARGE OF STORMWATER TO THE INFILTRATION AREA, OR PROVIDE FOR TREATMENT WITHIN THE INFILTRATION AREA, IN ORDER TO PREVENT THE ACCUMULATION OF FINES, REDUCTION IN INFILTRATION RATE, AND CONSEQUENT FLOODING AND DESTABILIZATION.

LACK OF APPROPRIATE POLLUTANT REMOVAL BEST MANAGEMENT PRACTICES (BMPs) MAY RESULT IN VIOLATIONS OF THE GROUNDWATER QUALITY STANDARD ESTABLISHED BY 38 M.R.S.A. SECTION 465-C(1).

3. FUGITIVE SEDIMENT AND DUST. ACTIONS MUST BE TAKEN TO ENSURE THAT ACTIVITIES DO NOT RESULT IN NOTICEABLE EROSION OF SOILS OR FUGITIVE DUST EMISSIONS DURING OR AFTER CONSTRUCTION. OIL MAY NOT BE USED FOR DUST CONTROL, BUT OTHER WATER ADDITIVES MAY BE CONSIDERED AS NEEDED. A STABILIZED CONSTRUCTION ENTRANCE (SCE) SHOULD BE INCLUDED TO MINIMIZE TRACKING OF MUD AND SEDIMENT. IF OFF-SITE TRACKING OCCURS, PUBLIC ROADS SHOULD BE SWEEP IMMEDIATELY AND NO LESS THAN ONCE A WEEK AND PRIOR TO SIGNIFICANT STORM EVENTS. OPERATIONS DURING DRY MONTHS, THAT EXPERIENCE FUGITIVE DUST PROBLEMS, SHOULD WET DOWN UNPAVED ACCESS ROADS ONCE A WEEK OR MORE FREQUENTLY AS NEEDED WITH A WATER ADDITIVE TO SUPPRESS FUGITIVE SEDIMENT AND DUST.

DEWATERING A STREAM WITHOUT A PERMIT FROM THE MDEP MAY VIOLATE STATE WATER QUALITY STANDARDS AND THE NATURAL RESOURCES PROTECTION ACT.

**HOUSEKEEPING PLAN (CONT):**

4. DEBRIS AND OTHER MATERIALS. MINIMIZE THE EXPOSURE OF CONSTRUCTION DEBRIS, BUILDING AND LANDSCAPING MATERIALS, TRASH, FERTILIZERS, PESTICIDES, HERBICIDES, DETERGENTS, SANITARY WASTE AND OTHER MATERIALS TO PRECIPITATION AND STORMWATER RUNOFF. THESE MATERIALS MUST BE PREVENTED FROM BECOMING A POLLUTANT SOURCE.

TO PREVENT THESE MATERIALS FROM BECOMING A SOURCE OF POLLUTANTS, CONSTRUCTION AND POST-CONSTRUCTION ACTIVITIES RELATED TO A PROJECT MAY BE REQUIRED TO COMPLY WITH APPLICABLE PROVISIONS OF RULES RELATED TO SOLID, UNIVERSAL, AND HAZARDOUS WASTE, INCLUDING, BUT NOT LIMITED TO, THE MAINE SOLID WASTE AND HAZARDOUS WASTE MANAGEMENT RULES; MAINE HAZARDOUS WASTE MANAGEMENT RULES; MAINE OIL CONVEYANCE AND STORAGE RULES; AND MAINE PESTICIDE REQUIREMENTS.

5. EXCAVATION DE-WATERING. EXCAVATION DE-WATERING IS THE REMOVAL OF WATER FROM TRENCHES, FOUNDATIONS, COFFER DAMS, PONDS, AND OTHER AREAS WITHIN THE CONSTRUCTION AREA THAT RETAIN WATER AFTER EXCAVATION. IN MOST CASES THE COLLECTED WATER IS HEAVILY SILTED AND HINDERS CORRECT AND SAFE CONSTRUCTION PRACTICES. THE COLLECTED WATER REMOVED FROM THE PONDED AREA, EITHER THROUGH GRAVITY OR PUMPING, MUST BE SPREAD THROUGH NATURAL WOODED BUFFERS OR REMOVED TO AREAS THAT ARE SPECIFICALLY DESIGNED TO COLLECT THE MAXIMUM AMOUNT OF SEDIMENT POSSIBLE, LIKE A COFFERDAM SEDIMENTATION BASIN. AVOID ALLOWING THE WATER TO FLOW OVER DISTURBED AREAS OF THE SITE. EQUIVALENT MEASURES MAY BE TAKEN IF APPROVED BY THE MDEP.
6. AUTHORIZED NON-STORMWATER DISCHARGES. IDENTIFY AND PREVENT CONTAMINATION BY NON-STORMWATER DISCHARGES. WHERE ALLOWED NON-STORMWATER DISCHARGES EXIST, THEY MUST BE IDENTIFIED AND STEPS SHOULD BE TAKEN TO ENSURE THE IMPLEMENTATION OF APPROPRIATE POLLUTION PREVENTION MEASURES FOR THE NON-STORMWATER COMPONENT(S) OF THE DISCHARGE. AUTHORIZED NON-STORMWATER DISCHARGES ARE:

- (A) DISCHARGES FROM FIREFIGHTING ACTIVITY;
- (B) FIRE HYDRANT FLUSHINGS;
- (C) VEHICLE WASHWATER IF DETERGENTS ARE NOT USED AND WASHING IS LIMITED TO THE EXTERIOR OF VEHICLES (ENGINE, UNDERCARRIAGE AND TRANSMISSION WASHING IS PROHIBITED);
- (D) DUST CONTROL RUNOFF IN ACCORDANCE WITH PERMIT CONDITIONS AND PARAGRAPH 3 ABOVE;
- (E) ROUTINE EXTERNAL BUILDING WASHDOWN, NOT INCLUDING SURFACE PAINT REMOVAL, THAT DOES NOT INVOLVE DETERGENTS;
- (F) PAVEMENT WASHWATER (WHERE SPILLS/LEAKS OF TOXIC OR HAZARDOUS MATERIALS HAVE NOT OCCURRED, UNLESS ALL SPILLED MATERIAL HAD BEEN REMOVED) IF DETERGENTS ARE NOT USED;
- (G) UNCONTAMINATED AIR CONDITIONING OR COMPRESSOR CONDENSATE;
- (H) UNCONTAMINATED GROUNDWATER OR SPRING WATER;
- (I) FOUNDATION OR FOOTER DRAIN-WATER WHERE FLOWS ARE NOT CONTAMINATED;
- (J) UNCONTAMINATED EXCAVATION DEWATERING (SEE REQUIREMENTS IN PARAGRAPH 5 ABOVE);
- (K) POTABLE WATER SOURCES INCLUDING WATERLINE FLUSHINGS; AND LANDSCAPE IRRIGATION.

7. UNAUTHORIZED NON-STORMWATER DISCHARGES. THE MDEP'S APPROVAL UNDER THIS CHAPTER DOES NOT AUTHORIZE A DISCHARGE THAT IS MIXED WITH A SOURCE OF NONSTORMWATER, OTHER THAN THOSE DISCHARGES IN COMPLIANCE WITH PARAGRAPH 6 ABOVE. SPECIFICALLY, THE MDEP'S APPROVAL DOES NOT AUTHORIZE DISCHARGES OF THE FOLLOWING:

- (A) WASTEWATER FROM THE WASHOUT OR CLEANOUT OF CONCRETE, STUCCO, PAINT, FORM RELEASE OILS, CURING COMPOUNDS OR OTHER CONSTRUCTION MATERIALS;
- (B) FUELS, OILS OR OTHER POLLUTANTS USED IN VEHICLE AND EQUIPMENT OPERATION AND MAINTENANCE;
- (C) SOAPS, SOLVENTS, OR DETERGENTS USED IN VEHICLE AND EQUIPMENT WASHING; AND
- (D) TOXIC OR HAZARDOUS SUBSTANCES FROM A SPILL OR OTHER RELEASE.

**INSTALLATION NOTES:**

1. AREA CHOSEN FOR STOCKPILING OPERATIONS SHALL BE DRY AND STABLE.
2. MAXIMUM SLOPE OF STOCKPILE SHALL BE 2H:1V.
3. UPON COMPLETION OF SOIL STOCKPILING, EACH PILE SHALL BE SURROUNDED WITH EITHER SILT FENCING OR STRAW BALES, THEN STABILIZED WITH VEGETATION OR COVERED.

**ISSUED FOR REVIEW**  
**NOT FOR CONSTRUCTION 05/29/18**

REV.	DESCRIPTION	DATE	BY	CK	APP
B	MEDEP PERMIT SET COMMENT REVISIONS	05/29/18	EVD	KRV	

OWNER ENGINEER:	APPROVAL STAMP:	PE Stamp
DRAWING PREPARED BY:	ACCEPTED BY OE:	

<b>USA ENGINEERING</b> CONFIDENTIAL, PROPRIETARY and TRADE SECRET INFORMATION Property of Iberdrola, USA		 <b>CMP</b> IBERDROLA - USA			
REV.	DATE	BY	DESCRIPTION	APP.	DATE:

<b>SITE DETAILS 4</b> SH 4 OF 5	
<b>FICKETT ROAD/1077</b> POWNAL, ME	
DR. EVD	SCALE: AS NOTED
CK. KRV	FILE: 1077-003-005SH005.DWG
APP.	NO.
<b>1077-003-005</b>	
REV.	B

ANSI D. CADD Drawing. DO NOT REVISE MANUALLY.

**CONSTRUCTION SEQUENCE:**

- ESTABLISH CONSTRUCTION WORKSPACE LIMITS; IDENTIFY AND MARK SENSITIVE RESOURCES.
- PERFORM ALL WORK IN ACCORDANCE WITH MAINE EROSION AND SEDIMENT CONTROL PRACTICES FIELD GUIDE FOR CONTRACTORS (2015).
- PRIOR TO USAGE, CONSTRUCT AND STABILIZE THE CONSTRUCTION ENTRANCE ON THE EXISTING PERMANENT ACCESS ROAD WITH A STONE PAD, MUD RACK, OR OTHER MATERIALS USED TO REDUCE THE TRACKING OR FLOWING OF SEDIMENT OFF THE SITE AND MAINTAIN UNTIL PAVING IS COMPLETED.
- CLEAR TIMBER AND BRUSH; DO NOT GRUB UNTIL JUST PRIOR TO PRELIMINARY GRADING AND ESTABLISHMENT AND STABILIZATION OF TEMPORARY OR PERMANENT DRAINAGE COURSES.
- INSTALL AND MAINTAIN SEDIMENT BARRIERS SUCH AS SILT FENCING AND/OR OTHER EROSION CONTROL BARRIERS ALONG THE DOWNHILL LIMIT OF WORK, AS SHOWN ON THE DRAWINGS. SEDIMENT BARRIER LOCATIONS MAY BE ADJUSTED IN THE FIELD BASED ON SITE CONDITIONS AS DETERMINED BY THE ENGINEERING INSPECTOR. WHERE SILT FENCE CANNOT BE TOED-IN PROPERLY DUE TO TREE ROOTS, ROCKS OR FROZEN GROUND, HAY BALES OR AN EROSION CONTROL MIX BERM MAY BE SUBSTITUTED. SILT FENCING WILL BE INSTALLED AFTER CLEARING BUT PRIOR TO GRUBBING AND GRADING ACTIVITIES. ANY EROSION ISSUES DEVELOPED DURING CLEARING WILL BE TEMPORARILY STABILIZED AS NECESSARY.
- STABILIZE PERMANENT ACCESS ROAD SURFACE, PARKING AREAS AND EQUIPMENT STORAGE AND LAYDOWN AREAS WITH MATTING, CRUSHED STONE OR GRAVEL SUBBASE AS NECESSARY TO MINIMIZE RUTTING AND AVOID PONDING.
- CONCURRENT WITH INITIATION OF SITE GRADING, CONSTRUCT AND STABILIZE TEMPORARY DRAINAGE SWALES, DIVERSION BERMS, CHECK DAMS, AND CULVERTS WITH TEMPORARY INLET AND OUTLET STRUCTURES TO MINIMIZE SEDIMENT IN SITE RUNOFF DURING THE CONSTRUCTION OF THE ROADWAY. DEWATER IN ACCORDANCE WITH DEWATERING NOTES BELOW.
- INSTALL PROPERLY SPACED STONE CHECK DAMS IN ANY SECTION OF DITCH WITHIN 24 HOURS OF FORMING, SHAPING OR ROUGH GRADING THAT SECTION OF DITCH.
- MINIMIZE THE AMOUNT OF DISTURBANCE AT ANY ONE TIME BY STAGING CONSTRUCTION AS MUCH AS PRACTICAL FOR EFFICIENT CONSTRUCTION OF THE FACILITY. NATURAL VEGETATIVE BUFFERS OR STRIPS SHOULD BE LEFT IN PLACE WHERE FEASIBLE TO AID IN SEDIMENT RETENTION AND REDUCE EROSION POTENTIAL.
- STABILIZE ANY NEWLY GRADED SLOPE GREATER THAN EIGHT PERCENT AND ANY SECTION OF NEWLY CONSTRUCTED DITCH USING ANCHORED EROSION CONTROL BLANKETS OR OTHER APPROVED MULCHING TECHNIQUES WITHIN 24 HOURS. STABILIZE ANY SLOPE EXCEEDING EIGHT PERCENT AND BROUGHT TO FINAL GRADE WITHIN 24 HOURS USING ANCHORED EROSION CONTROL BLANKETS OR EROSION CONTROL MIX APPLIED IN ACCORDANCE WITH MAINE EROSION AND SEDIMENT PRACTICES FIELD GUIDE FOR CONTRACTORS (2015). STABILIZE ANY SECTION OF DITCH BROUGHT TO FINAL GRADE WITHIN 24 HOURS USING THE APPROVED PERMANENT STABILIZATION MEASURES FOR DITCHES.
- DUST CONTROL METHODS WILL BE EMPLOYED AFTER GRADING AND PRIOR TO FINAL STABILIZATION TO PREVENT THE BLOWING AND MOVEMENT OF DUST THROUGH THE APPLICATION OF WATER AND/OR CALCIUM CHLORIDE TO REDUCE WIND EROSION. REPETITIVE TREATMENT WILL BE APPLIED AS NEEDED TO ACCOMPLISH CONTROL.
- APPLY TEMPORARY SEED AND MULCH TO ANY EXPOSED AREAS WHERE ACTIVITY IS NOT ANTICIPATED FOR 30 DAYS OR MORE, OR WHERE ACTIVITY HAS NOT OCCURRED WITHIN 30 DAYS. TEMPORARILY MULCH ANY EXPOSED AREAS WHERE ACTIVITY IS NOT ANTICIPATED OR HAS NOT OCCURRED IN 7 DAYS.
- REMOVE EXCESS SPOILS FROM SITE THAT WILL NOT BE USED FOR THE FINAL DESIGN AND STABILIZATION. STOCKPILED SOILS THAT REMAIN IN PLACE FOR 48 HOURS OR MORE WILL BE CONTAINED WITH SEDIMENT BARRIERS SUCH AS SILT FENCE, HAY BALES OR EQUIVALENT. THE SEDIMENT BARRIERS SHALL BE ADEQUATELY LOCATED AND REINFORCED TO HANDLE A SIGNIFICANT RAIN EVENT AND THE POTENTIAL SLUMPING OF THE PILE. BETWEEN MAY 1 AND OCTOBER 15, APPLY TEMPORARY SEED AND MULCH TO A STOCKPILE THAT IS NOT EXPECTED TO BE DISTURBED WITHIN 30 DAYS. APPLY ANCHORED MULCH DAILY, AS NEEDED, DURING WINTER CONSTRUCTION.
- INSPECT AND REPAIR EROSION CONTROL MEASURES DAILY IN AREAS OF ACTIVE CONSTRUCTION; OTHERWISE WEEKLY AND AFTER RAINFALL OF 1/2" OR GREATER WITHIN A 24-HOUR PERIOD. REMOVE ACCUMULATED SEDIMENT WHEN IT REACHES 1/3 THE HEIGHT OF THE BARRIER.
- MONITOR PUBLIC ROADS FOR SIGNS OF TRACKING OR SPILLING OF SPOIL MATERIAL AND CLEAN UP AS NEEDED.
- COMPLETE FINAL GRADING AND STABILIZATION OF EARTHEN STRUCTURES SUCH AS DIVERSION BERMS, DITCH TURNOUTS AND SWALES THAT WILL CONTROL RUNOFF.
- FINISH GRADE AND REPLACE TOPSOIL OR LOAM IN DISTURBED AREAS. SEED AND MULCH DISTURBED AREAS WITHIN 6 DAYS OF FINAL GRADING.
- MAINTAIN ALL TEMPORARY EROSION CONTROLS AND SEDIMENT BARRIERS UNTIL VEGETATION HAS BEEN ESTABLISHED OVER 85-90% OF THE AREA TO BE RE-VEGETATED. RESEED SPARSELY VEGETATED AREAS.
- REMOVE ALL TEMPORARY EROSION AND SEDIMENTATION CONTROL MEASURES ONCE THE SITE IS PERMANENTLY STABILIZED.

**FERTILIZER AND LIMESTONE REQUIREMENTS:**

IN GENERAL, FERTILIZER AND LIME APPLICATION RATES WILL FOLLOW THE GUIDELINES IDENTIFIED BELOW UNLESS SITE SPECIFIC SOIL TESTS IDENTIFY THE NEED FOR ALTERNATIVE FERTILIZER/LIME APPLICATION RATES. FERTILIZER WILL BE APPLIED TO UPLAND AREAS PRIOR TO SEEDING AT A RATE OF 800 POUNDS PER ACRE USING 10-20-20 OR EQUIVALENT. GROUND LIMESTONE (EQUIVALENT TO 50 PERCENT CALCIUM PLUS MAGNESIUM OXIDE) WILL BE APPLIED AT A RATE OF 3 TONS PER ACRE. AN EQUIVALENT MIXTURE OF FERTILIZER AND LIME MAY BE APPLIED USING THE HYDROSEEDING METHOD. NO LIME OR FERTILIZER WILL BE APPLIED TO WETLANDS.

**MULCH AND SEEDING SPECIFICATIONS**

SUMMARY OF TEMPORARY AND PERMANENT MULCH APPLICATION REQUIREMENTS			
CONDITION	TIMING	MULCH TYPE <sup>1,2</sup>	APPLICATION RATES
TEMPORARY			
	IF NO ACTIVITY IN EXPOSED AREAS FOR 7 DAYS, OR PRIOR TO A STORM EVENT	STRAW MULCH OR WOOD FIBER MULCH	2 TONS/ACRES 2000 LB./ACRES
ALL DISTRIBUTED AREAS OF THE CONSTRUCTION WORKSPACE	APPLY MULCH TO ALL EXPOSED AREAS IF NO ACTIVITY OCCURS WITHIN 30 DAYS. APPLY MULCH AND TEMPORARY SEEDING SOONER WHEN IT CAN BE ANTICIPATED THAT ACTIVITY IS NOT GOING TO OCCUR WITHIN 30 DAYS.	STRAW MULCH OR WOOD FIBER MULCH	2 TONS/ACRES 2000 LB./ACRES <sup>3</sup>
ALL WORK AREAS EXPOSED ARE TO BE MULCHED DAILY EACH TIME SOIL IS DISTURBED	OCTOBER 15 - MAY 1	STRAW MULCH OR WOOD FIBER MULCH	3 TONS/ACRES 2000 LB./ACRES
PERMANENT			
ON ALL EXPOSED AREAS AFTER SEEDING TO STABILIZE THE SOIL SURFACE	PERMANENT GRASS AND/OR LEGUME SEEDING COVERED BY HAY OR STRAW MULCH ON ALL AREAS THAT HAVE BEEN RESTORED TO FINAL GRADE. THIS DOES NOT APPLY TO AREAS STABILIZED BY OTHER MEANS SUCH AS JUTE MATTING OR PERMANENT EROSION CONTROL MIX.	CRIMPED STRAW MULCH OR PAPER MULCH OR WOOD FIBER MULCH	2 TONS/ACRES 1500 LB./ACRES <sup>4</sup> 2000 LB./ACRES
WOOD CHIP APPLICATION AREAS	PERMANENT GRASS AND/OR LEGUME SEEDING COVERED BY HAY OR STRAW MULCH ON ALL AREAS THAT HAVE BEEN RESTORED TO FINAL GRADE. THIS DOES NOT APPLY TO AREAS STABILIZED BY OTHER MEANS SUCH AS JUTE MATTING OR PERMANENT EROSION CONTROL MIX.	CRIMPED STRAW MULCH OR PAPER MULCH OR WOOD FIBER MULCH	2 TONS/ACRES 1500 LB./ACRES <sup>4</sup> 2000 LB./ACRES
NOTES: 1. STRAW AND HAY MULCH MAY BE USED INTERCHANGEABLY, EXCEPT IN WETLAND AREAS WHERE STRAW MULCH WILL BE REQUIRED. 2. DOUBLE RATE OF WOOD FIBER MULCH WHEN USED IN CRITICAL AREAS. 3. STRAW, HAY, OR HYDROMULCH (WOOD FIBER OR PAPER MULCH AS APPROPRIATE) WILL PROVIDE 90 PERCENT GROUND COVERAGE 4. PAPER MULCH IS ACCEPTABLE FOR USE DURING THE GROWING SEASON. ON SLOPES GREATER THAN 30 PERCENT AND IN AREAS WHERE VEGETATION HAS NOT ESTABLISHED WELL, ADDITIONAL HAY MULCH WILL BE ADDED AS A WINTERIZING MEASURE.			

**MULCH ANCHORING REQUIREMENTS**

ON SLOPES GREATER THAN 3 PER CENT, HAY OR STRAW MULCH WILL BE FIRMLY ANCHORED INTO THE SOIL UTILIZING ONE OF THE FOLLOWING METHODS:  
 -CRIMPING WITH A STRAIGHT OR NOTCHED MULCH CRIMPING TOOL (FARM DISCS WILL NOT BE ALLOWED);  
 -TRACK WALKING WITH DEEP-CLEATED EQUIPMENT OPERATING UP AND DOWN THE SLOPE (MULCH CRIMPED PERPENDICULAR TO THE SLOPE) ON SLOPES LESS THAN 25 PERCENT;  
 -APPLICATION OF MULCH NETTING;  
 -APPLICATION OF 500 LB./ACRE OF WOOD FIBER MULCH OVER STRAW/HAY MULCH; AND  
 -COMMERCIALY AVAILABLE TACKIFIERS (EXCEPT WITHIN 100 FEET OF WATERBODIES OR WETLANDS).

SUMMARY OF SEEDING REQUIREMENTS		
CONDITION	TIMING <sup>1,2</sup>	SEED MIX
TEMPORARY SEEDING <sup>3</sup>	TEMPORARY SEED BETWEEN MAY 1 AND OCTOBER 15 ONLY. DISTURBED AREAS OR SPOIL STOCKPILES WILL BE SEEDED IMMEDIATELY IF FURTHER DISTURBANCE IS NOT EXPECTED FOR 30 DAYS OR MORE.	ANNUAL RYEGRASS
PERMANENT SEEDING <sup>3,4</sup>		
UPLAND PORTIONS OF THE CONSTRUCTION AREA	DISTURBED AREA WILL BE SEEDED WITHIN 6 DAYS OF FINAL GRADING.	PERMANENT UPLAND MIX
SLOPES GREATER THAN 3:1	DISTURBED AREA WILL BE SEEDED IMMEDIATELY AFTER SEEDBED PREPARATION.	PERMANENT UPLAND MIX
WETLANDS	DISTURBED WETLANDS WILL BE SEEDED WITHIN 6 DAYS OF FINAL GRADING.	ANNUAL RYEGRASS
WOOD CHIP APPLICATION AREAS	DISTURBED AREA WILL BE SEEDED WITHIN 6 DAYS OF FINAL GRADING.	WOODCHIP APPLICATION SEED MIX
WINTER DORMANT SEEDING	DORMANT SEED BETWEEN OCTOBER 15 AND MAY 1 ONLY. NO SEEDING WILL OCCUR IF SNOW DEPTHS EXCEED 1 INCH.	PERMANENT UPLAND MIX PLUS WINTER RYEGRASS
NOTES: 1. WEATHER CONDITIONS PERMITTING. 2. AREAS THAT DO NOT SUCCESSFULLY REVEGETATE WITHIN APPROPRIATE PERIOD OF TIME WILL BE RESEDED AS NECESSARY. 3. LOOSEN COMPACTED SOIL TO A MINIMUM DEPTH OF 4 INCHES. 4. TOP DRESS WITH 6 INCHES LOAM, AS NEEDED.		

SEED MIX SPECIFICATIONS		
SEED MIX NAME	SEED MIX COMPONENTS	LB./ACRE <sup>1</sup>
TEMPORARY SEED MIX	ANNUAL RYEGRASS	40
PERMANENT UPLAND SEED MIX	REDTOP CREEPING RED FESCUE TALL FESCUE BIRDSFOOT TREFLOIL	4 40 40 16
WOOD CHIP APPLICATION SEED MIX	CREEPING RED FESCUE REDTOP TALL FESCUE CROWNVETCH	20 4 30 30
WETLAND SEED MIX	ANNUAL RYEGRASS	40
SUPPLEMENTAL WINTER SEED MIX <sup>2</sup>	WINTER RYEGRASS	120
NOTES: 1. INCREASE SEEDING RATES 10% WHEN HYDROSEEDING 2. WINTER RYE WILL BE ADDED TO PERMANENT UPLAND MIX AT A RATE OF 120 LB./ACRE BETWEEN OCTOBER 15 AND MAY 1		

**ISSUED FOR REVIEW**  
**NOT FOR CONSTRUCTION 05/29/18**

REV.	DESCRIPTION	DATE	BY	CK	APP	OWNER ENGINEER:	APPROVAL STAMP:	PE Stamp	<b>USA ENGINEERING</b> CONFIDENTIAL, PROPRIETARY and TRADE SECRET INFORMATION Property of Iberdrola, USA		SITE DETAILS 5 SH 5 OF 5 FICKETT ROAD/1077 POWNAL, ME		
B	MEDEP PERMIT SET COMMENT REVISIONS	05/29/18	EVD	KRV									
						DRAWING PREPARED BY:	ACCEPTED BY OE:				DR. EVD	SCALE: NONE	FILE: 1077-003-005SH006.DWG
											CK. KRV	NO.	
											APP.		1077-003-005
											REV.		B
											REV. DATE		
											APP. DATE:		

ANSI D CAD Drawing, DO NOT REVISE MANUALLY.

**ATTACHMENT E**  
**Merrill Road Converter Station Stormwater Plan Revisions**

**STORMWATER MANAGEMENT SYSTEM**

**Prepared for the**

**CENTRAL MAINE POWER COMPANY  
MERRILL ROAD CONVERTER SUBSTATION**



**Location**

**Merrill Road  
Lewiston, ME 04240**

**Owner**

**Central Maine Power Company  
83 Edison Drive  
Augusta, Maine 04336**

**Prepared by**



**11733 Chesterdale Road  
Cincinnati, OH 45246  
(513) 326-1500  
September 2017  
REVISED May 2018**

# TABLE OF CONTENTS

<b>INTRODUCTION .....</b>	<b>3</b>
MERRILL ROAD CONVERTER SUBSTATION .....	3
PERMITTING REQUIREMENTS .....	3
<b>BASIC STANDARDS .....</b>	<b>4</b>
EROSION AND SEDIMENTATION CONTROL .....	4
INSPECTION AND MAINTENANCE .....	4
Scheduled Inspections .....	4
As-Needed Maintenance .....	5
5-Year Re-Certification .....	5
HOUSEKEEPING PLAN .....	5
<b>GENERAL STANDARDS .....</b>	<b>6</b>
STORMWATER TREATMENT BMPS .....	6
Crushed Stone Substation Surface .....	6
Grassed Underdrain Soil Filter .....	7
STORMWATER TREATMENT CALCULATIONS .....	7
<b>FLOODING STANDARD .....</b>	<b>7</b>
<b>CONCLUSION .....</b>	<b>9</b>
<b>APPENDIX A – BMP INSPECTION &amp; MAINTENANCE CHECKLISTS AND LOGS .....</b>	<b>10</b>
<b>APPENDIX B – LETTER FROM MEDEP TO CMP .....</b>	<b>11</b>
<b>APPENDIX C – STORMWATER CALCULATIONS .....</b>	<b>12</b>

## **INTRODUCTION**

Central Maine Power Company (CMP) is proposing to construct a new electrical substation as part of the New England Clean Energy Connect (NECEC) Project. The new station will be built on Merrill Road in the town of Lewiston in Androscoggin County, Maine and will be named the Merrill Road Converter Substation.

The proposed electrical substation is located within the Lower Androscoggin Watershed. Site runoff flows north to Stetson Brook, and then heads south into the Androscoggin River. The river then flows downstream to Merrymeeting Bay, then southeast to the Kennebec River and discharges into the Atlantic Ocean.

### **Merrill Road Converter Substation**

The existing conditions and proposed grading plans for the proposed Merrill Road Converter Substation are included with this submission as sheets 1076-003-001 SH 001 General Site Plan Existing Conditions and 1076-003-001 SH 002 General Site Plan Proposed Conditions, respectively. The layout of proposed equipment within the yard is shown on SK-MER-GL Conceptual General Location Plan.

The proposed substation will sit on a 49.5 acre parcel of mostly wooded land that is a mix of somewhat steep terrain and low lying wetlands and includes an existing electric transmission line corridor. The western portion of the site is relatively flat with steeply ascending sloped terrain heading from west to east along the site. The existing transmission line corridor will be the site for a proposed access road to the station. The proposed station pad footprint will be approximately 7.10 acres and will consist of roof top, concrete foundations and pavement impervious and evenly graded 3/4" to 1.5" stone for the remainder of the station pad. The access road will consist of gravel. The station pad site will consist of a total developed area of 10.71 acres, of which, 7.15 acres will be impervious. The access road will include an additional total developed area of 3.69 acres, of which, 1.50 acres will be impervious. The site will be sloped to drain to the north, honoring the existing drainage patterns to the extent practicable. Site and road stormwater runoff will be treated with grassed underdrain soil filters and stormwater detention, while the stoned yard areas are considered to be treated in place.

### **Permitting Requirements**

The Merrill Road Converter Substation is part of the larger NECEC Project currently being undertaken by CMP. The project is submitted as a whole to the Maine Department of Environmental Protection (MeDEP) for permitting purposes.

The project will require a Stormwater Management Permit and a Site Location of Development Permit because more than 3 acres will be stripped or graded and not revegetated within one year, and because the project will occupy more than 20 acres of land. The project will also be required to meet the Basic, General and Flooding Standards as described in MeDEP Chapter 500. The standards will be met using several erosion and sedimentation control and permanent stormwater management Best Management Practices (BMPs).



## **BASIC STANDARDS**

The proposed project will disturb more than one acre of land, requiring compliance with the Basic Standards as described in MeDEP Chapter 500 Section 4B. In order to meet the Basic Standards, the proposed project will be required to address the following:

- Erosion and Sedimentation Control
- Inspection and Maintenance
- Housekeeping

### **Erosion and Sedimentation Control**

Exhibit 14-1 of the Site Law application contains the manual “Central Maine Power Company Environmental Guidelines for Construction and Maintenance Activities on Transmission Line and Substation Projects”. This manual addresses general erosion and sedimentation control measures used in many previous transmission and substation projects and has been reviewed and approved by MeDEP. The manual was developed to be consistent with the Maine Erosion and Sediment Control Practices Field Guide for Contractors, 2015, and MeDEP’s Chapter 500.

Specific erosion and sedimentation control BMPs for the Merrill Road Converter Substation project are indicated on sheet 1076-003-003 SH 001 & SH 002 Erosion and Sediment Control Plan 1 and 2. Details of the measures proposed are shown on sheet 1076-003-005 SH 004 Site Details 4 and sheet 1076-003-005 SH 005 Site Details 5. Sheet 1076-003-005 SH 006 Site Details 6 presents a plan for implementing these measures at the site.

### **Inspection and Maintenance**

CMP will ensure that a qualified design engineer inspects the construction site periodically to verify that the stormwater BMPs are constructed in accordance with the plans and specifications shown on the design drawings, and, as needed, during any period when construction activity affecting the stormwater management system occurs, until the site is permanently stabilized.

Inspection and Maintenance procedures for the proposed substation are described below. BMP Inspection & Maintenance Checklists and BMP Inspection & Maintenance Logs for each site have been enclosed in Appendix A. The BMP Inspection & Maintenance Checklists outline the required inspection frequency/requirements and maintenance/cleanout thresholds for each BMP measure. The enclosed BMP Inspection & Maintenance Logs include specific inspection guidelines for each BMP measure and are the documentation portion of this Plan.

#### ***Scheduled Inspections***

Prior to completion of construction, CMP shall designate a CMP Supervisor and personnel or a contractor as the Site Inspector. Inspection requirements for each individual BMP measure are specified on the Inspection & Maintenance Checklists in Appendix A.

- **QUARTERLY:** Inspections of stormwater conveyance, control and treatment measures at each Site are to be performed on a quarterly basis throughout the year. Inspections during winter months may encounter snow and ice cover, frozen ground, snow embankments, dormant vegetation, etc. In these cases, the inspector must use his/her best judgment interpreting these inspection and maintenance requirements, in order to meet both the stated objectives and the intent of the Plan. The inspection should prevent problems and plan for maintenance in advance of the spring thaw (removing snow piles if they obstruct drainage paths, repairing any damage from snow plows, frost heaves, etc.).
- **FOLLOW-UP:** Additional follow-up inspections will be performed, as needed, depending on the results of routine inspections and site conditions, under the direction of the CMP Supervisor.

### ***As-Needed Maintenance***

Maintenance is to be performed on an as-needed basis, in accordance with recommendations made by the Site Inspector. Routine maintenance will include the immediate repair of eroded channels or gullies; reseeding or sodding of bare ground; removal of trash, leaves and sediment; and control of vegetation. Maintenance issues associated with specific areas and stormwater facilities at each Site are identified on the Inspection & Maintenance Checklists in Appendix A. Disposal of all sediment, debris, and waste shall be in accordance with Maine Solid Waste Management Rules, Chapter 400.

### ***5-Year Re-Certification***

CMP will certify the following to the Maine DEP within three months of the expiration of each five-year interval from the date of issuance of the permit:

- All areas of the project site have been inspected for areas of erosion, and appropriate steps have been taken to permanently stabilize these areas.
- All aspects of the stormwater control system have been inspected for damage, wear, and malfunction, and appropriate steps have been taken to repair or replace the facilities.
- The erosion and stormwater maintenance plan for the site is being implemented as written, or modifications of the plan have been submitted to and approved by the department, and the maintenance log is being maintained.

### **Housekeeping Plan**

Housekeeping entails the control or elimination of pollution not specifically related to soil erosion such as spill prevention, dust control, litter removal and groundwater dewatering. Housekeeping is addressed within this narrative and on sheet 1076-003-005 SH 005 Site Details 6 for the Merrill Road Converter Substation.

## GENERAL STANDARDS

The proposed project will result in more than one acre of new impervious area, requiring compliance with the General Standards as described in MeDEP Chapter 500 Section 4C. For the purposes of determining the level of permitting and treatment required, the substation yard is treated as impervious area.

### Stormwater Treatment BMPs

At the Merrill Road Converter Substation, stormwater treatment will be accomplished using two separate treatment measures.

The approach to the station within the existing transmission line right of way will be a gravel access road and will be drained using open conveyance channels. Runoff from the road, up to within 50 feet of the substation, will be treated to meet the requirements under *Section 4.C (5) (C) - Exceptions from the general standards for Linear portion of a project*. The majority of the gravel access road, vegetated developed areas and the drainage ditch running east and west on the north side of the road, will be treated using a grassed underdrain soil filter with grassed swale and forebay pre-treatment.

The substation yard will be treated in-place via filtration through an 18"-thick layer of gravel below the stone surface. This *Crushed Stone Substation Surface* is approved by MeDEP as an adequate treatment for the yard surface for compliance with the General Standards and water quality treatment requirement. Additional paved and rooftop surfaces and additional developed areas around the yard will also be treated in the *Crushed Stone Substation Surface*. Developed areas outside the substation pad will discharge to open drainage channels around the station pad which will flow to a single *Underdrained Soil Filter* where additional detention will be provided. The soil filter/detention basin will discharge through a level spreader to the north of the station. Runoff from the station pad does not require detention and will bypass the soil filter and detention by sheet flowing to the proposed catch basin outside of the soil filter area to the north of the pad. The catch basin will also discharge through a level spreader to the north of the substation. The stormwater treatment measures, and the areas that are treated by each, are depicted on sheet 1076-003-002 SH 004 Post-Development Stormwater Plan.

### *Crushed Stone Substation Surface*

MeDEP has provided yard construction requirements that allow the General Standards requirements to be met for the substation pad, and no further water quality treatment of stormwater from the pad itself is required. The MeDEP letter describing the construction requirements is included with this submission as Appendix B.

The substation surface for each yard is comprised of crushed stone. The crushed stone is supported by 18" of gravel base which acts to filter stormwater runoff as it passes through and into the soil subgrade below. The typical crushed stone surface section is shown in the Substation Yard Sections on sheet 1076-003-005 SH 001 Site Details 1 for the Merrill Road Converter Substation.

In each yard, an additional 2" of crushed stone above the 4" requirement will be provided, creating a 6" layer. The additional storage in the crushed stone layer down slope of the buildings, paved areas and various concrete foundations throughout the yard will allow the crushed stone surface to treat

each of these non-soil areas. Calculations for treatment of runoff from the pad have been provided on sheet 1076-003-002 SH 004 Post-Development Stormwater Plan for the Merrill Road Converter Substation. Groundwater dewatering has been addressed with a system of perforated piping, which runs below the frost line in the excavated region of the station pad and around the foundation of the equipment enclosure. The groundwater dewatering system is designed to prevent the migration of groundwater into the 6" station crushed stone and 18" gravel base.

### ***Grassed Underdrain Soil Filter***

Runoff from the vegetated developed areas as well as the gravel access road will be treated in Grassed Underdrain Soil Filters. Pretreatment will be accomplished by flowing runoff through a vegetated swale and into pre-treatment forebays before entering the filter area.

The Grassed Underdrain Soil Filter is comprised of an 18"-thick layer of a silty sand and organic material mix. The underdrain system consists of 4" perforated pipe within a 12"-thick layer of underdrain material. A detail of the underdrained soil filter is shown on sheet 1076-003-002 SH 002 Stormwater Treatment Plan. Included with soil filters are orifices which discharge the treatment volume from a single outlet with a release time between 24 and 48 hours. Underdrained soil filter sizing and orifice calculations are shown in Appendix C.

The hydraulic modeling report for the entire project site, including station and access road, is included with this submission in Appendix C. The report was developed based on USDA TR-55 hydraulic analysis methodology. The report illustrates how the site drainage and stormwater management infrastructure will function during the 2-, 10- and 25-year storms. The report also contains the hydrologic calculations for the project. The modeling results were used to confirm that adequate water quality volume (WQV) will be provided below the primary outlet, a broad crested weir constructed in the outlet structure.

### **Stormwater Treatment Calculations**

In order to meet the General Standards, the proposed project must use MeDEP approved treatment measures to treat no less than 95% of the proposed impervious area and 80% of the proposed developed area at the substation site. At the Merrill Road Converter Substation, 99.33% of impervious area is treated, and 83.75% of the developed area is treated. For the linear portion of the project treatment has been reduced to not less than 75% of impervious access road and no less than 50% of the developed area surrounding the road to within 50' of the substation. At the linear portion of the Merrill Road Converter Substation, 75.10% of impervious area is treated, and 59.89% of developed area is treated. Stormwater treatment calculations for the Merrill Road Converter Substation are shown on sheet 1076-003-002 SH 004 Post-Development Stormwater Plan.

### **FLOODING STANDARD**

The project is required to meet the MeDEP Chapter 500 Flooding Standard; an increase of over 3 acres of impervious area requires a decrease in peak stormwater runoff as a result of the proposed development. Additionally, management of stormwater to prevent site and road inundation during a 25-year storm event is provided. The site is situated on HSG Type C and Type D soils. Pre-developed and post-developed Curve Numbers for the project can be found in Appendix C and on the project drainage area maps (Sheets 1076-003-002 SH 003 and SH 004). The MeDEP letter describing the

construction requirements that allow the General Standards requirements to be met for the pad within the **Crushed Stone Substation Surface** also prescribes Curve Numbers for use when calculating runoff from the stone section. Pre-Developed Curve Numbers for the project site range from 72 to 77. MeDEP prescribes developed Curve Numbers for the stone station surface of 55 and 60 over HSG Type C and Type D soils respectively. As existing drainage patterns have been maintained to the extent practicable, the sizes and times of concentration have not been significantly altered with this project. Due to the decreased Curve Numbers across the stone station pad (CN decreased to 55 and 60 for these areas), post-development peak flows were calculated to be less than or relatively equal to the pre-development peak flows from the substation pad without the need for on-site stormwater attenuation. In order to maintain a post-development peak runoff rate at or below the pre-development peak runoff rate for developed landscaped areas outside the pad however, some level of stormwater detention is required. Additional stormwater storage is provided in the grassed underdrain soil filter. A maximum of 18” of flooding storage depth above the required water quality volume elevations in the grassed underdrain soil filters is proposed. The proposed on-site stormwater detention will provide sufficient capacity to meet the MeDEP Flooding Standard Requirements in Chapter 500 at each analysis point, located at the property line. At each analysis point, stormwater detention on the **Crushed Stone Substation Surface** provides enough treatment to decrease post-development 2 -, 10 – and 25 – year design storm peak flows to be lower than pre-development peak flows. See the table below for the pre- and post-development peak flows at each analysis point.

#### Pre-Developed Peak Flow Rates

Analysis Point	2-Year Flow Rate (CFS)	10-Year Flow Rate (CFS)	25-Year Flow Rate (CFS)
A	11.40	27.00	35.56
B	4.94	11.30	14.75
C	6.00	14.87	19.86
D	0.72	1.58	2.04
E	3.22	7.13	9.23

#### Post-Developed Peak Flow Rates

Analysis Point	2-Year Flow Rate (CFS)	10-Year Flow Rate (CFS)	25-Year Flow Rate (CFS)	Peak 2-Year Flow Rate at Outfall (If Subsheds Present)	Peak 10-Year Flow Rate at Outfall (If Subsheds Present)	Peak 25-Year Flow Rate at Outfall (If Subsheds Present)
A1	5.17	12.68	16.85	11.36	23.26	31.36
A2	7.78	15.58	19.64			
A3	2.90	7.30	9.76			
B	3.50	7.98	10.41	N/A		
C1	5.97	14.63	19.48	5.96	14.84	19.83
C2	2.25	4.39	5.50			
D	0.56	1.24	1.61	N/A		
E	2.68	5.91	7.65	N/A		

## **CONCLUSION**

The NECEC Project will require a Stormwater Management Permit, and will be required to meet the Basic and General Standards and the Flooding Standard as described in MeDEP Chapter 500. The Basic Standards shall be met at the Merrill Road Converter Substation through Erosion and Sedimentation Control, Inspection and Maintenance, and Housekeeping, as described in this narrative and the attached checklists, logs and plans. The General Standards shall be met at the Merrill Road Converter Substation by using Grassed Underdrain Soil Filters and the MeDEP approved crushed stone substation yard section, as illustrated on the attached stormwater treatment plans. The Flooding Standard shall be met using storage above the water quality volume within the proposed Grassed Underdrain Soil Filters.

# **APPENDIX A – BMP INSPECTION & MAINTENANCE CHECKLISTS AND LOGS**

## APPENDIX A-1: BMP INSPECTION & MAINTENANCE CHECKLIST

Central Maine Power Company – Merrill Road Converter Substation  
Lewiston, Maine

BMP MEASURE	INSPECTION REQUIREMENTS*	MAINTENANCE/CLEANOUT THRESHOLDS
Vegetated Swales	<p>Inspect swale for accumulated sediment, debris and other obstructions.</p> <p>Inspect swales for evidence of erosion, gullies, or slumping of the side slopes.</p> <p>Inspect swales for bare ground/sparse vegetation.</p> <p>Monitor vegetative growth.</p>	<p>Clean as needed and dispose of properly.</p> <p>Repair and re-seed as necessary. Consult engineer if problem persists. Areas of persistent erosion may need to be armored.</p> <p>Re-seed as necessary. Soil may need to be scarified if compacted soils are present.</p> <p>Mow vegetation in swales to roughly six inches at least once and no more than two times a year. To be performed between June 15<sup>th</sup> and August 30<sup>th</sup>.</p>
Check Dams	<p>Inspect check dams to ensure the center is lower than the edges.</p> <p>Inspect check dams for stone displacement, erosion, concentrated flow or channelization.</p> <p>Inspect check dams for accumulated sediment, debris or other obstructions.</p>	<p>Repair as necessary.</p> <p>Repair any damaged areas. Consult engineer if problem persists.</p> <p>Clean as needed and dispose of properly. Sediment must be removed before it exceeds one half the original height of the check dam.</p>
Revegetated Areas	<p>Inspect revegetated areas for evidence of erosion, concentrated flow, or channelization.</p> <p>Inspect revegetated areas for bare ground/sparse vegetation.</p>	<p>Repair and re-seed as necessary. Consult engineer if problem persists. Areas of concentrated flow where rills and gullies are present may need to be armored</p> <p>Re-seed as necessary. Soil may need to be scarified if compacted soils are present.</p>
Gravel Access Roads	<p>Inspect access road shoulder for accumulated sand/sediment.</p> <p>Inspect grade on access road and shoulder to ensure stormwater is not impeded by accumulation of materials or false ditches.</p> <p>Inspect access road to ensure that there is no rutting, wash-boarding, frost heaves, potholes, or ponding occurring.</p>	<p>Remove sand/sediment as necessary.</p> <p>Repair grade as necessary.</p> <p>Repair by replacing gravel and re-grading as necessary.</p>

\*Inspections are to be performed on a monthly basis with additional follow-up inspections and maintenance as needed.



**APPENDIX A-1: BMP INSPECTION & MAINTENANCE CHECKLIST**

Central Maine Power Company – Merrill Road Substation  
Lewiston, Maine

BMP MEASURE	INSPECTION REQUIREMENTS*	MAINTENANCE/CLEANOUT THRESHOLDS
Grassed Underdrained Soil Filter	<p>Inspect entering swale, basin and outlet structure for accumulated sediment, debris and other obstructions.</p> <p>Inspect filter for evidence of erosion, gullies, or slumping of the side slopes.</p> <p>Inspect filter for bare ground/sparse vegetation.</p> <p>Monitor vegetative growth.</p>	<p>Clean as needed and dispose of properly.</p> <p>Repair and re-seed as necessary. Consult engineer if problem persists. Areas of persistent erosion may need to be armored.</p> <p>Re-seed as necessary. Soil may need to be scarified if filter media becomes compacted.</p> <p>Mow vegetation in impoundment to roughly six inches at least once and no more than two times a year. To be performed between June 15<sup>th</sup> and August 30<sup>th</sup>.</p>
Crushed Stone Substation Surface	<p>Inspect crushed stone areas for accumulated sand/sediment.</p> <p>Inspect substation surface to ensure that there is no ponding occurring.</p>	<p>Remove sand/sediment as necessary.</p> <p>Repair by re-grading as necessary.</p>

\*Inspections are to be performed on a monthly basis with additional follow-up inspections and maintenance as needed.

**APPENDIX A-2: BMP INSPECTION & MAINTENANCE LOG**  
 Central Maine Power Company – Merrill Road Converter Substation  
 Lewiston, Maine

<b>BMP MEASURE</b> (Refer to Appendix B-1 & the O&M Plan)	<b>Inspector(s):</b>			<b>Inspection Type:</b> Monthly [ ] Follow-up [ ]	<b>Photos Taken:</b> Yes [ ] No [ ]	<b>Date:</b>
	<b>YES*</b>	<b>NO</b>	<b>INITIALS</b>	<b>OBSERVATIONS</b>	<b>CORRECTIVE ACTIONS/REPAIR ACTIVITY</b>	<b>DATE COMPLETED &amp; BY WHOM</b> (Refer to any contractor service logs)
<b>VEGETATED SWALES</b>						
<b>Swale along Gravel Access Road</b>						
1. Is there an accumulation of sediment, debris and/or other obstructions?						
2. Is there any evidence of erosion, gullies or slumping of the side slopes?						
3. Are there areas of bare ground or sparse vegetation?						
4. Has vegetation been mowed to a length roughly 6" this year?						
<b>Swale along Northwesterly side of yard</b>						
1. Is there an accumulation of sediment, debris and/or other obstructions?						
2. Is there any evidence of erosion, gullies or slumping of the side slopes?						
3. Are there areas of bare ground or sparse vegetation?						
4. Has vegetation been mowed to a length roughly 6" this year?						
<b>CHECK DAMS</b>						
<b>Check Dams in Swale along Gravel Access Road</b>						
1. Are the edges of the check dams higher than the center?						
2. Is there any evidence of stone displacement, erosion, concentrated flow or channelization?						
3. Is there an accumulation of sediment, debris and/or other obstructions?						

**APPENDIX A-2: BMP INSPECTION & MAINTENANCE LOG**  
 Central Maine Power Company – Merrill Road Converter Substation  
 Lewiston, Maine

<b>BMP MEASURE</b> (Refer to Appendix B-1 & the O&M Plan)	<b>Inspector(s):</b>			<b>Inspection Type:</b> Monthly [ ] Follow-up [ ]	<b>Photos Taken:</b> Yes [ ] No [ ]	<b>Date:</b>
<b>CHECK DAMS (cont.)</b>	<b>YES*</b>	<b>NO</b>	<b>INITIALS</b>	<b>OBSERVATIONS</b>	<b>CORRECTIVE ACTIONS/REPAIR ACTIVITY</b>	<b>DATE COMPLETED &amp; BY WHOM</b> (Refer to any contractor service logs)
<b>Check Dams in Swale along North, South and East sides of the yard</b>						
1. Are the edges of the check dams higher than the center?						
2. Is there any evidence of stone displacement, erosion, concentrated flow or channelization?						
3. Is there an accumulation of sediment, debris and/or other obstructions?						
<b>REVEGETATED AREAS</b>						
<b>Revegetated Areas along Access Road</b>						
1. Is there any evidence of erosion, concentrated flow or channelization?						
2. Are there areas of bare ground or sparse vegetation?						
<b>Revegetated Areas on all sides of the station</b>						
1. Is there any evidence of erosion, concentrated flow or channelization?						
2. Are there areas of bare ground or sparse vegetation?						
<b>GRAVEL ACCESS ROADS</b>						
<b>Access Road to Entrance</b>						
1. Is there an accumulation of sand and/or sediment in the road shoulder?						
2. Does the grade across the road section allow stormwater to drain off the roadway?						
3. Are there any signs of rutting, wash-boarding, frost heaves, potholes or ponding?						

**APPENDIX A-2: BMP INSPECTION & MAINTENANCE LOG**  
 Central Maine Power Company – Merrill Road Converter Substation  
 Lewiston, Maine

<b>BMP MEASURE</b> (Refer to Appendix B-1 & the O&M Plan)	<b>Inspector(s):</b>			<b>Inspection Type:</b> Monthly [ ] Follow-up [ ]	<b>Photos Taken:</b> Yes [ ] No [ ]	<b>Date:</b>
<b>GRASSED UNDERDRAINED SOIL FILTER</b>	<b>YES*</b>	<b>NO</b>	<b>INITIALS</b>	<b>OBSERVATIONS</b>	<b>CORRECTIVE ACTIONS/REPAIR ACTIVITY</b>	<b>DATE COMPLETED &amp; BY WHOM</b> (Refer to any contractor service logs)
<b>West side of station yard and north of Access Road</b>						
1. Is there an accumulation of sand and/or sediment in the swale or basin?						
2. Is there any evidence of erosion, gullies or slumping of the side slopes?						
3. Are there areas of bare ground or sparse vegetation?						
<b>CRUSHED STONE SUBSTATION SURFACE</b>						
<b>Fenced-in area of the Substation and aprons</b>						
1. Is there an accumulation of sand/sediment in crushed stone areas?						

## **APPENDIX B – LETTER FROM MEDEP TO CMP**



STATE OF MAINE  
DEPARTMENT OF ENVIRONMENTAL PROTECTION

JUN 11 2008

JOHN ELIAS BALDACCI  
GOVERNOR

DAVID P. LITTELL  
COMMISSIONER

June 5, 2008

Roy Koster  
Central Maine Power  
83 Edison Drive  
Augusta, ME 04336

RE: DEP Stormwater Management Regulations and how they apply to  
Central Maine Power Company Substations and Switchyards

Dear Mr. Koster:

I am writing to provide clarification on how substations and switchyards designed by Central Maine Power Company (CMP) can meet DEP Stormwater Management rules, Chapter 500 and the Site Location of Development Law. This letter supersedes a previous DEP letter on this subject dated February 29, 2008 and is a follow-up to further discussions between CMP and DEP staff.

Based on the report prepared by John Simon of Balance Engineering, dated March 8, 2008, regarding the stormwater runoff coefficient at CMP substations and switchyards, the required gravel fill and surface nature of these structures performs differently than most common construction practices and a modeling variance will be allowed for CMP substations and switchyards as follows:

When Flooding Standard requirements apply to a CMP project, modeling must demonstrate that peak runoff from the substation structure does not exceed predevelopment flow rates at the property line. Because of the permeability plus storage within the gravel fill and roughness of the crushed rock surface, the curve number (CN) specified in John Simon's report (March 2008) may be used for the substation area. As reported, a CN of 55 may be used for substations and switchyards that are built on areas that are mapped as HSG "A", "B", and "C", and a CN of 60 must be used when the area is mapped as HSG "D" for the HydroCAD model. However, all impervious surfaces will have to be added for an averaged curve number.

The General Standards of Chapter 500 (water quality) will be considered as met by the CMP substation/switchyard design specifications as long as the structure includes the typical CMP substation profile overlaying the natural ground surface. The soil layers within the CMP substation profile consist of 4 inches of crushed stone, 50:50 mix of 1.5"

AUGUSTA  
17 STATE HOUSE STATION  
AUGUSTA, MAINE 04333-0017  
(207) 287-7688 FAX: (207) 287-7826  
RAY BLDG., HOSPITAL ST.

BANGOR  
106 HOGAN ROAD  
BANGOR, MAINE 04401  
(207) 941-4570 FAX: (207) 941-4584

PORTLAND  
312 CANCO ROAD  
PORTLAND, MAINE 04103  
(207) 822-6300 FAX: (207) 822-6303

PRESQUE ISLE  
1235 CENTRAL DRIVE, SKYWAY PARK  
PRESQUE ISLE, MAINE 04769-2094  
(207) 764-0477 FAX: (207) 760-3143

and 0.75" diameter stone overlaying 18 inches or more of gravel fill, MDOT 703.06 Type A. Saturation within the granular fill will detain and provide treatment for the one-inch design standard under that requirement. Groundwater can never be any higher than 18 inches below the top of the gravel fill. Other treatment considerations will need to be provided for all impervious structures anticipated on the substation and switchyard and for the roadway.

The Basic Standards of Chapter 500 (erosion and sedimentation control, inspection and maintenance, and housekeeping) will be met by the standard CMP substation and switchyard design specification and erosion control/construction plan as developed by CMP for each Stormwater Management application. These are minimum erosion control measures that will need to be maintained until the site is fully stabilized. However, based on site and weather conditions during construction, additional erosion control measures may be needed.

While there are several ways to approach the design standards discussed above, these must be considered the minimum requirements in meeting the Stormwater Management and Site Location of Development Laws. However, in some situations where the local hydrology and site conditions warrant more resource protection, additional BMPs may be required. Also, the access drive and associated roadside swales are included in the disturbed area for permitting purposes and the treatment of these areas must be addressed separately from the substation or switchyard and be treated with standard practices. The natural hydrology of these areas will need to be maintained and will have to meet all applicable standards as established in Chapter 500 (page 11, Section 5).

I hope this addresses your request and will make the DEP permitting process more straight forward. If you have further questions, please contact Marianne Hubert at (207) 287-4140.

Sincerely,

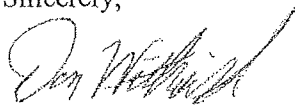

Don Witherill, Director  
Watershed Management Division  
Bureau of Land and Water Quality

Cc: Marianne Hubert, PE, DEP program manager  
Andy Fisk, DEP L&W Bureau Director  
Dan Butler, PE, TRC  
Gerry Mirabile, CMP

## APPENDIX C – STORMWATER CALCULATIONS



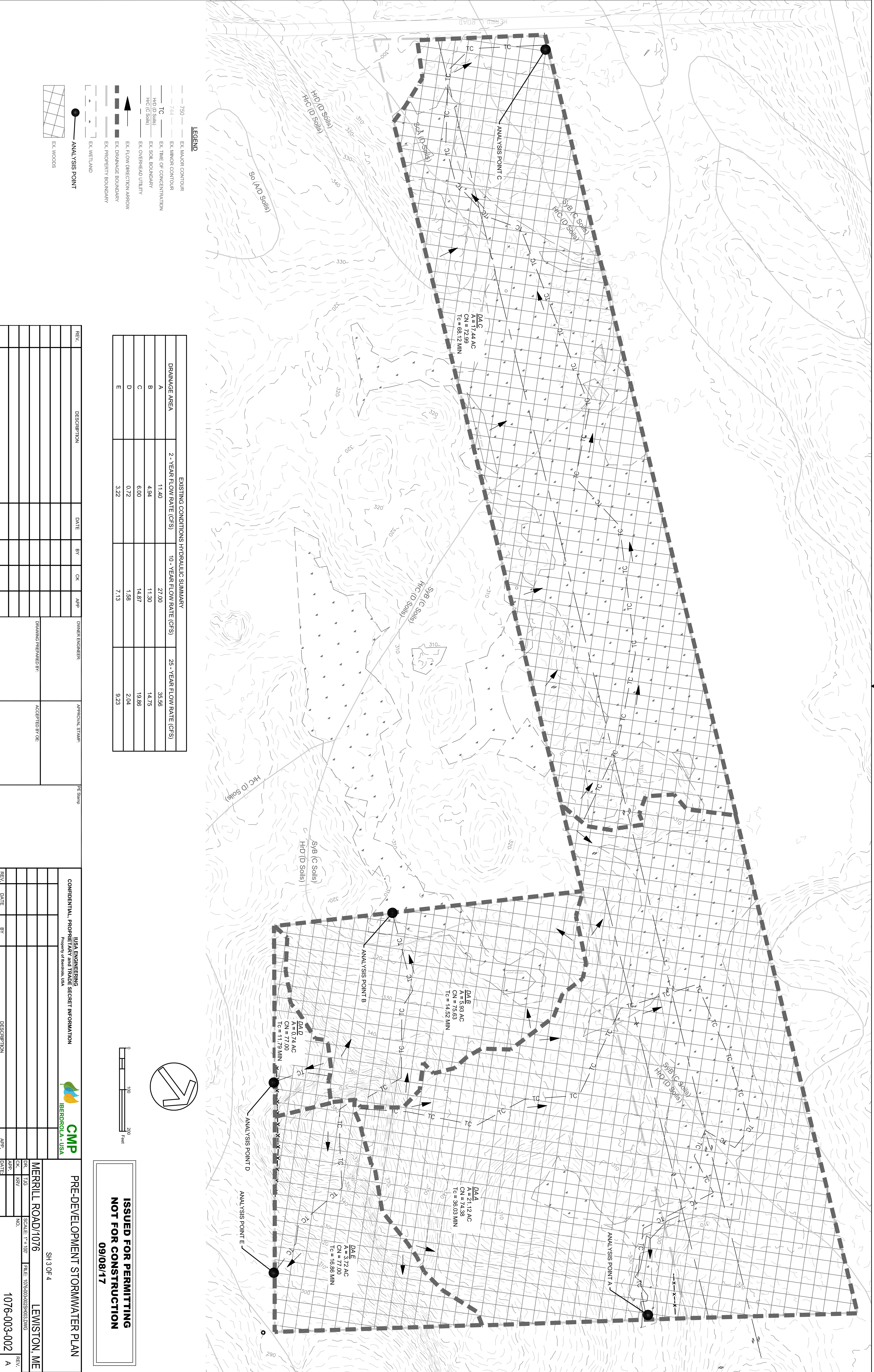

**LEGEND**

- 750 — EX. MAJOR CONTOUR
- 744 — EX. MINOR CONTOUR
- TC — EX. TIME OF CONCENTRATION
- HIC (D Soils) — EX. SOIL BOUNDARY
- HIC (C Soils) — EX. OVERHEAD UTILITY
- ▲— EX. FLOW DIRECTION ARROW
- ▲— EX. DRAINAGE BOUNDARY
- ▲— EX. PROPERTY BOUNDARY
- ▲— EX. WETLAND
- ANALYSIS POINT
- EX. WOODS

**EXISTING CONDITIONS HYDRAULIC SUMMARY**

DRAINAGE AREA	2 - YEAR FLOW RATE (CFS)	10 - YEAR FLOW RATE (CFS)	25 - YEAR FLOW RATE (CFS)
A	11.40	27.00	35.56
B	4.94	11.30	14.75
C	6.00	14.87	19.86
D	0.72	1.58	2.04
E	3.22	7.13	9.23

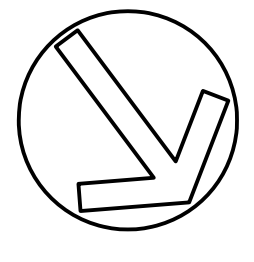
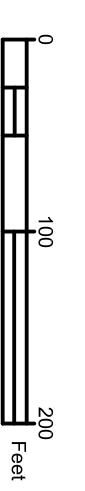

**ISSUED FOR PERMITTING  
NOT FOR CONSTRUCTION  
09/08/17**

REV.	DESCRIPTION	DATE	BY	CK	APP	OWNER ENGINEER	APPROVAL STAMP	FE Stamp

**CONFIDENTIAL, PROPRIETARY and TRADE SECRET INFORMATION**

USA ENGINEERING  
SECRET INFORMATION  
Property of Berndrola, USA

**PRE-DEVELOPMENT STORMWATER PLAN**

SH 3 OF 4

MERRILL ROAD/1076 LEWISTON, ME

SCALE: 1" = 100'

FILE: 1076-003-002\$H03.DWG

NO. 1076-003-002

REV. A



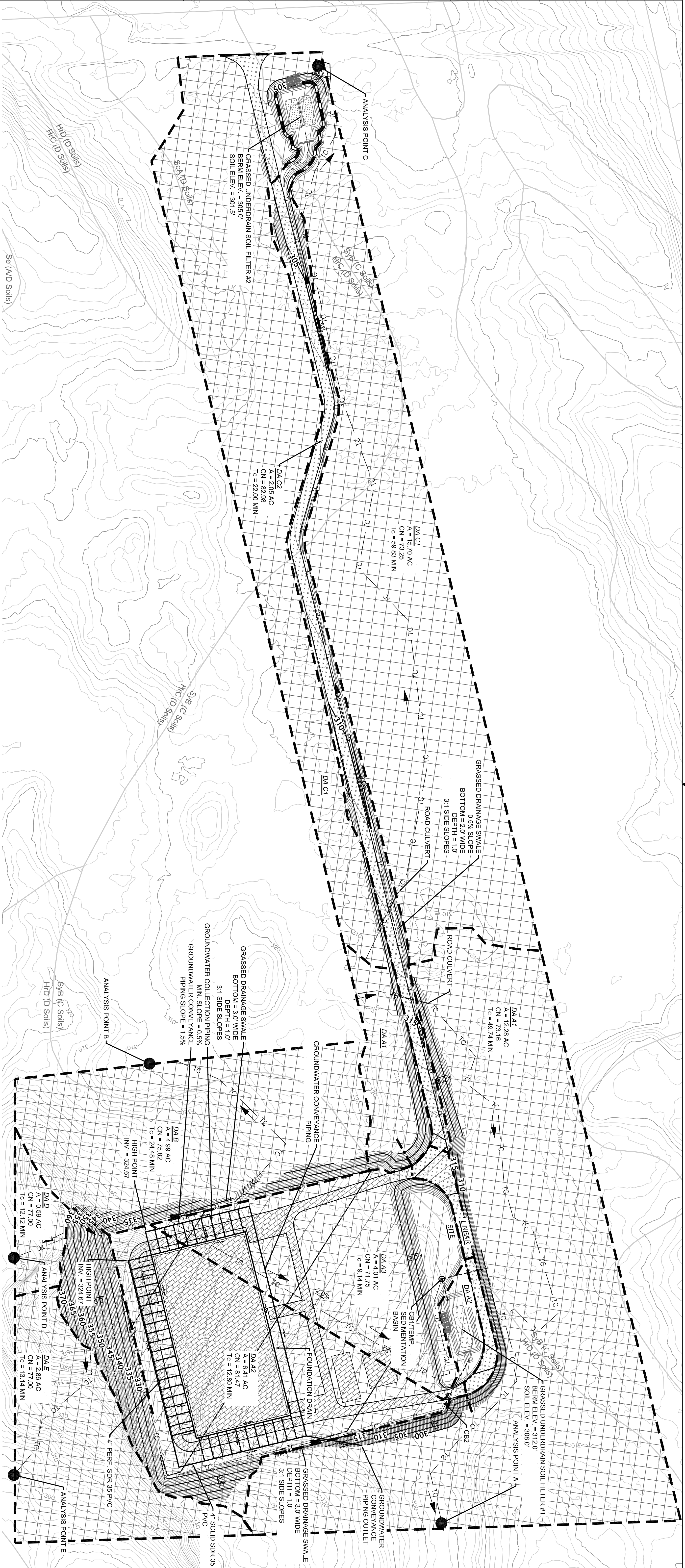

**LEGEND**

750	EX. MAJOR CONTOUR	750	PROP. MAJOR CONTOUR
744	EX. MINOR CONTOUR	744	PROP. MINOR CONTOUR
HrD (D Soils)	EX. SOIL BOUNDARY	TC	PROP. TIME OF CONCENTRATION
HrC (C Soils)	EX. OVERHEAD UTILITY	▲	PROP. FLOW DIRECTION ARROW
---	EX. PROPERTY BOUNDARY	---	PROP. DRAINAGE BOUNDARY
---	EX. WETLAND	●	ANALYSIS POINT
		---	PROP. CULVERT/PIPING
		---	PROP. SITE/LINEAR DEMARCATION

**PROPOSED CONDITIONS HYDRAULIC SUMMARY**

DRAINAGE AREA	2-YEAR FLOW RATE (CFS)	10-YEAR FLOW RATE (CFS)	25-YEAR FLOW RATE (CFS)	PEAK 2-YEAR FLOW RATE AT ANALYSIS POINT (IF SUBSHEDS PRESENT)	PEAK 10-YEAR FLOW RATE AT ANALYSIS POINT (IF SUBSHEDS PRESENT)	PEAK 25-YEAR FLOW RATE AT ANALYSIS POINT (IF SUBSHEDS PRESENT)
A1	5.17	12.68	16.85		11.36	31.36
A2	7.78	15.58	19.64		23.26	
A3	2.90	7.30	9.76		N/A	N/A
B	3.50	7.98	10.41		N/A	N/A
C1	5.97	14.63	19.48	5.96	14.84	19.83
C2	2.25	4.39	5.50		N/A	N/A
D	0.56	1.24	1.61		N/A	N/A
E	2.88	5.91	7.65		N/A	N/A

**STORMWATER TREATMENT REQUIREMENTS (% OF TREATED AREA)**

LAND TYPE	STATION	STATION % TREATED	LINEAR	LINEAR % TREATED
IMPERVIOUS TOTAL	7.15 AC	99.33%	1.50 AC	75.10%
IMPERVIOUS TREATED	7.10 AC		1.13 AC	
DEVELOPED TOTAL	10.71 AC		3.69 AC	
DEVELOPED TREATED	8.97 AC	83.75%	2.21 AC	59.88%

DEVELOPED AREA INCLUDES BOTH IMPERVIOUS AND LANDSCAPED SURFACES

REV.	DESCRIPTION	DATE	BY	CK	APP	OWNER ENGINEER
B	MEDEP PERMIT SET COMMENT REVISIONS	05/29/18	TJG	KRV		

REV.	DATE	BY	DESCRIPTION

REV.	DATE	BY	DESCRIPTION

REV.	DATE	BY	DESCRIPTION

REV.	DATE	BY	DESCRIPTION

REV.	DATE	BY	DESCRIPTION

**ISSUED FOR PERMITTING  
NOT FOR CONSTRUCTION  
05/29/18**

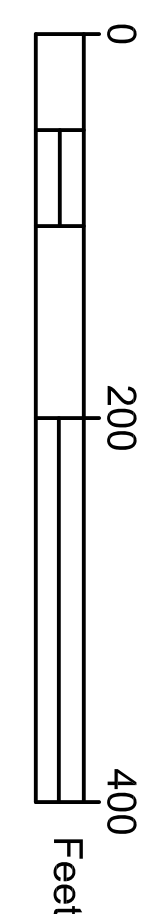

POST-DEVELOPMENT STORMWATER PLAN

SH 4 OF 4

MERRILL ROAD/1076 LEWISTON, ME

USA ENGINEERING  
PROPERTY OF IBERDROLA, USA  
1076-003-002



Calculations for Grassed Underdrain Soil Filters						
*Based upon MeDEP Stormwater BMPs Chapter 7.1 - Grassed Underdrain Soil Filters						
Name of Filter	Impervious Catchment (AC)	Pervious Developed Catchment (AC)	Surface Area Required (SF)	<sup>1</sup> Designed Surface Area of Filter (SF)	WQv Required (CF)	<sup>2</sup> WQv Provided (CF)
Filter-1	0.17	1.87	1999.404	2178	3332.34	3542
Filter-2	0.97	1.08	3053.556	3106	5089.26	6065

<sup>1</sup>Filter-2 consists of two (2) 1553 SF filter beds, totalling 3106 SF of surface area

<sup>2</sup>Filter-1 WQv depth = 1.10', Filter-2 WQv depth = 1.25'

Calculations for Grassed Underdrain Soil Filters							
Orifice Sizing, Underdrain Detention							
Name of Filter	WQv Required (CF)	Detention Time (HR)	Flow Rate (CFS)	Average Head (FT)	Orifice Coefficient	Orifice Area (SF)	Orifice Diameter (IN) <sup>3</sup>
Filter-1	3332.34	36	0.0257125	1.92	0.614	0.003766018	0.830954986
Filter-2	5089.26	36	0.039268981	1.97	0.614	0.005678129	1.020325909

<sup>3</sup>Constructed Filter-1 Orifice Diameter = 7/8", Filter-2 Orifice Diameter = 1.00" to allow detention time between 24 - 48 hrs

Calculations for Level Spreaders			
*Based Upon MeDEP Storm water BMPs Chapter 8.3 - Level Spreaders			
Level Spreader #	Peak 10-Year Flow Rate	<sup>1</sup> Calculated Lip Length (LF)	<sup>2</sup> Lip Length Used (LF)
1	0.36	1.44	10
2	<sup>3</sup> 2.00	8.00	10
3	1.84	7.36	10
4	2.19	8.76	10
<sup>4</sup> Pipe Outlet Protection from CB-1	19.04	76.16	N/A

<sup>1</sup> Lip Length Based Upon 0.25 LF / CFS

<sup>2</sup> Based Upon Minimum Lip Length of 10 LF

<sup>3</sup> 2 cfs (Approx ¼ of DA B)

<sup>4</sup> Plunge pool designed in accordance with MeDEP Erosion Control BMPs H.2 Pipe Outlet Protection

## Project Description

File Name ..... Existing Conditions.SPF

## Project Options

Flow Units ..... CFS  
 Elevation Type ..... Elevation  
 Hydrology Method ..... SCS TR-55  
 Time of Concentration (TOC) Method ..... SCS TR-55  
 Link Routing Method ..... Kinematic Wave  
 Enable Overflow Ponding at Nodes ..... YES  
 Skip Steady State Analysis Time Periods ..... NO

## Analysis Options

Start Analysis On ..... Jul 13, 2017 00:00:00  
 End Analysis On ..... Jul 14, 2017 00:00:00  
 Start Reporting On ..... Jul 13, 2017 00:00:00  
 Antecedent Dry Days ..... 0 days  
 Runoff (Dry Weather) Time Step ..... 0 01:00:00 days hh:mm:ss  
 Runoff (Wet Weather) Time Step ..... 0 00:05:00 days hh:mm:ss  
 Reporting Time Step ..... 0 00:05:00 days hh:mm:ss  
 Routing Time Step ..... 30 seconds

## Number of Elements

	Qty
Rain Gages .....	1
Subbasins.....	5
Nodes.....	5
<i>Junctions</i> .....	0
<i>Outfalls</i> .....	5
<i>Flow Diversions</i> .....	0
<i>Inlets</i> .....	0
<i>Storage Nodes</i> .....	0
Links.....	0
<i>Channels</i> .....	0
<i>Pipes</i> .....	0
<i>Pumps</i> .....	0
<i>Orifices</i> .....	0
<i>Weirs</i> .....	0
<i>Outlets</i> .....	0
Pollutants .....	0
Land Uses .....	0

## Rainfall Details

SN	Rain Gage ID	Data Source	Data Source ID	Rainfall Type	Rain Units	State	County	Return Period (years)	Rainfall Depth (inches)	Rainfall Distribution
1	Rain Gage-01	Time Series	TS-02	Cumulative	inches	Maine	Androscoggin	2	3.00	SCS Type III 24-hr

## Subbasin Summary

Subbasin ID	Area (ac)	Weighted Curve Number	Total Rainfall (in)	Total Runoff (in)	Total Runoff Volume (ac-in)	Peak Runoff (cfs)	Time of Concentration (days hh:mm:ss)
A	21.12	74.38	3.00	0.93	19.60	11.40	0 00:36:01
B	5.93	75.63	3.00	1.00	5.90	4.94	0 00:14:31
C	17.44	72.99	3.00	0.86	14.95	6.00	0 01:08:07
D	0.74	77.00	3.00	1.07	0.79	0.72	0 00:11:47
E	3.72	77.00	3.00	1.07	3.98	3.22	0 00:16:51

## Node Summary

Element ID	Element Type	Invert Elevation
---------------	-----------------	---------------------

(ft)		
OUT-A	Outfall	298.00
OUT-B	Outfall	310.00
OUT-C	Outfall	298.00
OUT-D	Outfall	338.00
OUT-E	Outfall	298.00

## Subbasin Hydrology

### Subbasin : A

#### Input Data

Area (ac) ..... 21.12  
 Weighted Curve Number ..... 74.38  
 Rain Gage ID ..... Rain Gage-01

#### Composite Curve Number

Soil/Surface Description	Area (acres)	Soil Group	Curve Number
Woods, Good	7.92	C	70.00
Woods, Good	13.20	D	77.00
Composite Area & Weighted CN	21.12		74.38

#### Time of Concentration

TOC Method : SCS TR-55

Sheet Flow Equation :

$$T_c = (0.007 * ((n * L_f)^{0.8}) / ((P^{0.5}) * (S_f^{0.4})))$$

Where :

T<sub>c</sub> = Time of Concentration (hr)  
 n = Manning's roughness  
 L<sub>f</sub> = Flow Length (ft)  
 P = 2 yr, 24 hr Rainfall (inches)  
 S<sub>f</sub> = Slope (ft/ft)

Shallow Concentrated Flow Equation :

V = 16.1345 \* (S<sub>f</sub><sup>0.5</sup>) (unpaved surface)  
 V = 20.3282 \* (S<sub>f</sub><sup>0.5</sup>) (paved surface)  
 V = 15.0 \* (S<sub>f</sub><sup>0.5</sup>) (grassed waterway surface)  
 V = 10.0 \* (S<sub>f</sub><sup>0.5</sup>) (nearly bare & untilled surface)  
 V = 9.0 \* (S<sub>f</sub><sup>0.5</sup>) (cultivated straight rows surface)  
 V = 7.0 \* (S<sub>f</sub><sup>0.5</sup>) (short grass pasture surface)  
 V = 5.0 \* (S<sub>f</sub><sup>0.5</sup>) (woodland surface)  
 V = 2.5 \* (S<sub>f</sub><sup>0.5</sup>) (forest w/heavy litter surface)  
 T<sub>c</sub> = (L<sub>f</sub> / V) / (3600 sec/hr)

Where:

T<sub>c</sub> = Time of Concentration (hr)  
 L<sub>f</sub> = Flow Length (ft)  
 V = Velocity (ft/sec)  
 S<sub>f</sub> = Slope (ft/ft)

Channel Flow Equation :

V = (1.49 \* (R<sup>2/3</sup>) \* (S<sub>f</sub><sup>0.5</sup>)) / n  
 R = A<sub>q</sub> / W<sub>p</sub>  
 T<sub>c</sub> = (L<sub>f</sub> / V) / (3600 sec/hr)

Where :

T<sub>c</sub> = Time of Concentration (hr)  
 L<sub>f</sub> = Flow Length (ft)  
 R = Hydraulic Radius (ft)  
 A<sub>q</sub> = Flow Area (ft<sup>2</sup>)  
 W<sub>p</sub> = Wetted Perimeter (ft)  
 V = Velocity (ft/sec)  
 S<sub>f</sub> = Slope (ft/ft)  
 n = Manning's roughness



Sheet Flow Computations	Subarea	Subarea	Subarea
	A	B	C
Manning's Roughness :	.6	0.00	0.00
Flow Length (ft) :	100	0.00	0.00
Slope (%) :	32.75	0.00	0.00
2 yr, 24 hr Rainfall (in) :	3.00	0.00	0.00
Velocity (ft/sec) :	0.17	0.00	0.00
Computed Flow Time (min) :	10.03	0.00	0.00
	Subarea	Subarea	Subarea
	A	B	C
Shallow Concentrated Flow Computations	870	1086	0.00
Flow Length (ft) :	5.65	.76	0.00
Slope (%) :	Woodland	Grassed waterway	Unpaved
Surface Type :	1.19	1.31	0.00
Velocity (ft/sec) :	12.18	13.82	0.00
Computed Flow Time (min) :	Total TOC (min) .....36.03		

**Subbasin Runoff Results**

Total Rainfall (in) .....	3.00
Total Runoff (in) .....	0.93
Peak Runoff (cfs) .....	11.40
Weighted Curve Number .....	74.38
Time of Concentration (days hh:mm:ss) .....	0 00:36:02

Subbasin : A

Rainfall Intensity Graph

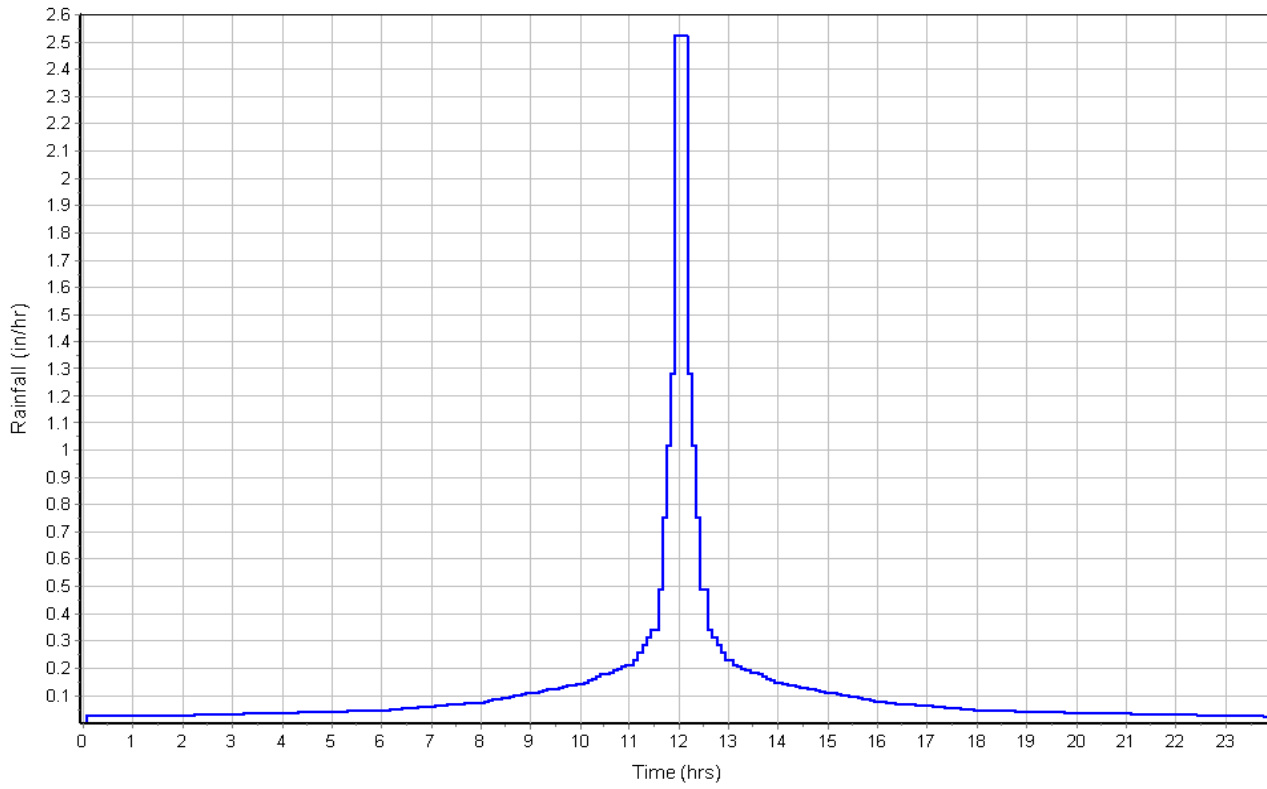

Runoff Hydrograph

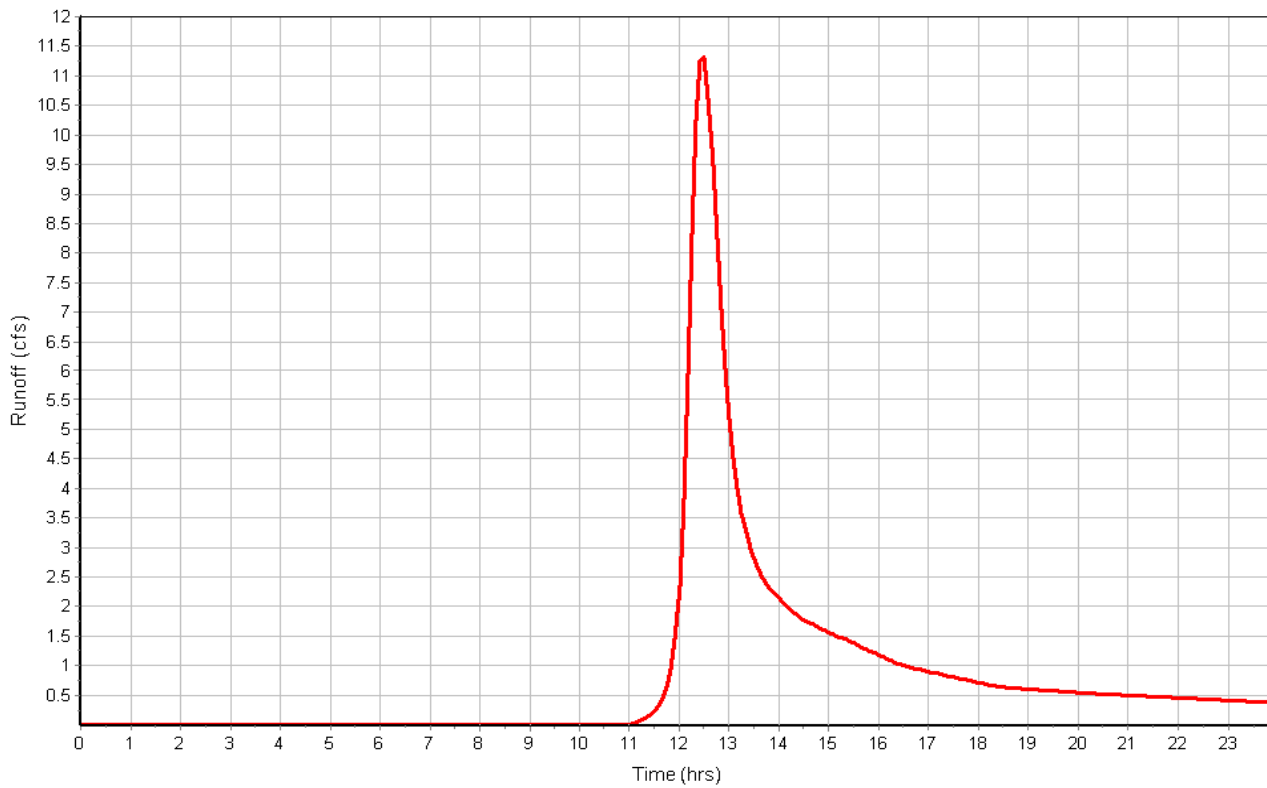

**Subbasin : B**

**Input Data**

Area (ac) ..... 5.93  
 Weighted Curve Number ..... 75.63  
 Rain Gage ID ..... Rain Gage-01

**Composite Curve Number**

Soil/Surface Description	Area (acres)	Soil Group	Curve Number
Woods, Good	1.16	C	70.00
Woods, Good	4.77	D	77.00
Composite Area & Weighted CN	5.93		75.63

**Time of Concentration**

	Subarea		
	A	B	C
Sheet Flow Computations			
Manning's Roughness :	.6	0.00	0.00
Flow Length (ft) :	100	0.00	0.00
Slope (%) :	34	0.00	0.00
2 yr, 24 hr Rainfall (in) :	3.00	0.00	0.00
Velocity (ft/sec) :	0.17	0.00	0.00
Computed Flow Time (min) :	9.88	0.00	0.00
Shallow Concentrated Flow Computations			
Flow Length (ft) :	440	0.00	0.00
Slope (%) :	10	0.00	0.00
Surface Type :	Woodland	Unpaved	Unpaved
Velocity (ft/sec) :	1.58	0.00	0.00
Computed Flow Time (min) :	4.64	0.00	0.00
Total TOC (min) .....	14.52		

**Subbasin Runoff Results**

Total Rainfall (in) ..... 3.00  
 Total Runoff (in) ..... 1.00  
 Peak Runoff (cfs) ..... 4.94  
 Weighted Curve Number ..... 75.63  
 Time of Concentration (days hh:mm:ss) ..... 0 00:14:31

**Subbasin : B**

**Rainfall Intensity Graph**

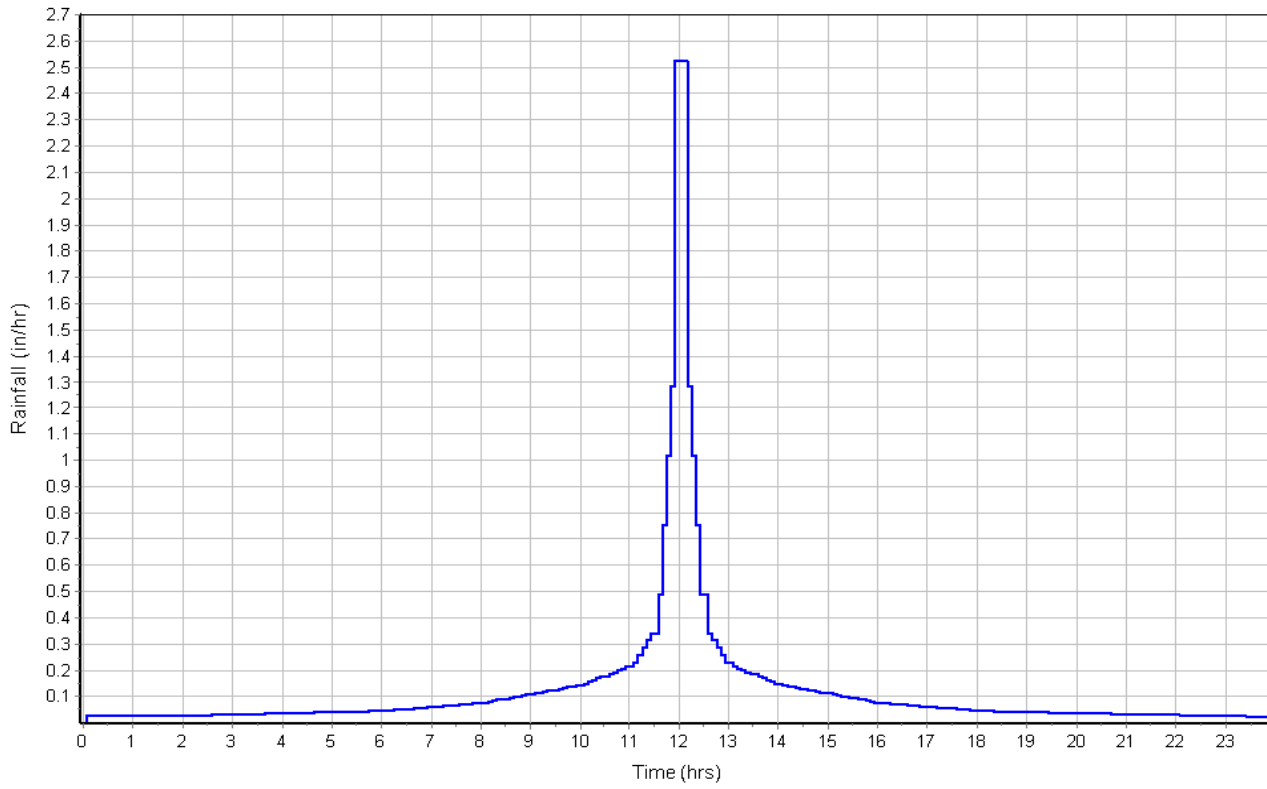

**Runoff Hydrograph**

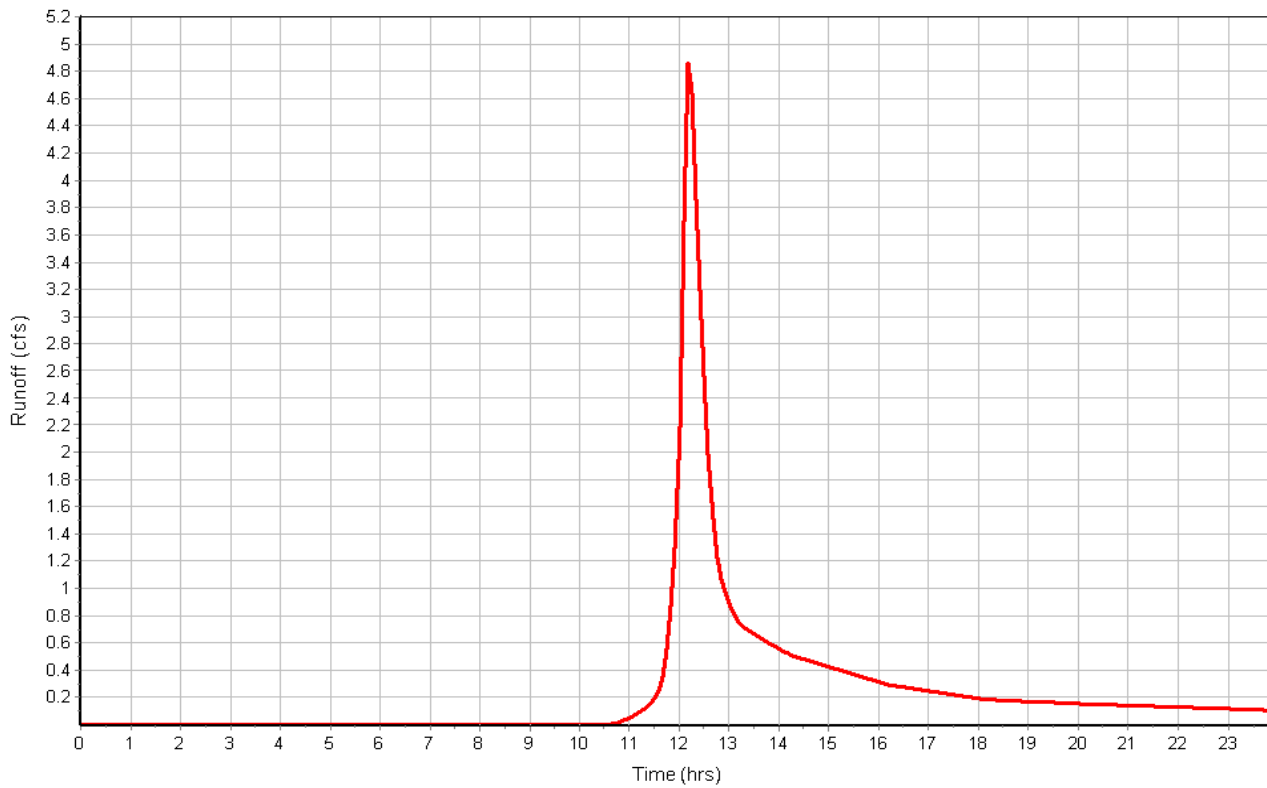

**Subbasin : C**

**Input Data**

Area (ac) ..... 17.44  
 Weighted Curve Number ..... 72.99  
 Rain Gage ID ..... Rain Gage-01

**Composite Curve Number**

Soil/Surface Description	Area (acres)	Soil Group	Curve Number
Woods, Good	10.00	C	70.00
Woods, Good	7.44	D	77.00
Composite Area & Weighted CN	17.44		72.99

**Time of Concentration**

	Subarea		
	A	B	C
Sheet Flow Computations			
Manning's Roughness :	.6	0.00	0.00
Flow Length (ft) :	100	0.00	0.00
Slope (%) :	1.61	0.00	0.00
2 yr, 24 hr Rainfall (in) :	3.00	0.00	0.00
Velocity (ft/sec) :	0.05	0.00	0.00
Computed Flow Time (min) :	33.46	0.00	0.00
Shallow Concentrated Flow Computations			
Flow Length (ft) :	2142	0.00	0.00
Slope (%) :	.47	0.00	0.00
Surface Type :	Grassed waterway	Unpaved	Unpaved
Velocity (ft/sec) :	1.03	0.00	0.00
Computed Flow Time (min) :	34.66	0.00	0.00
Total TOC (min) .....	68.12		

**Subbasin Runoff Results**

Total Rainfall (in) ..... 3.00  
 Total Runoff (in) ..... 0.86  
 Peak Runoff (cfs) ..... 6.00  
 Weighted Curve Number ..... 72.99  
 Time of Concentration (days hh:mm:ss) ..... 0 01:08:07

Subbasin : C

Rainfall Intensity Graph

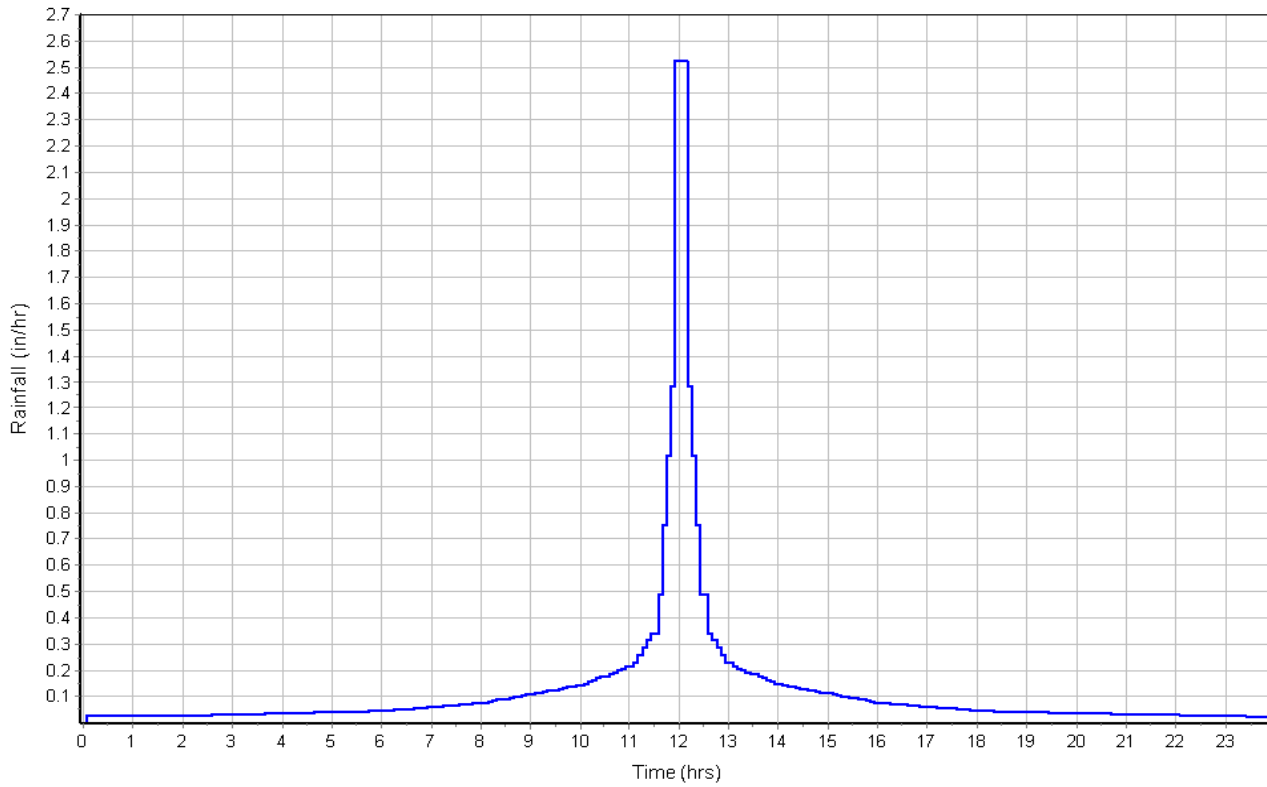

Runoff Hydrograph

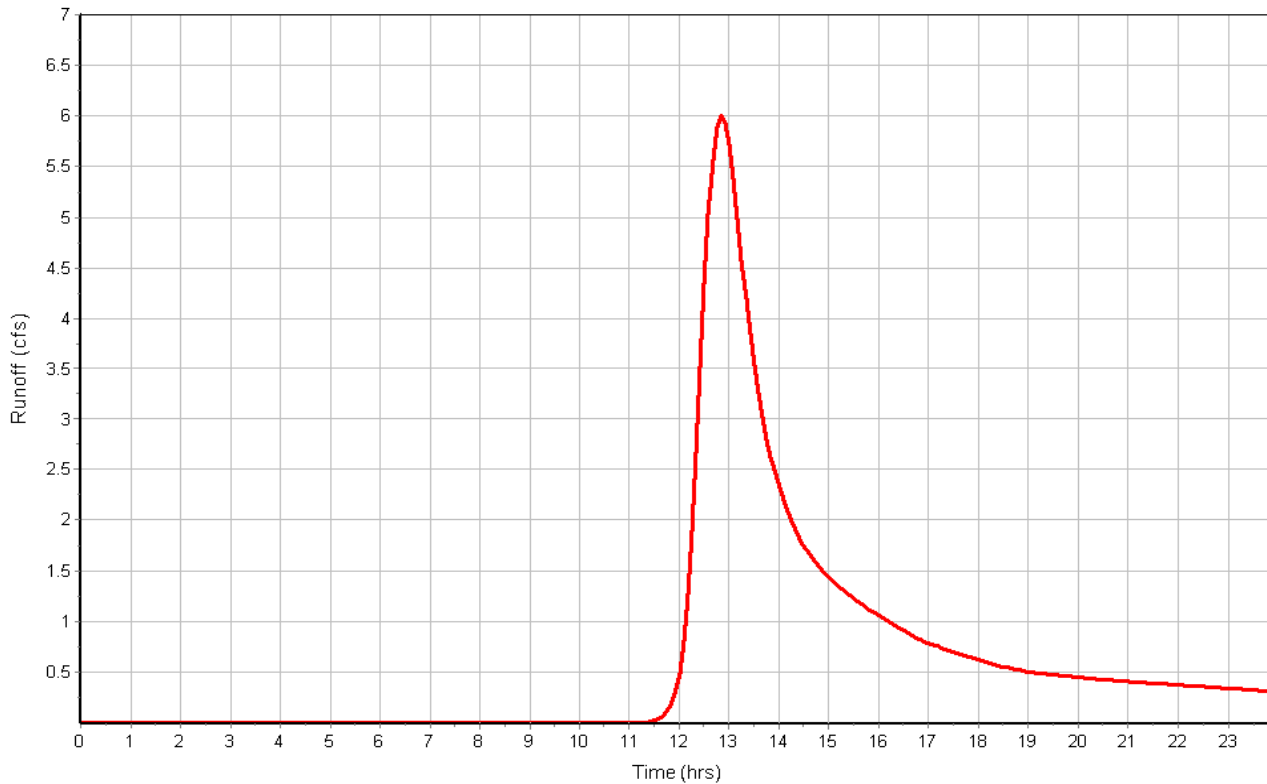

**Subbasin : D**

**Input Data**

Area (ac) ..... 0.74  
 Weighted Curve Number ..... 77.00  
 Rain Gage ID ..... Rain Gage-01

**Composite Curve Number**

Soil/Surface Description	Area (acres)	Soil Group	Curve Number
Woods, Good	0.74	D	77.00
Composite Area & Weighted CN	0.74		77.00

**Time of Concentration**

	Subarea A	Subarea B	Subarea C
<b>Sheet Flow Computations</b>			
Manning's Roughness :	.6	0.00	0.00
Flow Length (ft) :	100	0.00	0.00
Slope (%) :	23.2	0.00	0.00
2 yr, 24 hr Rainfall (in) :	3.00	0.00	0.00
Velocity (ft/sec) :	0.14	0.00	0.00
Computed Flow Time (min) :	11.51	0.00	0.00
<b>Shallow Concentrated Flow Computations</b>			
Flow Length (ft) :	33	0.00	0.00
Slope (%) :	14.75	0.00	0.00
Surface Type :	Woodland	Unpaved	Unpaved
Velocity (ft/sec) :	1.92	0.00	0.00
Computed Flow Time (min) :	0.29	0.00	0.00
Total TOC (min) .....	11.79		

**Subbasin Runoff Results**

Total Rainfall (in) ..... 3.00  
 Total Runoff (in) ..... 1.07  
 Peak Runoff (cfs) ..... 0.72  
 Weighted Curve Number ..... 77.00  
 Time of Concentration (days hh:mm:ss) ..... 0 00:11:47

Subbasin : D

Rainfall Intensity Graph

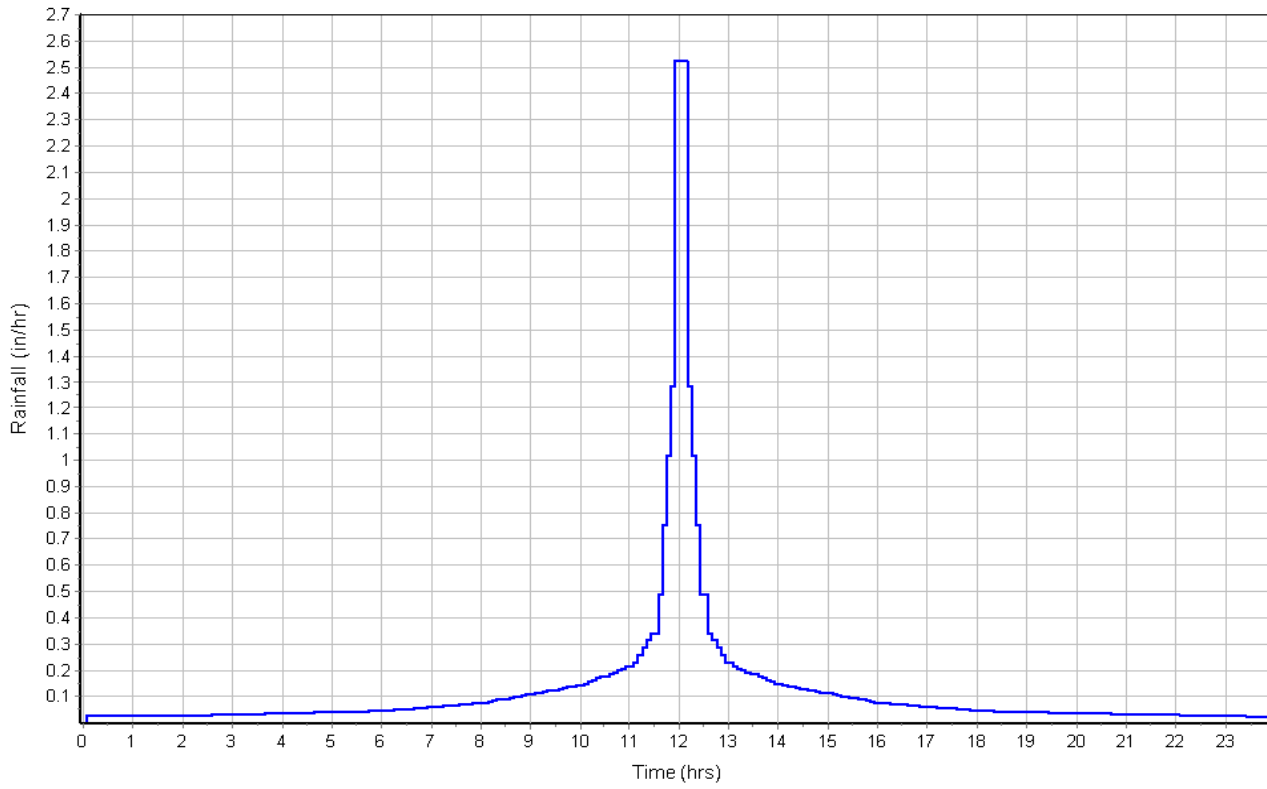

Runoff Hydrograph

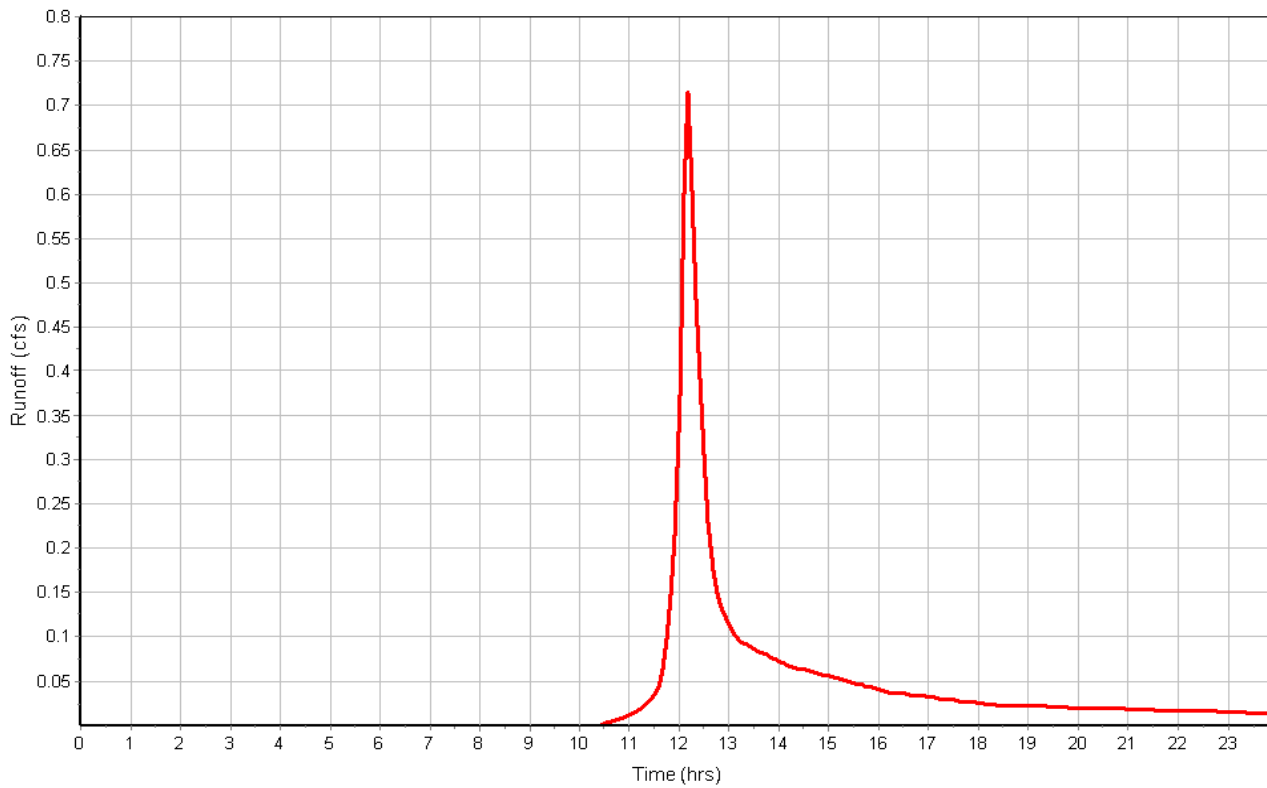



**Subbasin : E**

**Input Data**

Area (ac) ..... 3.72  
 Weighted Curve Number ..... 77.00  
 Rain Gage ID ..... Rain Gage-01

**Composite Curve Number**

Soil/Surface Description	Area (acres)	Soil Group	Curve Number
Woods, Good	3.72	D	77.00
Composite Area & Weighted CN	3.72		77.00

**Time of Concentration**

Sheet Flow Computations	Subarea	Subarea	Subarea
	A	B	C
Manning's Roughness :	.6	0.00	0.00
Flow Length (ft) :	100	0.00	0.00
Slope (%) :	14	0.00	0.00
2 yr, 24 hr Rainfall (in) :	3.00	0.00	0.00
Velocity (ft/sec) :	0.12	0.00	0.00
Computed Flow Time (min) :	14.09	0.00	0.00

Shallow Concentrated Flow Computations	Subarea	Subarea	Subarea
	A	B	C
Flow Length (ft) :	375	0.00	0.00
Slope (%) :	20.25	0.00	0.00
Surface Type :	Woodland	Unpaved	Unpaved
Velocity (ft/sec) :	2.25	0.00	0.00
Computed Flow Time (min) :	2.78	0.00	0.00
Total TOC (min) .....	16.86		

**Subbasin Runoff Results**

Total Rainfall (in) ..... 3.00  
 Total Runoff (in) ..... 1.07  
 Peak Runoff (cfs) ..... 3.22  
 Weighted Curve Number ..... 77.00  
 Time of Concentration (days hh:mm:ss) ..... 0 00:16:52

Subbasin : E

Rainfall Intensity Graph

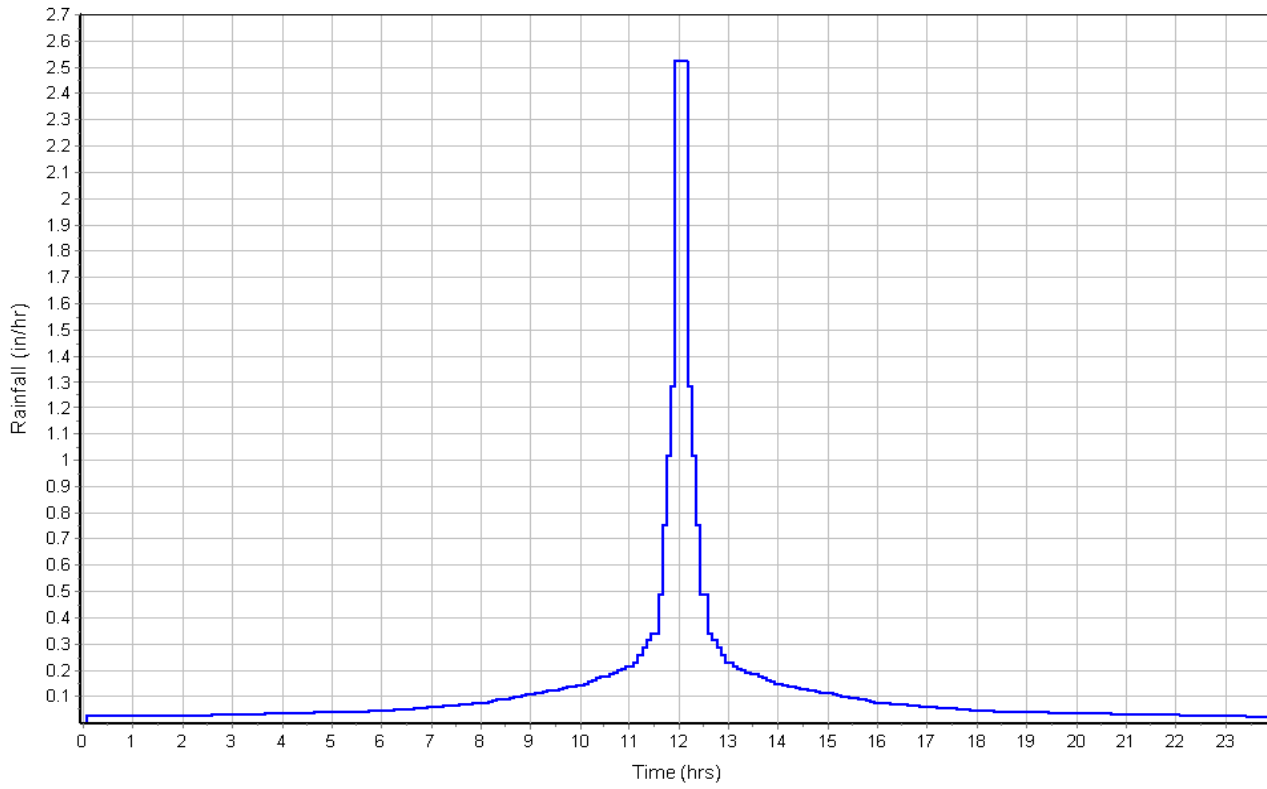

Runoff Hydrograph

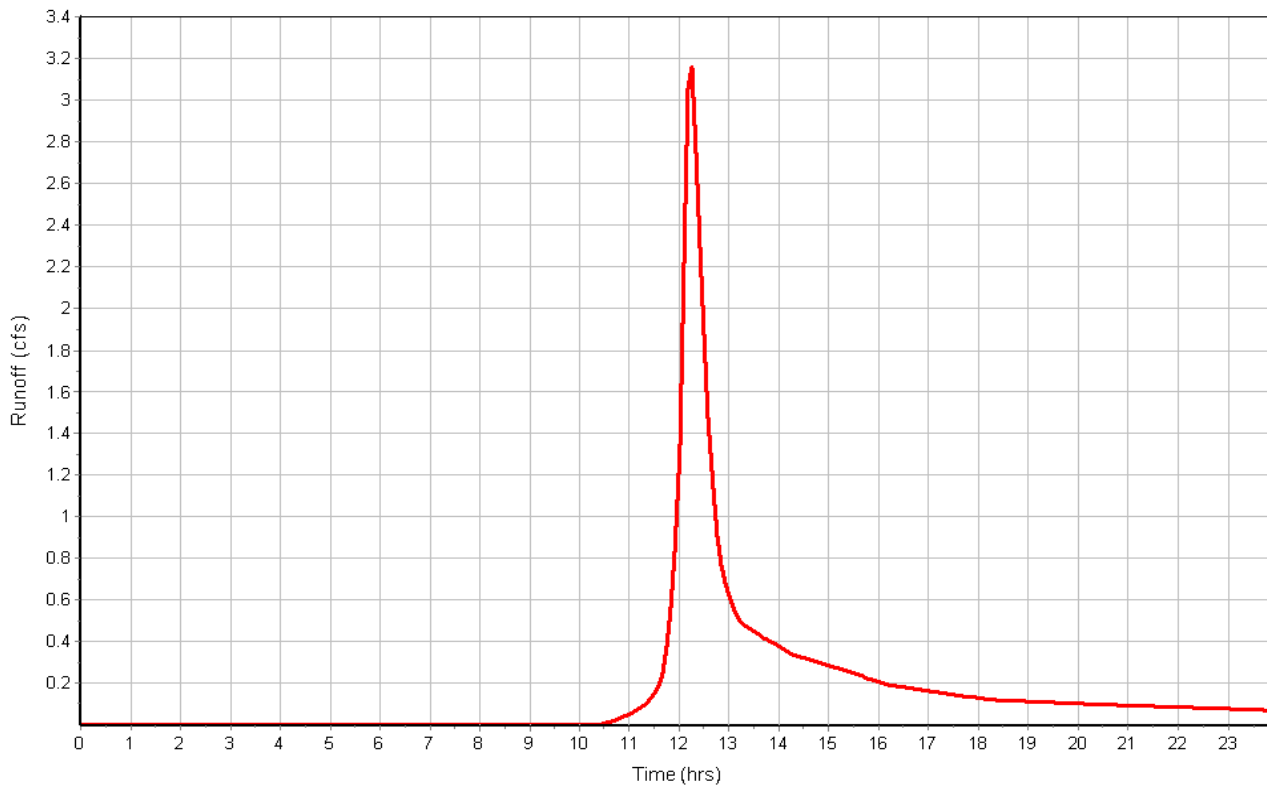

## Project Description

File Name ..... Existing Conditions.SPF

## Project Options

Flow Units ..... CFS  
 Elevation Type ..... Elevation  
 Hydrology Method ..... SCS TR-55  
 Time of Concentration (TOC) Method ..... SCS TR-55  
 Link Routing Method ..... Kinematic Wave  
 Enable Overflow Ponding at Nodes ..... YES  
 Skip Steady State Analysis Time Periods ..... NO

## Analysis Options

Start Analysis On ..... Jul 13, 2017 00:00:00  
 End Analysis On ..... Jul 14, 2017 00:00:00  
 Start Reporting On ..... Jul 13, 2017 00:00:00  
 Antecedent Dry Days ..... 0 days  
 Runoff (Dry Weather) Time Step ..... 0 01:00:00 days hh:mm:ss  
 Runoff (Wet Weather) Time Step ..... 0 00:05:00 days hh:mm:ss  
 Reporting Time Step ..... 0 00:05:00 days hh:mm:ss  
 Routing Time Step ..... 30 seconds

## Number of Elements

	Qty
Rain Gages .....	1
Subbasins.....	5
Nodes.....	5
<i>Junctions</i> .....	0
<i>Outfalls</i> .....	5
<i>Flow Diversions</i> .....	0
<i>Inlets</i> .....	0
<i>Storage Nodes</i> .....	0
Links.....	0
<i>Channels</i> .....	0
<i>Pipes</i> .....	0
<i>Pumps</i> .....	0
<i>Orifices</i> .....	0
<i>Weirs</i> .....	0
<i>Outlets</i> .....	0
Pollutants .....	0
Land Uses .....	0

## Rainfall Details

SN	Rain Gage ID	Data Source	Data Source ID	Rainfall Type	Rain Units	State	County	Return Period (years)	Rainfall Depth (inches)	Rainfall Distribution
1	Rain Gage-01	Time Series	TS-10	Cumulative	inches	Maine	Androscoggin	10	4.60	SCS Type III 24-hr

## Subbasin Summary

Subbasin ID	Area (ac)	Weighted Curve Number	Total Rainfall (in)	Total Runoff (in)	Total Runoff Volume (ac-in)	Peak Runoff (cfs)	Time of Concentration (days hh:mm:ss)
A	21.12	74.38	4.60	2.08	43.93	27.00	0 00:36:01
B	5.93	75.63	4.60	2.18	12.93	11.30	0 00:14:31
C	17.44	72.99	4.60	1.97	34.37	14.87	0 01:08:07
D	0.74	77.00	4.60	2.29	1.70	1.58	0 00:11:47
E	3.72	77.00	4.60	2.29	8.53	7.13	0 00:16:51

## Node Summary

Element ID	Element Type	Invert Elevation
---------------	-----------------	---------------------

(ft)		
OUT-A	Outfall	298.00
OUT-B	Outfall	310.00
OUT-C	Outfall	298.00
OUT-D	Outfall	338.00
OUT-E	Outfall	298.00

## Subbasin Hydrology

### Subbasin : A

#### Input Data

Area (ac) ..... 21.12  
 Weighted Curve Number ..... 74.38  
 Rain Gage ID ..... Rain Gage-01

#### Composite Curve Number

Soil/Surface Description	Area (acres)	Soil Group	Curve Number
Woods, Good	7.92	C	70.00
Woods, Good	13.20	D	77.00
Composite Area & Weighted CN	21.12		74.38

#### Time of Concentration

TOC Method : SCS TR-55

Sheet Flow Equation :

$$T_c = (0.007 * ((n * L_f)^{0.8}) / ((P^{0.5}) * (S_f^{0.4})))$$

Where :

T<sub>c</sub> = Time of Concentration (hr)  
 n = Manning's roughness  
 L<sub>f</sub> = Flow Length (ft)  
 P = 2 yr, 24 hr Rainfall (inches)  
 S<sub>f</sub> = Slope (ft/ft)

Shallow Concentrated Flow Equation :

V = 16.1345 \* (S<sub>f</sub><sup>0.5</sup>) (unpaved surface)  
 V = 20.3282 \* (S<sub>f</sub><sup>0.5</sup>) (paved surface)  
 V = 15.0 \* (S<sub>f</sub><sup>0.5</sup>) (grassed waterway surface)  
 V = 10.0 \* (S<sub>f</sub><sup>0.5</sup>) (nearly bare & untilled surface)  
 V = 9.0 \* (S<sub>f</sub><sup>0.5</sup>) (cultivated straight rows surface)  
 V = 7.0 \* (S<sub>f</sub><sup>0.5</sup>) (short grass pasture surface)  
 V = 5.0 \* (S<sub>f</sub><sup>0.5</sup>) (woodland surface)  
 V = 2.5 \* (S<sub>f</sub><sup>0.5</sup>) (forest w/heavy litter surface)  
 T<sub>c</sub> = (L<sub>f</sub> / V) / (3600 sec/hr)

Where:

T<sub>c</sub> = Time of Concentration (hr)  
 L<sub>f</sub> = Flow Length (ft)  
 V = Velocity (ft/sec)  
 S<sub>f</sub> = Slope (ft/ft)

Channel Flow Equation :

V = (1.49 \* (R<sup>2/3</sup>) \* (S<sub>f</sub><sup>0.5</sup>)) / n  
 R = A<sub>q</sub> / W<sub>p</sub>  
 T<sub>c</sub> = (L<sub>f</sub> / V) / (3600 sec/hr)

Where :

T<sub>c</sub> = Time of Concentration (hr)  
 L<sub>f</sub> = Flow Length (ft)  
 R = Hydraulic Radius (ft)  
 A<sub>q</sub> = Flow Area (ft<sup>2</sup>)  
 W<sub>p</sub> = Wetted Perimeter (ft)  
 V = Velocity (ft/sec)  
 S<sub>f</sub> = Slope (ft/ft)  
 n = Manning's roughness

Sheet Flow Computations	Subarea	Subarea	Subarea
	A	B	C
Manning's Roughness :	.6	0.00	0.00
Flow Length (ft) :	100	0.00	0.00
Slope (%) :	32.75	0.00	0.00
2 yr, 24 hr Rainfall (in) :	3.00	0.00	0.00
Velocity (ft/sec) :	0.17	0.00	0.00
Computed Flow Time (min) :	10.03	0.00	0.00
	Subarea	Subarea	Subarea
	A	B	C
Shallow Concentrated Flow Computations	870	1086	0.00
Flow Length (ft) :	5.65	.76	0.00
Slope (%) :	Woodland	Grassed waterway	Unpaved
Surface Type :	1.19	1.31	0.00
Velocity (ft/sec) :	12.18	13.82	0.00
Computed Flow Time (min) :	Total TOC (min) .....36.03		

**Subbasin Runoff Results**

Total Rainfall (in) .....	4.60
Total Runoff (in) .....	2.08
Peak Runoff (cfs) .....	27.00
Weighted Curve Number .....	74.38
Time of Concentration (days hh:mm:ss) .....	0 00:36:02

Subbasin : A

Rainfall Intensity Graph

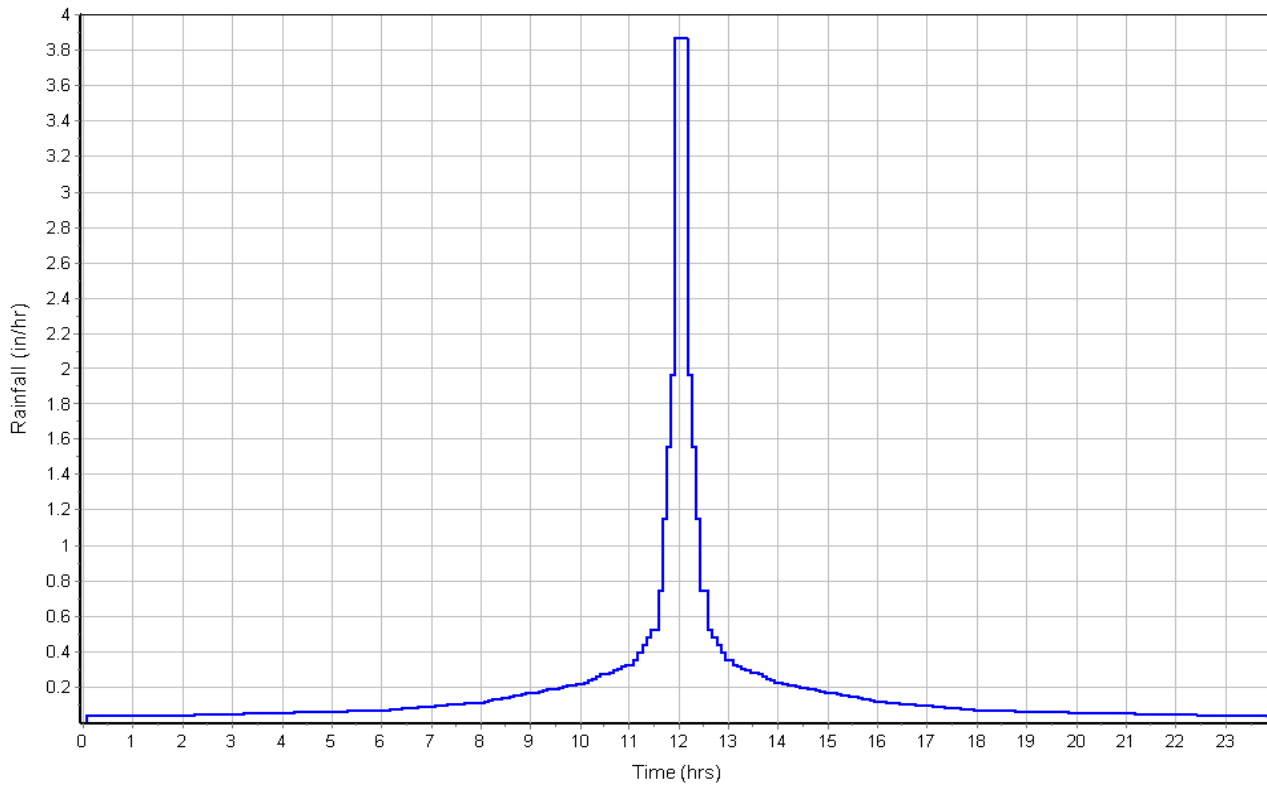

Runoff Hydrograph

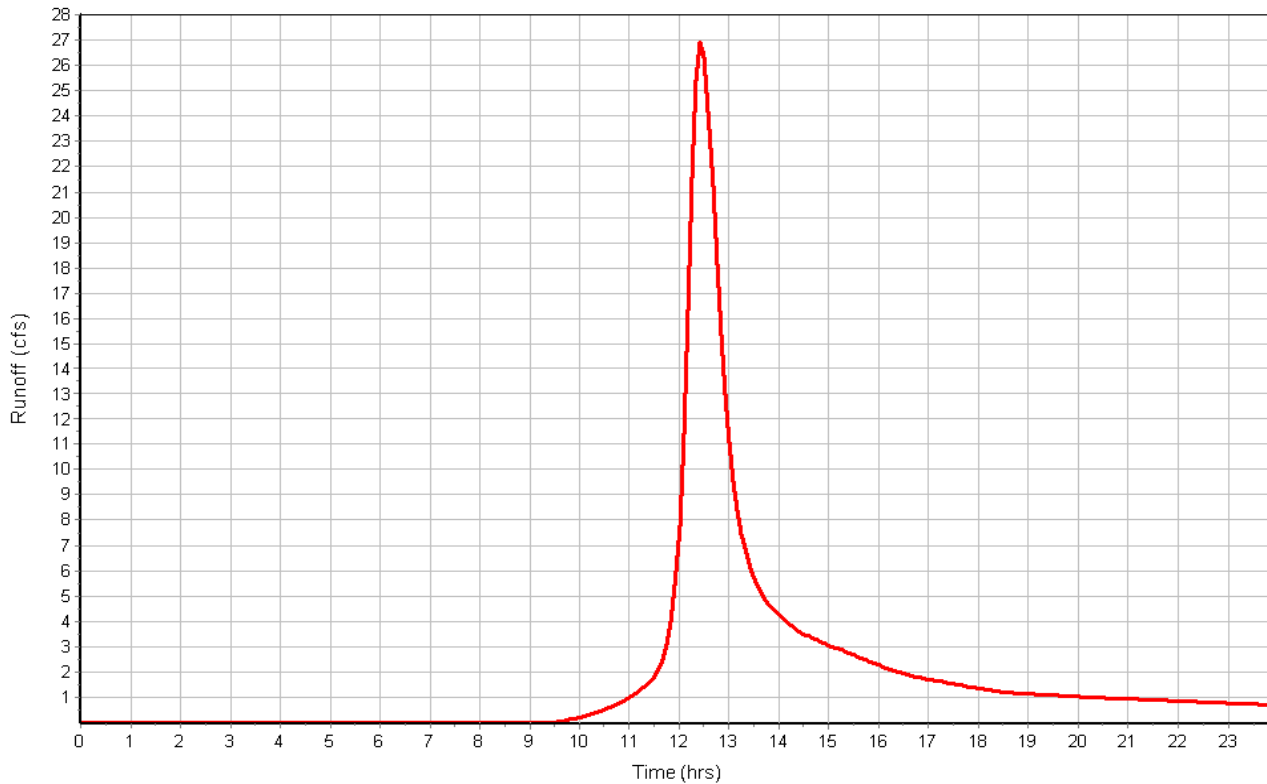



**Subbasin : B**

**Input Data**

Area (ac) ..... 5.93  
 Weighted Curve Number ..... 75.63  
 Rain Gage ID ..... Rain Gage-01

**Composite Curve Number**

Soil/Surface Description	Area (acres)	Soil Group	Curve Number
Woods, Good	1.16	C	70.00
Woods, Good	4.77	D	77.00
Composite Area & Weighted CN	5.93		75.63

**Time of Concentration**

	Subarea		
	A	B	C
Sheet Flow Computations			
Manning's Roughness :	.6	0.00	0.00
Flow Length (ft) :	100	0.00	0.00
Slope (%) :	34	0.00	0.00
2 yr, 24 hr Rainfall (in) :	3.00	0.00	0.00
Velocity (ft/sec) :	0.17	0.00	0.00
Computed Flow Time (min) :	9.88	0.00	0.00
Shallow Concentrated Flow Computations			
Flow Length (ft) :	440	0.00	0.00
Slope (%) :	10	0.00	0.00
Surface Type :	Woodland	Unpaved	Unpaved
Velocity (ft/sec) :	1.58	0.00	0.00
Computed Flow Time (min) :	4.64	0.00	0.00
Total TOC (min) .....	14.52		

**Subbasin Runoff Results**

Total Rainfall (in) ..... 4.60  
 Total Runoff (in) ..... 2.18  
 Peak Runoff (cfs) ..... 11.30  
 Weighted Curve Number ..... 75.63  
 Time of Concentration (days hh:mm:ss) ..... 0 00:14:31

**Subbasin : B**

**Rainfall Intensity Graph**

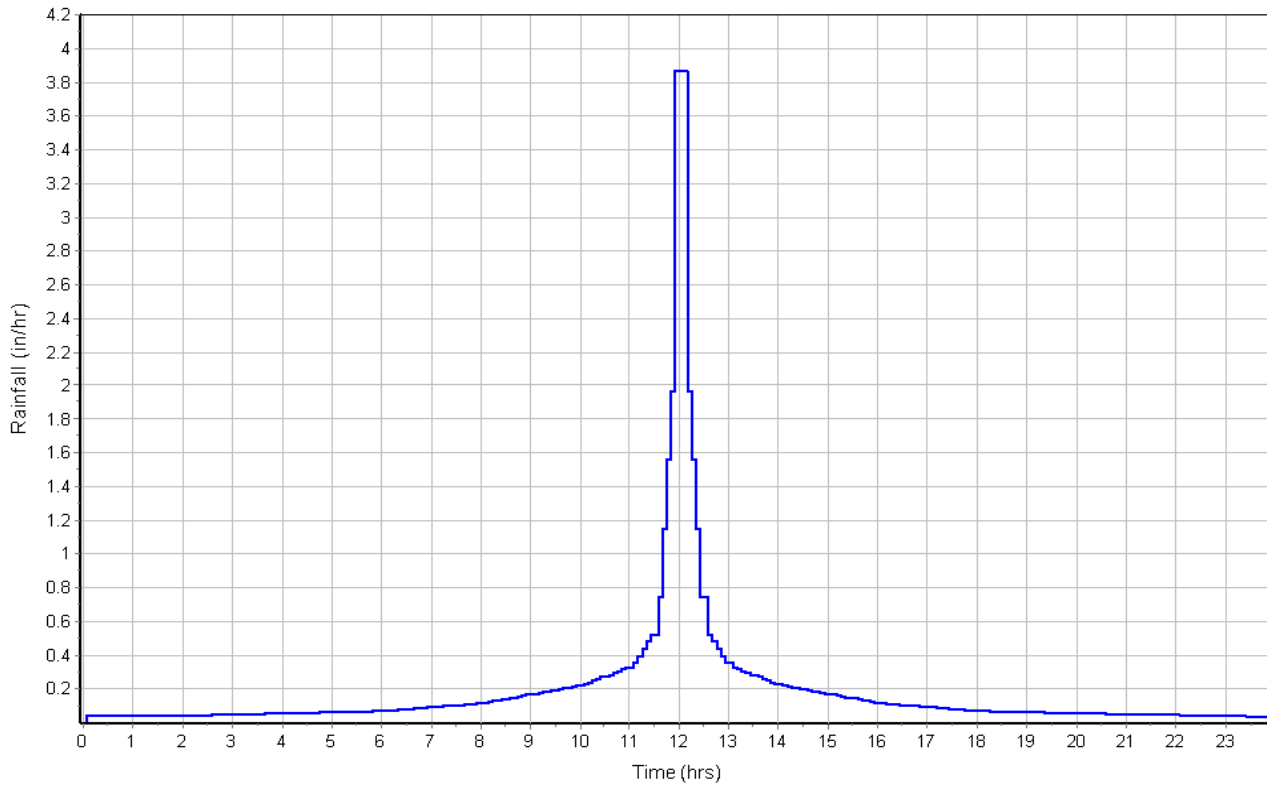

**Runoff Hydrograph**

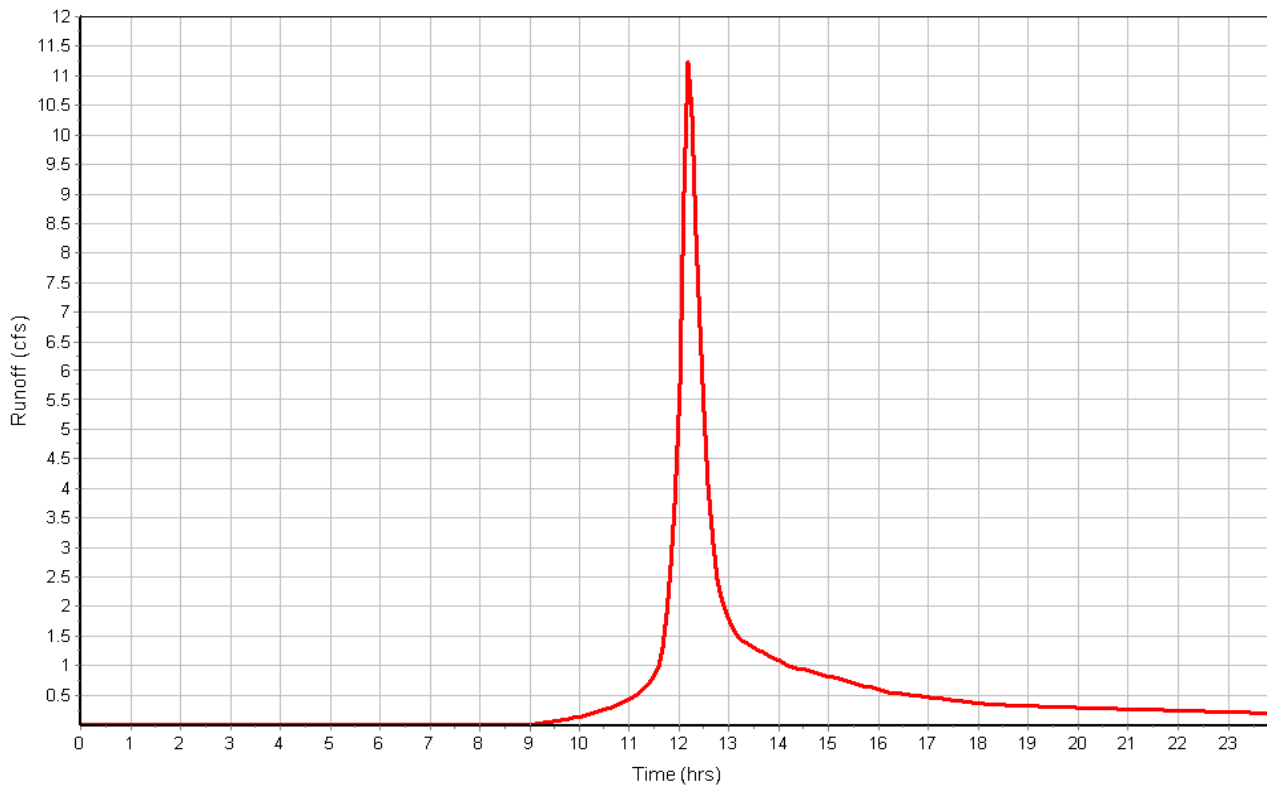

**Subbasin : C**

**Input Data**

Area (ac) ..... 17.44  
 Weighted Curve Number ..... 72.99  
 Rain Gage ID ..... Rain Gage-01

**Composite Curve Number**

Soil/Surface Description	Area (acres)	Soil Group	Curve Number
Woods, Good	10.00	C	70.00
Woods, Good	7.44	D	77.00
Composite Area & Weighted CN	17.44		72.99

**Time of Concentration**

	Subarea A	Subarea B	Subarea C
Sheet Flow Computations			
Manning's Roughness :	.6	0.00	0.00
Flow Length (ft) :	100	0.00	0.00
Slope (%) :	1.61	0.00	0.00
2 yr, 24 hr Rainfall (in) :	3.00	0.00	0.00
Velocity (ft/sec) :	0.05	0.00	0.00
Computed Flow Time (min) :	33.46	0.00	0.00
Shallow Concentrated Flow Computations			
Flow Length (ft) :	2142	0.00	0.00
Slope (%) :	.47	0.00	0.00
Surface Type :	Grassed waterway	Unpaved	Unpaved
Velocity (ft/sec) :	1.03	0.00	0.00
Computed Flow Time (min) :	34.66	0.00	0.00
Total TOC (min) .....	68.12		

**Subbasin Runoff Results**

Total Rainfall (in) ..... 4.60  
 Total Runoff (in) ..... 1.97  
 Peak Runoff (cfs) ..... 14.87  
 Weighted Curve Number ..... 72.99  
 Time of Concentration (days hh:mm:ss) ..... 0 01:08:07

Subbasin : C

Rainfall Intensity Graph

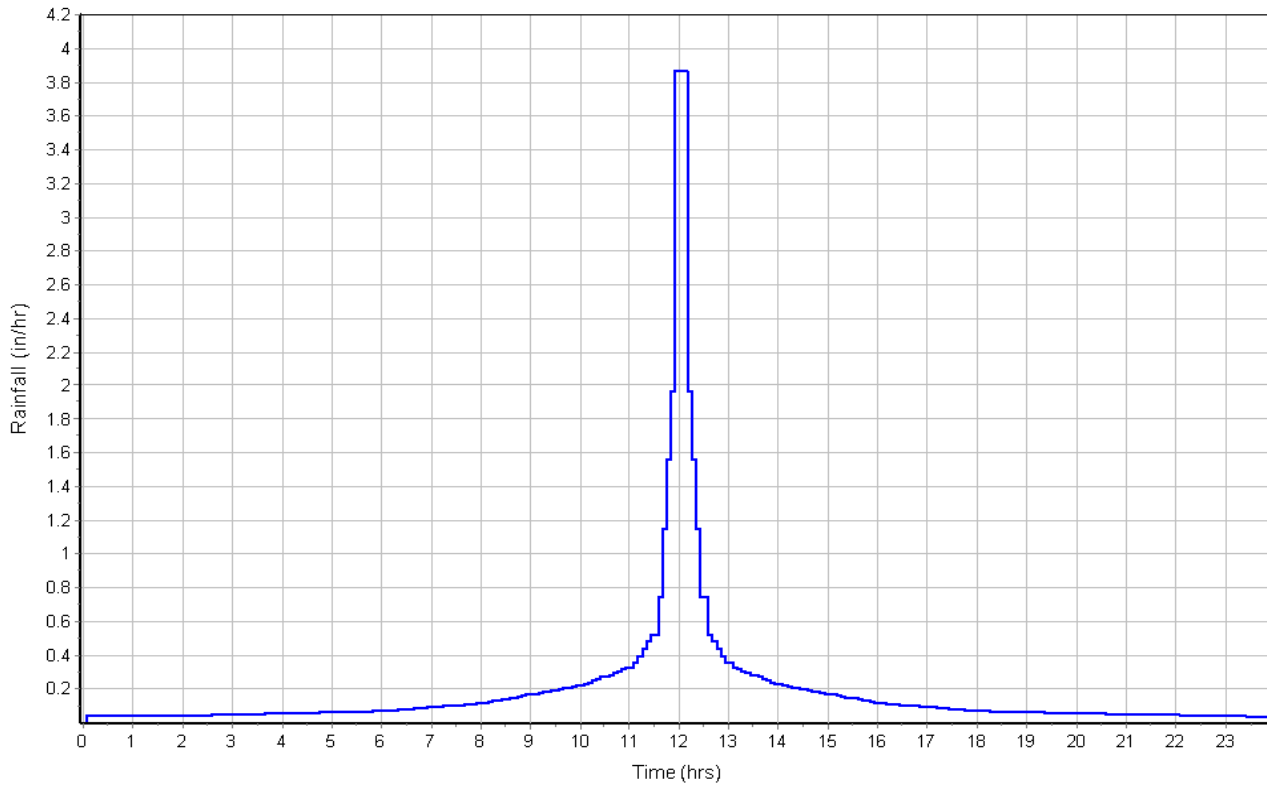

Runoff Hydrograph

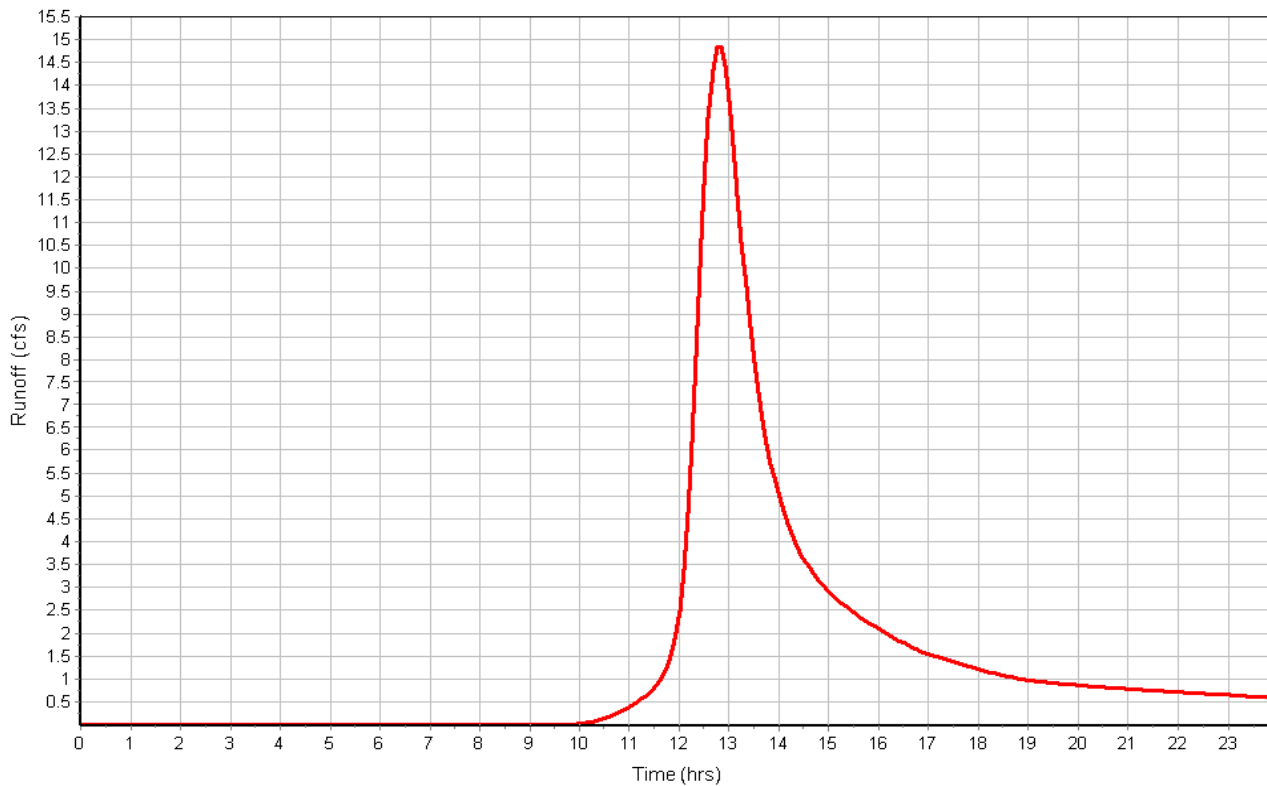

**Subbasin : D**

**Input Data**

Area (ac) ..... 0.74  
 Weighted Curve Number ..... 77.00  
 Rain Gage ID ..... Rain Gage-01

**Composite Curve Number**

Soil/Surface Description	Area (acres)	Soil Group	Curve Number
Woods, Good	0.74	D	77.00
Composite Area & Weighted CN	0.74		77.00

**Time of Concentration**

	Subarea A	Subarea B	Subarea C
Sheet Flow Computations			
Manning's Roughness :	.6	0.00	0.00
Flow Length (ft) :	100	0.00	0.00
Slope (%) :	23.2	0.00	0.00
2 yr, 24 hr Rainfall (in) :	3.00	0.00	0.00
Velocity (ft/sec) :	0.14	0.00	0.00
Computed Flow Time (min) :	11.51	0.00	0.00

	Subarea A	Subarea B	Subarea C
Shallow Concentrated Flow Computations			
Flow Length (ft) :	33	0.00	0.00
Slope (%) :	14.75	0.00	0.00
Surface Type :	Woodland	Unpaved	Unpaved
Velocity (ft/sec) :	1.92	0.00	0.00
Computed Flow Time (min) :	0.29	0.00	0.00
Total TOC (min) .....11.79			

**Subbasin Runoff Results**

Total Rainfall (in) ..... 4.60  
 Total Runoff (in) ..... 2.29  
 Peak Runoff (cfs) ..... 1.58  
 Weighted Curve Number ..... 77.00  
 Time of Concentration (days hh:mm:ss) ..... 0 00:11:47

Subbasin : D

Rainfall Intensity Graph

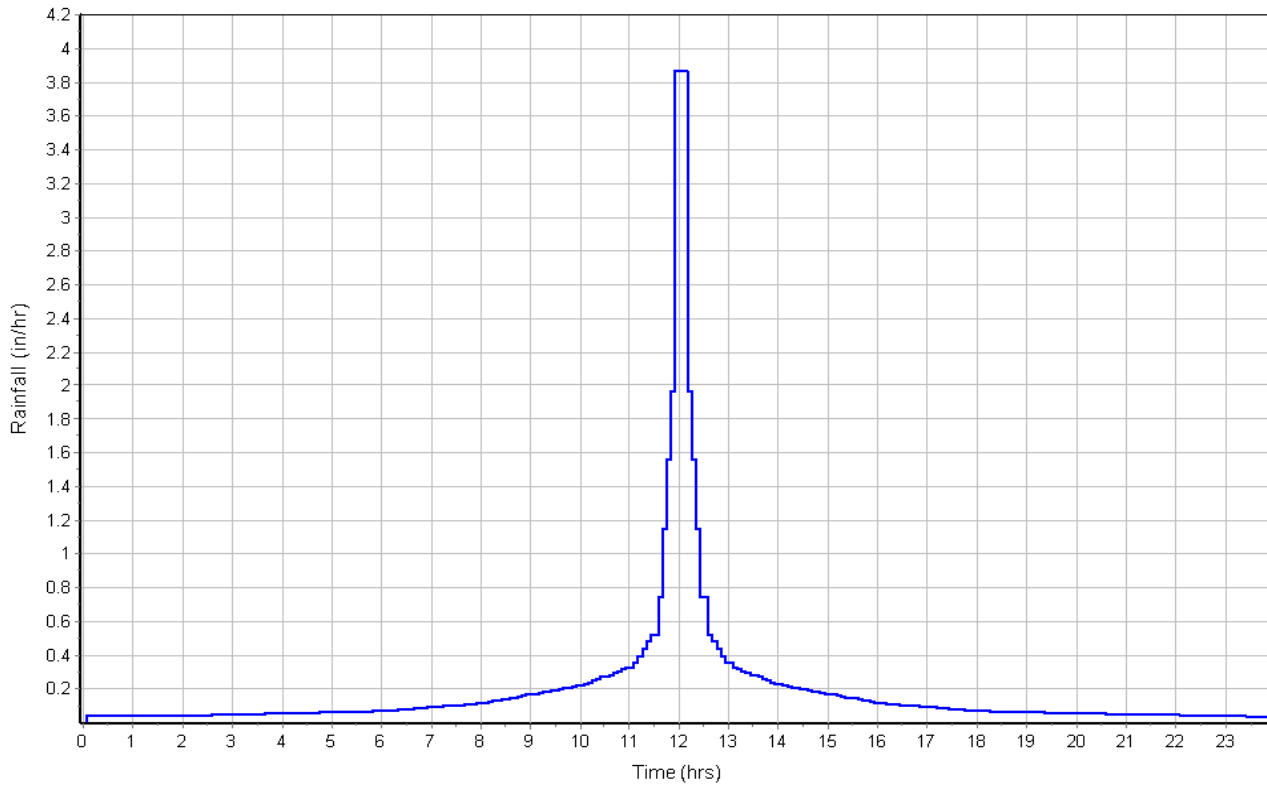

Runoff Hydrograph

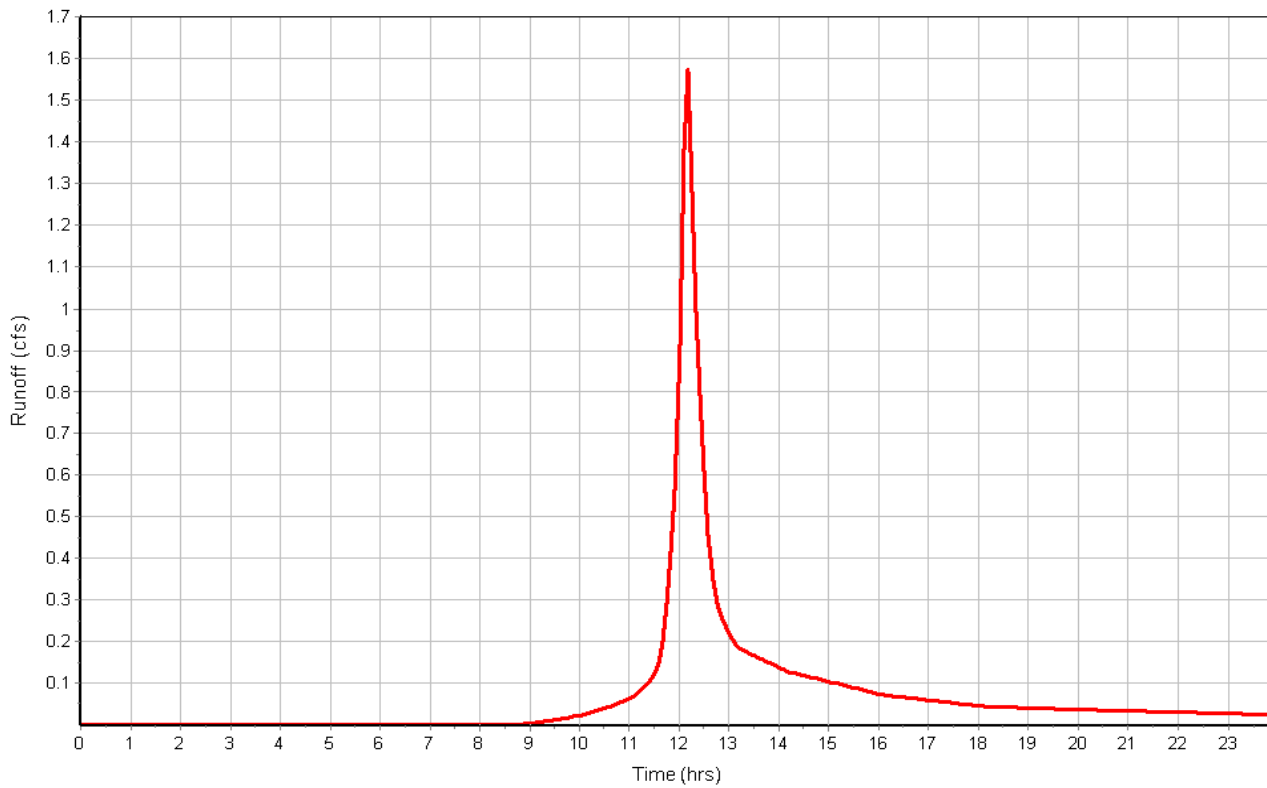

**Subbasin : E**

**Input Data**

Area (ac) ..... 3.72  
 Weighted Curve Number ..... 77.00  
 Rain Gage ID ..... Rain Gage-01

**Composite Curve Number**

Soil/Surface Description	Area (acres)	Soil Group	Curve Number
Woods, Good	3.72	D	77.00
Composite Area & Weighted CN	3.72		77.00

**Time of Concentration**

	Subarea A	Subarea B	Subarea C
<b>Sheet Flow Computations</b>			
Manning's Roughness :	.6	0.00	0.00
Flow Length (ft) :	100	0.00	0.00
Slope (%) :	14	0.00	0.00
2 yr, 24 hr Rainfall (in) :	3.00	0.00	0.00
Velocity (ft/sec) :	0.12	0.00	0.00
Computed Flow Time (min) :	14.09	0.00	0.00
<b>Shallow Concentrated Flow Computations</b>			
Flow Length (ft) :	375	0.00	0.00
Slope (%) :	20.25	0.00	0.00
Surface Type :	Woodland	Unpaved	Unpaved
Velocity (ft/sec) :	2.25	0.00	0.00
Computed Flow Time (min) :	2.78	0.00	0.00
Total TOC (min) .....	16.86		

**Subbasin Runoff Results**

Total Rainfall (in) ..... 4.60  
 Total Runoff (in) ..... 2.29  
 Peak Runoff (cfs) ..... 7.13  
 Weighted Curve Number ..... 77.00  
 Time of Concentration (days hh:mm:ss) ..... 0 00:16:52

Subbasin : E

Rainfall Intensity Graph

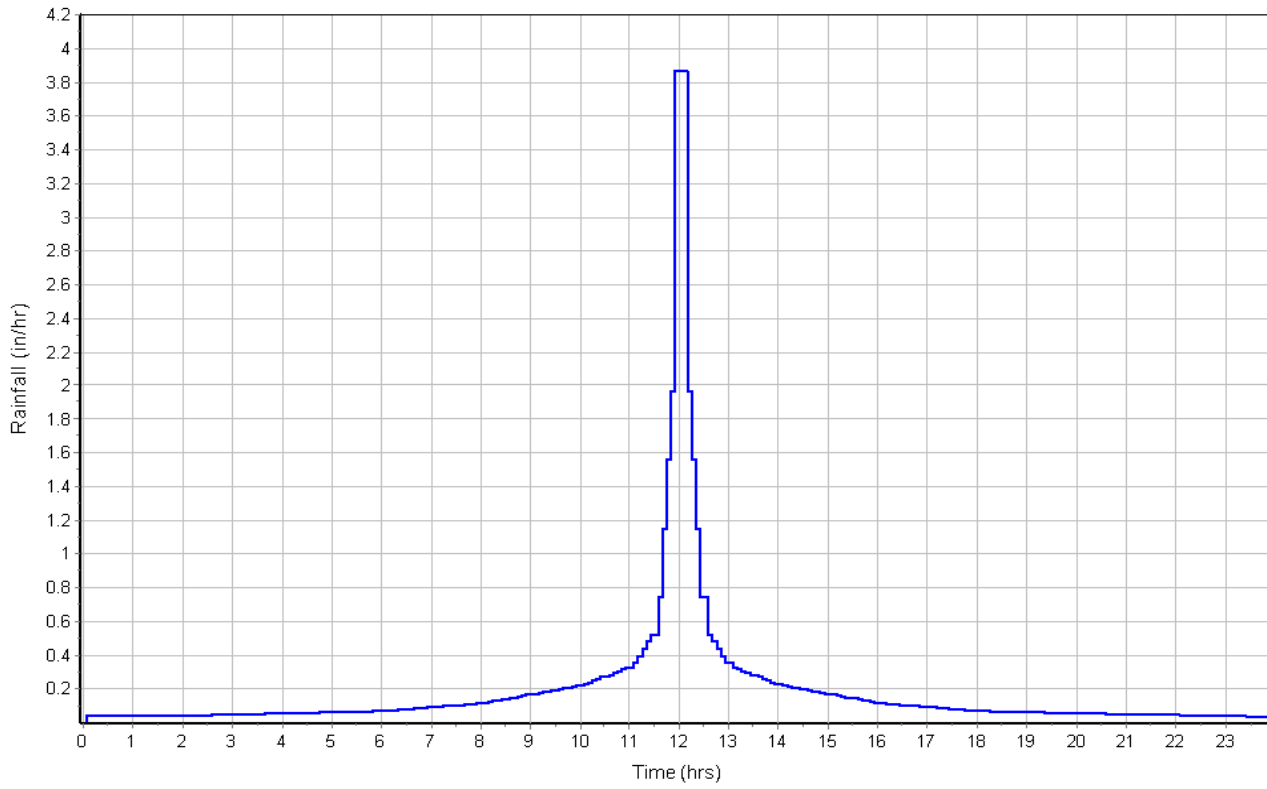

Runoff Hydrograph

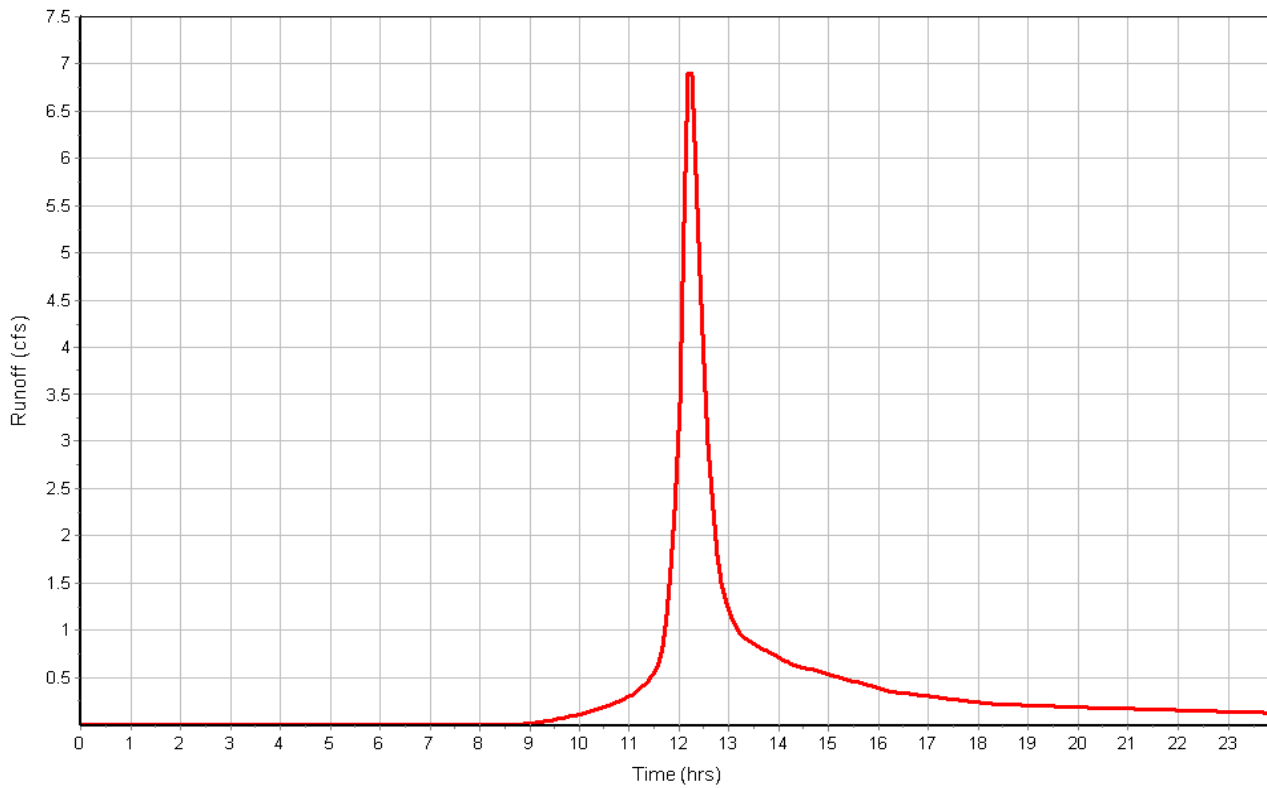



## Project Description

File Name ..... Existing Conditions.SPF

## Project Options

Flow Units ..... CFS  
 Elevation Type ..... Elevation  
 Hydrology Method ..... SCS TR-55  
 Time of Concentration (TOC) Method ..... SCS TR-55  
 Link Routing Method ..... Kinematic Wave  
 Enable Overflow Ponding at Nodes ..... YES  
 Skip Steady State Analysis Time Periods ..... NO

## Analysis Options

Start Analysis On ..... Jul 13, 2017 00:00:00  
 End Analysis On ..... Jul 14, 2017 00:00:00  
 Start Reporting On ..... Jul 13, 2017 00:00:00  
 Antecedent Dry Days ..... 0 days  
 Runoff (Dry Weather) Time Step ..... 0 01:00:00 days hh:mm:ss  
 Runoff (Wet Weather) Time Step ..... 0 00:05:00 days hh:mm:ss  
 Reporting Time Step ..... 0 00:05:00 days hh:mm:ss  
 Routing Time Step ..... 30 seconds

## Number of Elements

	Qty
Rain Gages .....	1
Subbasins.....	5
Nodes.....	5
<i>Junctions</i> .....	0
<i>Outfalls</i> .....	5
<i>Flow Diversions</i> .....	0
<i>Inlets</i> .....	0
<i>Storage Nodes</i> .....	0
Links.....	0
<i>Channels</i> .....	0
<i>Pipes</i> .....	0
<i>Pumps</i> .....	0
<i>Orifices</i> .....	0
<i>Weirs</i> .....	0
<i>Outlets</i> .....	0
Pollutants .....	0
Land Uses .....	0

## Rainfall Details

SN	Rain Gage ID	Data Source	Data Source ID	Rainfall Type	Rain Units	State	County	Return Period (years)	Rainfall Depth (inches)	Rainfall Distribution
1	Rain Gage-01	Time Series	TS-25	Cumulative	inches	Maine	Androscoggin	25	5.40	SCS Type III 24-hr

## Subbasin Summary

Subbasin ID	Area (ac)	Weighted Curve Number	Total Rainfall (in)	Total Runoff (in)	Total Runoff Volume (ac-in)	Peak Runoff (cfs)	Time of Concentration (days hh:mm:ss)
A	21.12	74.38	5.40	2.72	57.47	35.56	0 00:36:01
B	5.93	75.63	5.40	2.84	16.81	14.75	0 00:14:31
C	17.44	72.99	5.40	2.60	45.29	19.86	0 01:08:07
D	0.74	77.00	5.40	2.96	2.19	2.04	0 00:11:47
E	3.72	77.00	5.40	2.96	11.01	9.23	0 00:16:51

## Node Summary

Element ID	Element Type	Invert Elevation
---------------	-----------------	---------------------

(ft)		
OUT-A	Outfall	298.00
OUT-B	Outfall	310.00
OUT-C	Outfall	298.00
OUT-D	Outfall	338.00
OUT-E	Outfall	298.00

## Subbasin Hydrology

### Subbasin : A

#### Input Data

Area (ac) ..... 21.12  
 Weighted Curve Number ..... 74.38  
 Rain Gage ID ..... Rain Gage-01

#### Composite Curve Number

Soil/Surface Description	Area (acres)	Soil Group	Curve Number
Woods, Good	7.92	C	70.00
Woods, Good	13.20	D	77.00
Composite Area & Weighted CN	21.12		74.38

#### Time of Concentration

TOC Method : SCS TR-55

Sheet Flow Equation :

$$T_c = (0.007 * ((n * L_f)^{0.8}) / ((P^{0.5}) * (S_f^{0.4})))$$

Where :

T<sub>c</sub> = Time of Concentration (hr)  
 n = Manning's roughness  
 L<sub>f</sub> = Flow Length (ft)  
 P = 2 yr, 24 hr Rainfall (inches)  
 S<sub>f</sub> = Slope (ft/ft)

Shallow Concentrated Flow Equation :

V = 16.1345 \* (S<sub>f</sub><sup>0.5</sup>) (unpaved surface)  
 V = 20.3282 \* (S<sub>f</sub><sup>0.5</sup>) (paved surface)  
 V = 15.0 \* (S<sub>f</sub><sup>0.5</sup>) (grassed waterway surface)  
 V = 10.0 \* (S<sub>f</sub><sup>0.5</sup>) (nearly bare & untilled surface)  
 V = 9.0 \* (S<sub>f</sub><sup>0.5</sup>) (cultivated straight rows surface)  
 V = 7.0 \* (S<sub>f</sub><sup>0.5</sup>) (short grass pasture surface)  
 V = 5.0 \* (S<sub>f</sub><sup>0.5</sup>) (woodland surface)  
 V = 2.5 \* (S<sub>f</sub><sup>0.5</sup>) (forest w/heavy litter surface)  
 T<sub>c</sub> = (L<sub>f</sub> / V) / (3600 sec/hr)

Where:

T<sub>c</sub> = Time of Concentration (hr)  
 L<sub>f</sub> = Flow Length (ft)  
 V = Velocity (ft/sec)  
 S<sub>f</sub> = Slope (ft/ft)

Channel Flow Equation :

V = (1.49 \* (R<sup>2/3</sup>) \* (S<sub>f</sub><sup>0.5</sup>)) / n  
 R = A<sub>q</sub> / W<sub>p</sub>  
 T<sub>c</sub> = (L<sub>f</sub> / V) / (3600 sec/hr)

Where :

T<sub>c</sub> = Time of Concentration (hr)  
 L<sub>f</sub> = Flow Length (ft)  
 R = Hydraulic Radius (ft)  
 A<sub>q</sub> = Flow Area (ft<sup>2</sup>)  
 W<sub>p</sub> = Wetted Perimeter (ft)  
 V = Velocity (ft/sec)  
 S<sub>f</sub> = Slope (ft/ft)  
 n = Manning's roughness

Sheet Flow Computations	Subarea	Subarea	Subarea
	A	B	C
Manning's Roughness :	.6	0.00	0.00
Flow Length (ft) :	100	0.00	0.00
Slope (%) :	32.75	0.00	0.00
2 yr, 24 hr Rainfall (in) :	3.00	0.00	0.00
Velocity (ft/sec) :	0.17	0.00	0.00
Computed Flow Time (min) :	10.03	0.00	0.00
	Subarea	Subarea	Subarea
	A	B	C
Shallow Concentrated Flow Computations			
Flow Length (ft) :	870	1086	0.00
Slope (%) :	5.65	.76	0.00
Surface Type :	Woodland	Grassed waterway	Unpaved
Velocity (ft/sec) :	1.19	1.31	0.00
Computed Flow Time (min) :	12.18	13.82	0.00
Total TOC (min) .....	36.03		

**Subbasin Runoff Results**

Total Rainfall (in) .....	5.40
Total Runoff (in) .....	2.72
Peak Runoff (cfs) .....	35.56
Weighted Curve Number .....	74.38
Time of Concentration (days hh:mm:ss) .....	0 00:36:02

Subbasin : A

Rainfall Intensity Graph

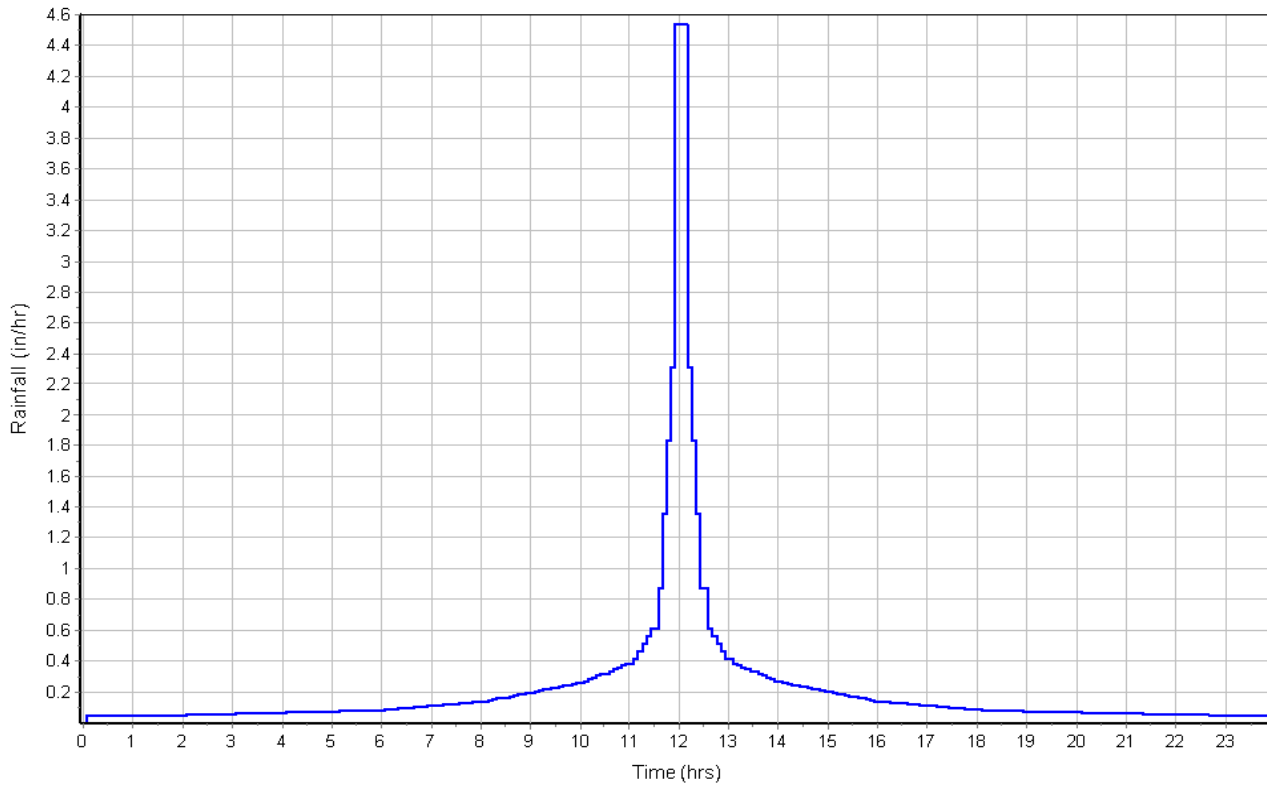

Runoff Hydrograph

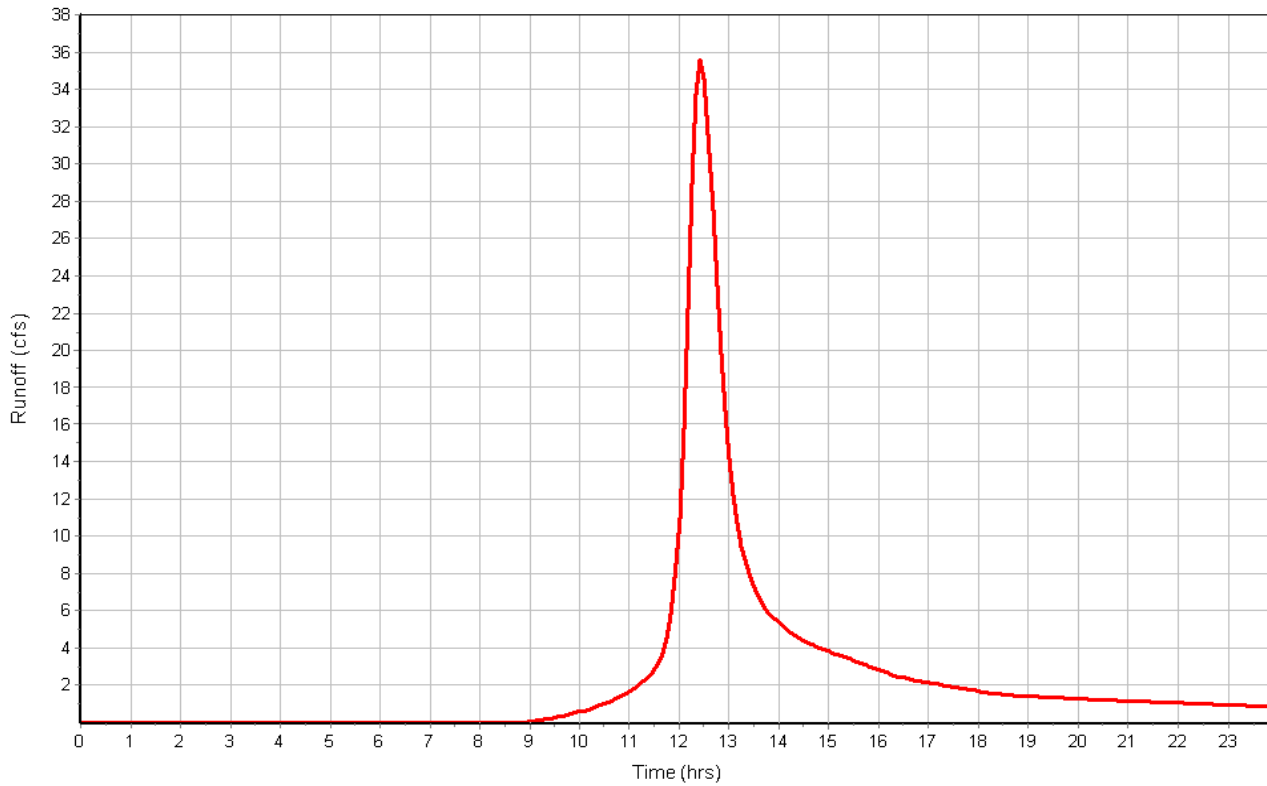

**Subbasin : B**

**Input Data**

Area (ac) ..... 5.93  
 Weighted Curve Number ..... 75.63  
 Rain Gage ID ..... Rain Gage-01

**Composite Curve Number**

Soil/Surface Description	Area (acres)	Soil Group	Curve Number
Woods, Good	1.16	C	70.00
Woods, Good	4.77	D	77.00
Composite Area & Weighted CN	5.93		75.63

**Time of Concentration**

	Subarea	Subarea	Subarea
	A	B	C
Sheet Flow Computations			
Manning's Roughness :	.6	0.00	0.00
Flow Length (ft) :	100	0.00	0.00
Slope (%) :	34	0.00	0.00
2 yr, 24 hr Rainfall (in) :	3.00	0.00	0.00
Velocity (ft/sec) :	0.17	0.00	0.00
Computed Flow Time (min) :	9.88	0.00	0.00
Shallow Concentrated Flow Computations			
Flow Length (ft) :	440	0.00	0.00
Slope (%) :	10	0.00	0.00
Surface Type :	Woodland	Unpaved	Unpaved
Velocity (ft/sec) :	1.58	0.00	0.00
Computed Flow Time (min) :	4.64	0.00	0.00
Total TOC (min) .....	14.52		

**Subbasin Runoff Results**

Total Rainfall (in) ..... 5.40  
 Total Runoff (in) ..... 2.84  
 Peak Runoff (cfs) ..... 14.75  
 Weighted Curve Number ..... 75.63  
 Time of Concentration (days hh:mm:ss) ..... 0 00:14:31

Subbasin : B

Rainfall Intensity Graph

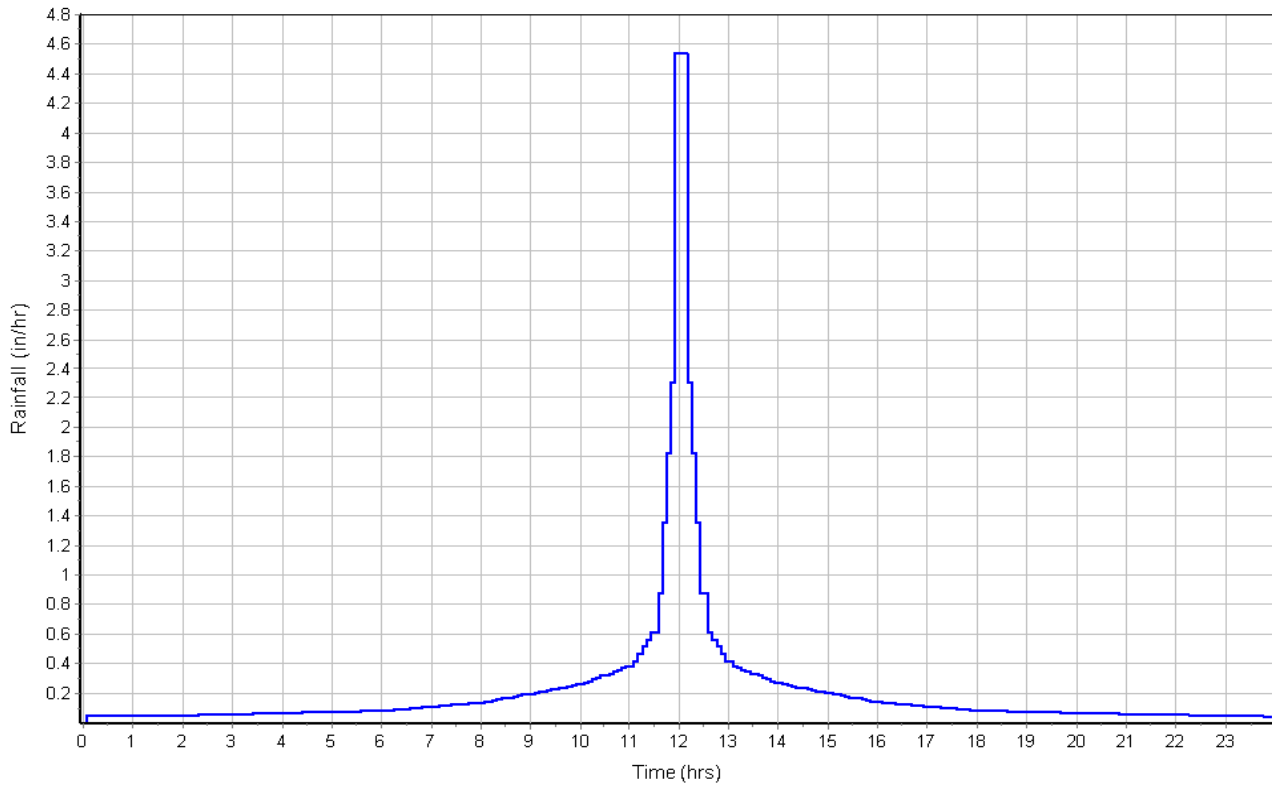

Runoff Hydrograph

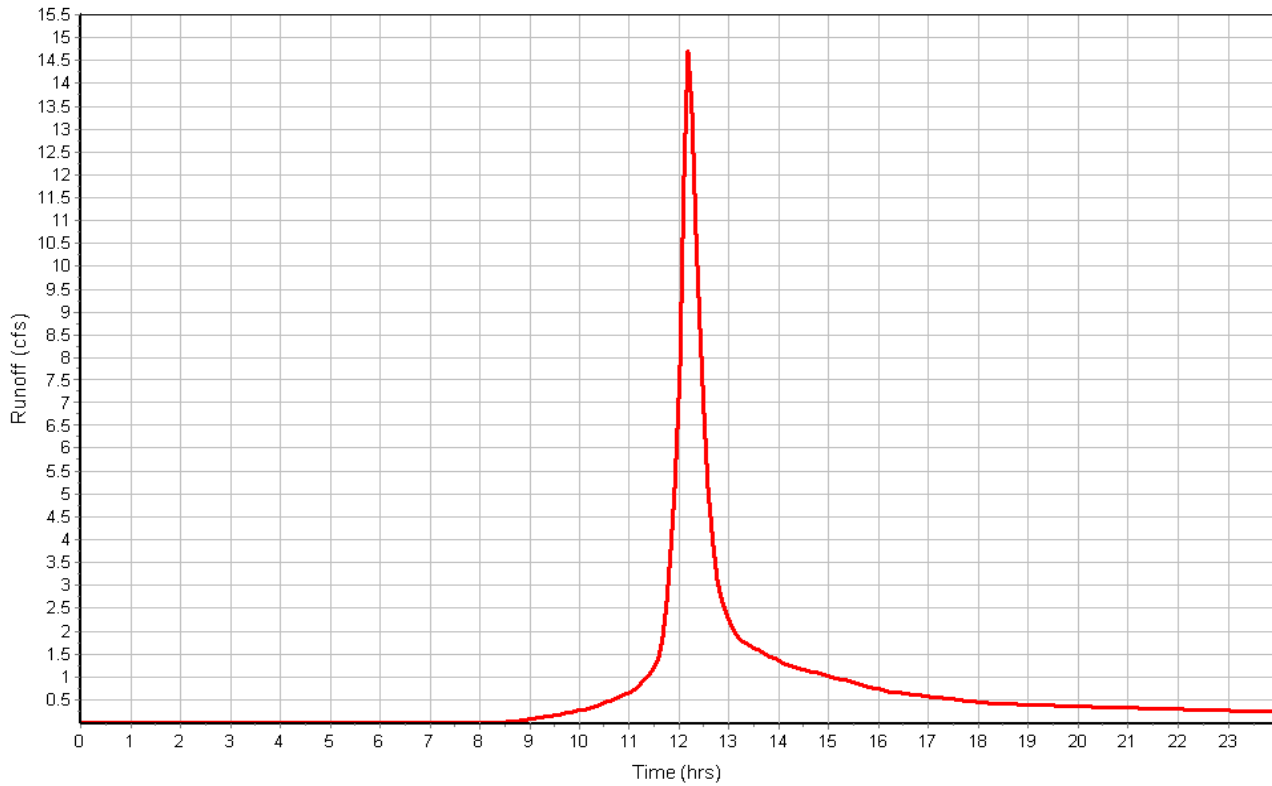



**Subbasin : C**

**Input Data**

Area (ac) ..... 17.44  
 Weighted Curve Number ..... 72.99  
 Rain Gage ID ..... Rain Gage-01

**Composite Curve Number**

Soil/Surface Description	Area (acres)	Soil Group	Curve Number
Woods, Good	10.00	C	70.00
Woods, Good	7.44	D	77.00
Composite Area & Weighted CN	17.44		72.99

**Time of Concentration**

Sheet Flow Computations	Subarea	Subarea	Subarea
	A	B	C
Manning's Roughness :	.6	0.00	0.00
Flow Length (ft) :	100	0.00	0.00
Slope (%) :	1.61	0.00	0.00
2 yr, 24 hr Rainfall (in) :	3.00	0.00	0.00
Velocity (ft/sec) :	0.05	0.00	0.00
Computed Flow Time (min) :	33.46	0.00	0.00

Shallow Concentrated Flow Computations	Subarea	Subarea	Subarea
	A	B	C
Flow Length (ft) :	2142	0.00	0.00
Slope (%) :	.47	0.00	0.00
Surface Type :	Grassed waterway	Unpaved	Unpaved
Velocity (ft/sec) :	1.03	0.00	0.00
Computed Flow Time (min) :	34.66	0.00	0.00
Total TOC (min) .....	68.12		

**Subbasin Runoff Results**

Total Rainfall (in) ..... 5.40  
 Total Runoff (in) ..... 2.60  
 Peak Runoff (cfs) ..... 19.86  
 Weighted Curve Number ..... 72.99  
 Time of Concentration (days hh:mm:ss) ..... 0 01:08:07

Subbasin : C

Rainfall Intensity Graph

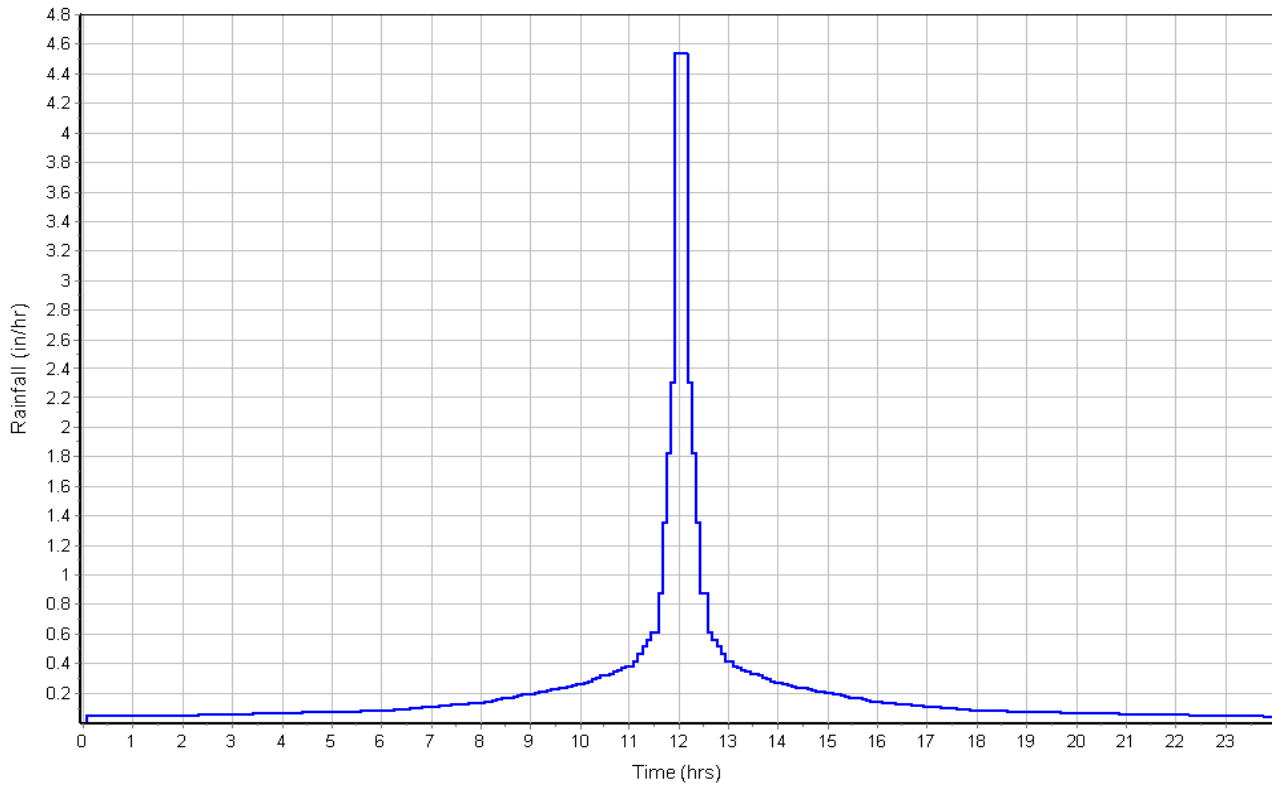

Runoff Hydrograph

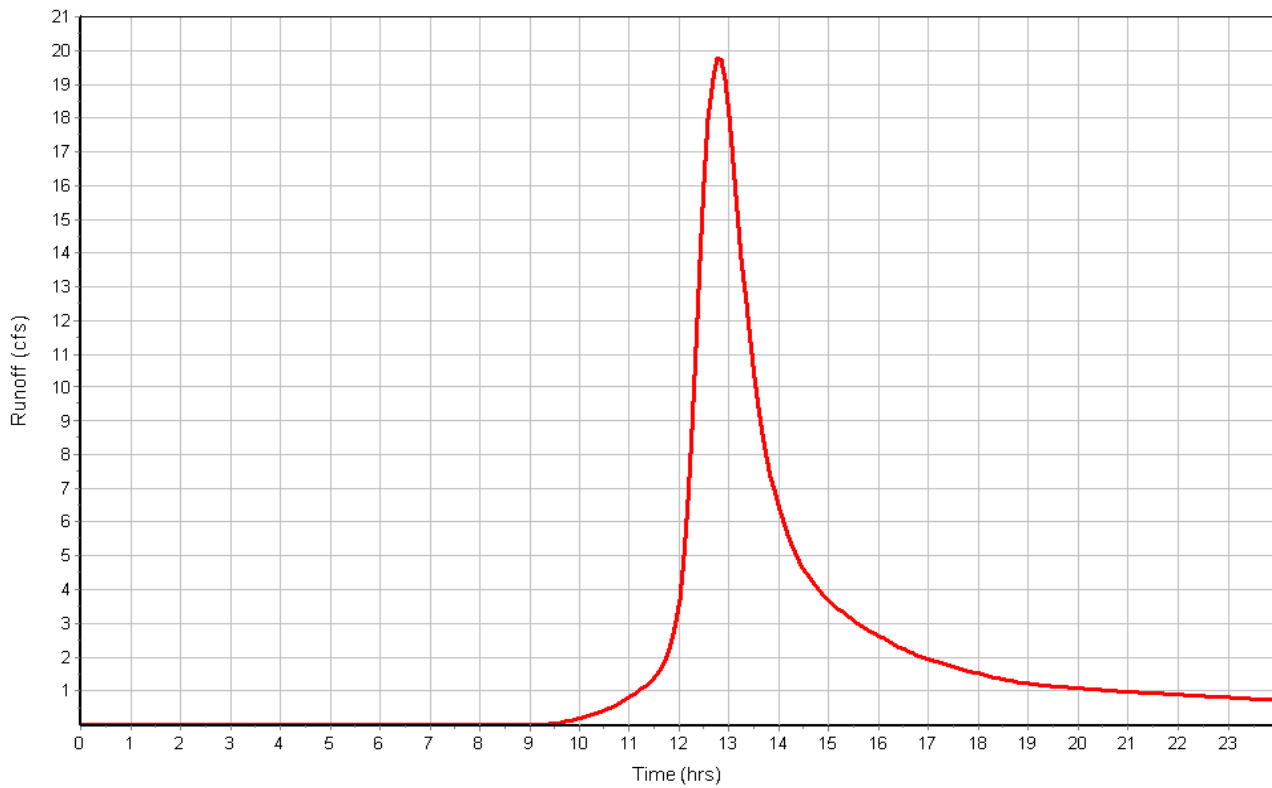

**Subbasin : D**

**Input Data**

Area (ac) ..... 0.74  
 Weighted Curve Number ..... 77.00  
 Rain Gage ID ..... Rain Gage-01

**Composite Curve Number**

Soil/Surface Description	Area (acres)	Soil Group	Curve Number
Woods, Good	0.74	D	77.00
Composite Area & Weighted CN	0.74		77.00

**Time of Concentration**

	Subarea A	Subarea B	Subarea C
<b>Sheet Flow Computations</b>			
Manning's Roughness :	.6	0.00	0.00
Flow Length (ft) :	100	0.00	0.00
Slope (%) :	23.2	0.00	0.00
2 yr, 24 hr Rainfall (in) :	3.00	0.00	0.00
Velocity (ft/sec) :	0.14	0.00	0.00
Computed Flow Time (min) :	11.51	0.00	0.00
<b>Shallow Concentrated Flow Computations</b>			
Flow Length (ft) :	33	0.00	0.00
Slope (%) :	14.75	0.00	0.00
Surface Type :	Woodland	Unpaved	Unpaved
Velocity (ft/sec) :	1.92	0.00	0.00
Computed Flow Time (min) :	0.29	0.00	0.00
Total TOC (min) .....	11.79		

**Subbasin Runoff Results**

Total Rainfall (in) ..... 5.40  
 Total Runoff (in) ..... 2.96  
 Peak Runoff (cfs) ..... 2.04  
 Weighted Curve Number ..... 77.00  
 Time of Concentration (days hh:mm:ss) ..... 0 00:11:47

Subbasin : D

Rainfall Intensity Graph

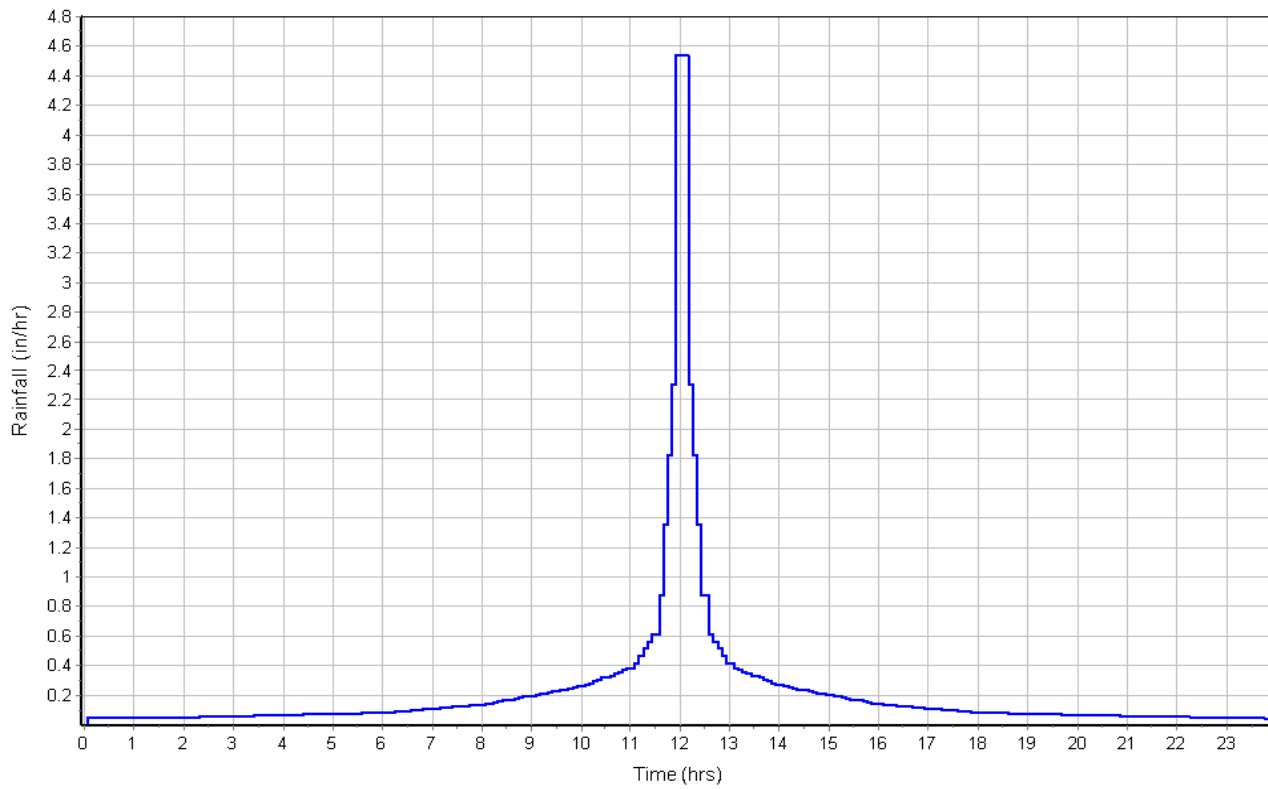

Runoff Hydrograph

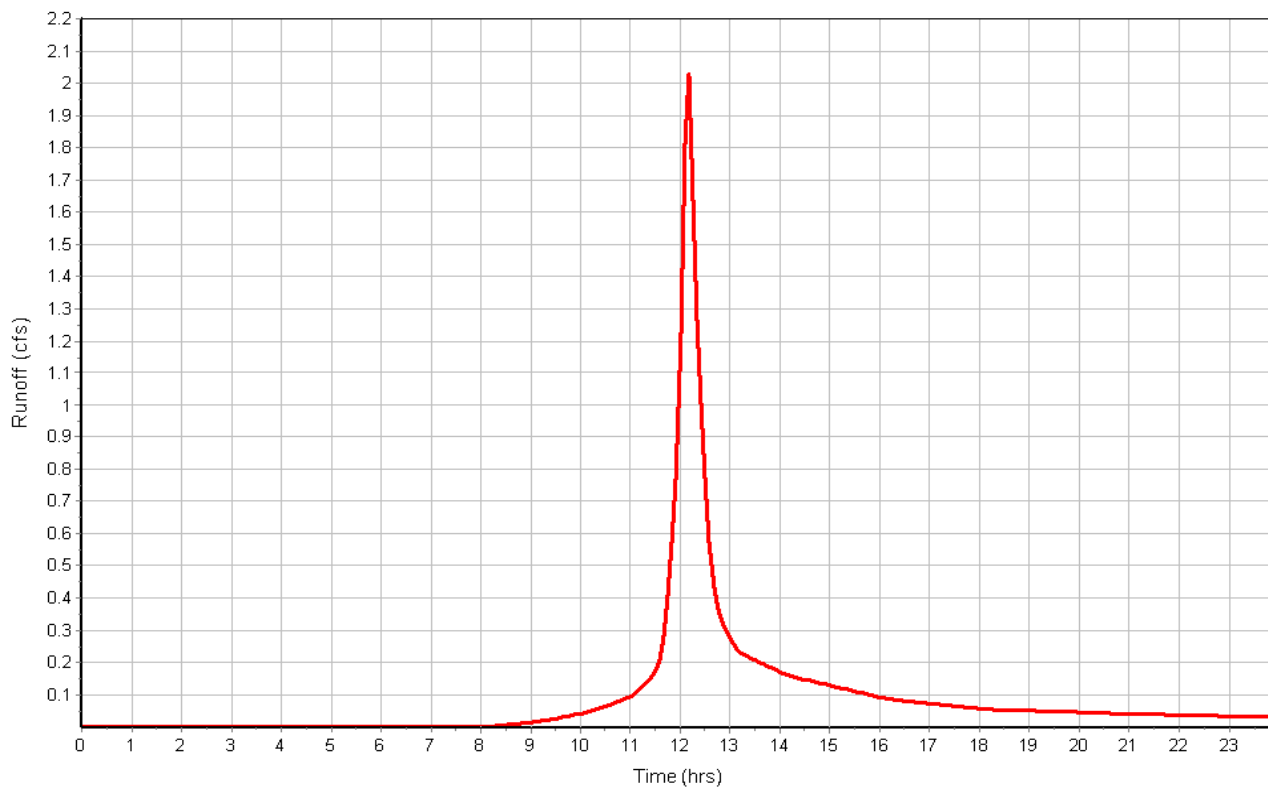

**Subbasin : E**

**Input Data**

Area (ac) ..... 3.72  
 Weighted Curve Number ..... 77.00  
 Rain Gage ID ..... Rain Gage-01

**Composite Curve Number**

Soil/Surface Description	Area (acres)	Soil Group	Curve Number
Woods, Good	3.72	D	77.00
Composite Area & Weighted CN	3.72		77.00

**Time of Concentration**

Sheet Flow Computations	Subarea	Subarea	Subarea
	A	B	C
Manning's Roughness :	.6	0.00	0.00
Flow Length (ft) :	100	0.00	0.00
Slope (%) :	14	0.00	0.00
2 yr, 24 hr Rainfall (in) :	3.00	0.00	0.00
Velocity (ft/sec) :	0.12	0.00	0.00
Computed Flow Time (min) :	14.09	0.00	0.00

Shallow Concentrated Flow Computations	Subarea	Subarea	Subarea
	A	B	C
Flow Length (ft) :	375	0.00	0.00
Slope (%) :	20.25	0.00	0.00
Surface Type :	Woodland	Unpaved	Unpaved
Velocity (ft/sec) :	2.25	0.00	0.00
Computed Flow Time (min) :	2.78	0.00	0.00
Total TOC (min) .....	16.86		

**Subbasin Runoff Results**

Total Rainfall (in) ..... 5.40  
 Total Runoff (in) ..... 2.96  
 Peak Runoff (cfs) ..... 9.23  
 Weighted Curve Number ..... 77.00  
 Time of Concentration (days hh:mm:ss) ..... 0 00:16:52

Subbasin : E

Rainfall Intensity Graph

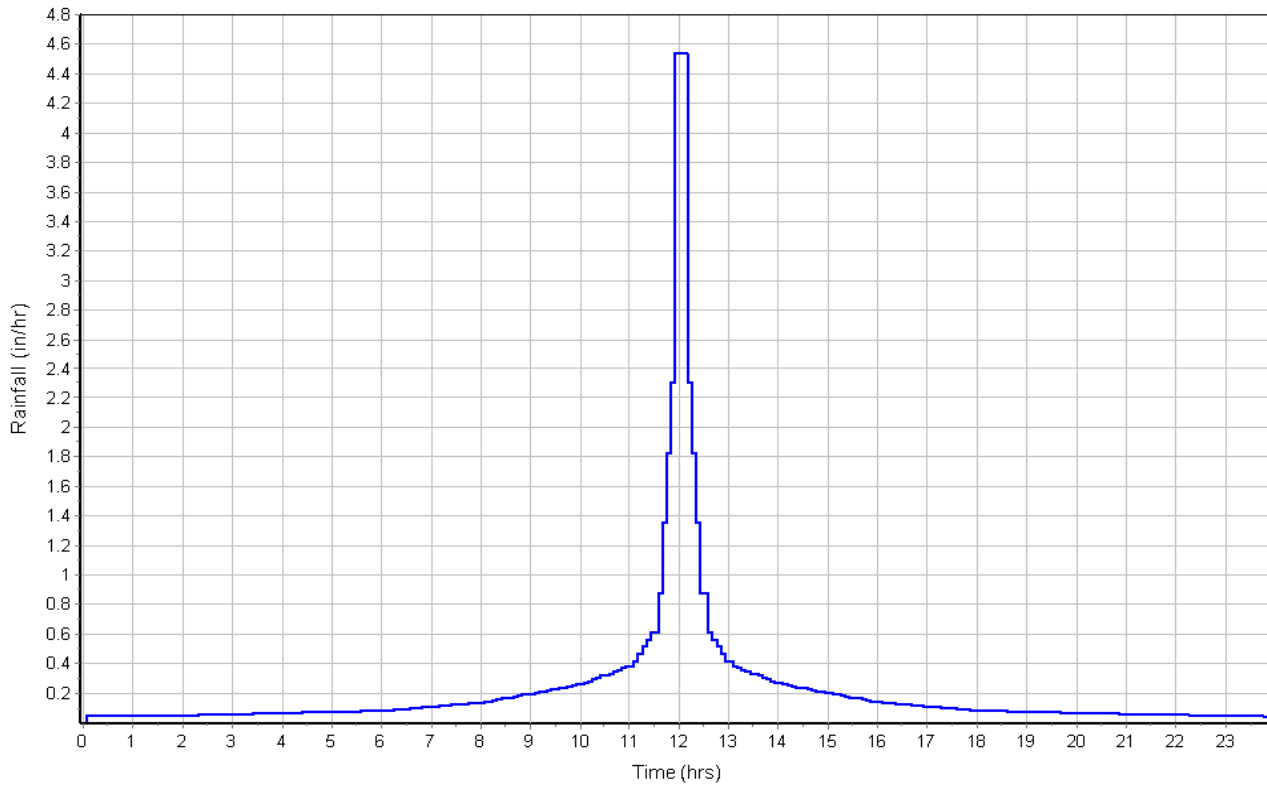

Runoff Hydrograph

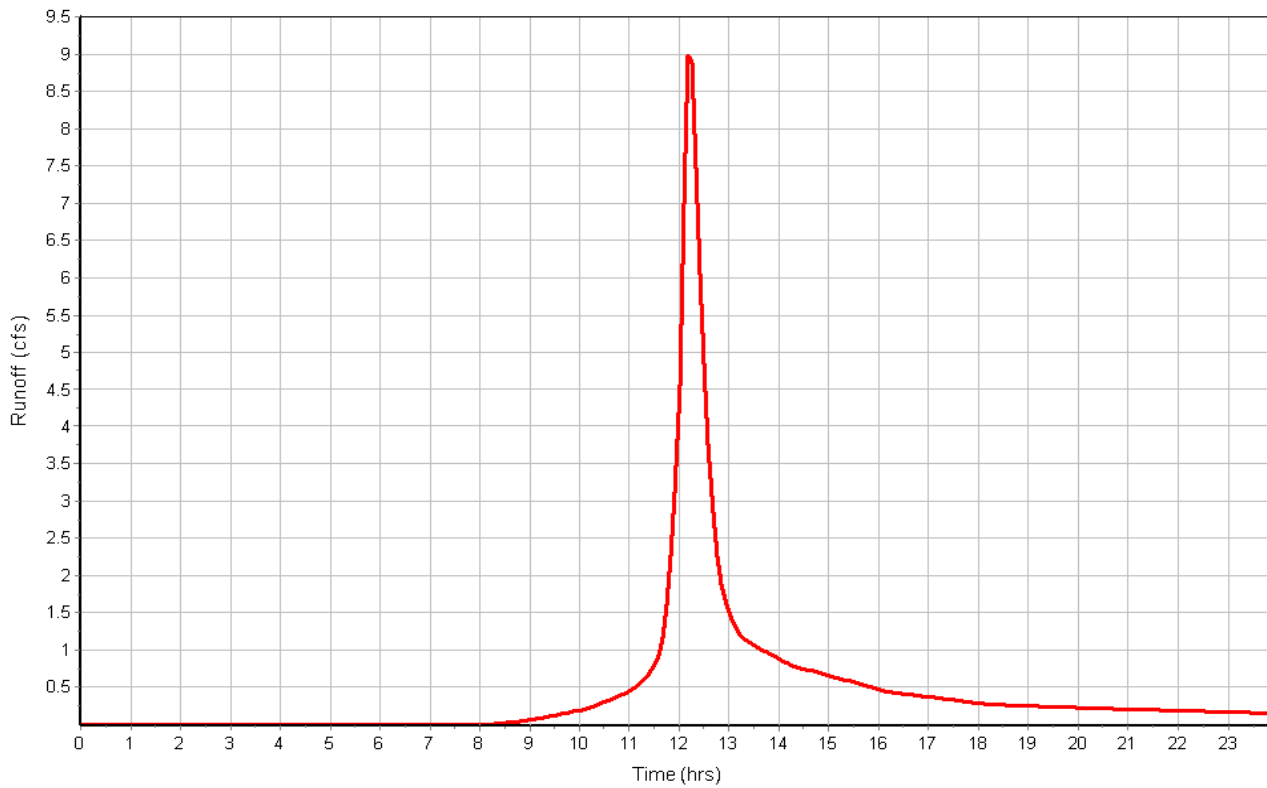

## Project Description

File Name ..... Proposed Conditions 5-30-18.SPF

## Project Options

Flow Units ..... CFS  
 Elevation Type ..... Elevation  
 Hydrology Method ..... SCS TR-55  
 Time of Concentration (TOC) Method ..... SCS TR-55  
 Link Routing Method ..... Kinematic Wave  
 Enable Overflow Ponding at Nodes ..... YES  
 Skip Steady State Analysis Time Periods ..... NO

## Analysis Options

Start Analysis On ..... Jul 13, 2017 00:00:00  
 End Analysis On ..... Jul 14, 2017 00:00:00  
 Start Reporting On ..... Jul 13, 2017 00:00:00  
 Antecedent Dry Days ..... 0 days  
 Runoff (Dry Weather) Time Step ..... 0 01:00:00 days hh:mm:ss  
 Runoff (Wet Weather) Time Step ..... 0 00:05:00 days hh:mm:ss  
 Reporting Time Step ..... 0 00:05:00 days hh:mm:ss  
 Routing Time Step ..... 30 seconds

## Number of Elements

Qty  
 Rain Gages ..... 1  
 Subbasins..... 8  
 Nodes..... 12  
     *Junctions* ..... 4  
     *Outfalls* ..... 5  
     *Flow Diversions* ..... 0  
     *Inlets* ..... 0  
     *Storage Nodes* ..... 3  
 Links..... 10  
     *Channels* ..... 0  
     *Pipes* ..... 4  
     *Pumps* ..... 0  
     *Orifices* ..... 4  
     *Weirs* ..... 2  
     *Outlets* ..... 0  
 Pollutants ..... 0  
 Land Uses ..... 0

## Rainfall Details

SN	Rain Gage ID	Data Source	Data Source ID	Rainfall Type	Rain Units	State	County	Return Period (years)	Rainfall Depth (inches)	Rainfall Distribution
1	Rain Gage-01	Time Series	TS-02	Cumulative	inches	Maine	Androscoggin	2	3.00	SCS Type III 24-hr

## Subbasin Summary

Subbasin ID	Area (ac)	Weighted Curve Number	Total Rainfall (in)	Total Runoff (in)	Total Runoff Volume (ac-in)	Peak Runoff (cfs)	Time of Concentration (days hh:mm:ss)
A1	12.28	73.16	3.00	0.87	10.62	5.16	0 00:49:44
A2	6.41	81.47	3.00	1.34	8.62	7.78	0 00:12:48
A3	4.01	71.75	3.00	0.80	3.19	2.90	0 00:09:08
B	4.99	75.82	3.00	1.01	5.01	3.50	0 00:24:28
C1	15.70	73.25	3.00	0.87	13.66	5.97	0 00:59:49
C2	2.05	82.98	3.00	1.45	2.96	2.25	0 00:22:00
D	0.59	77.00	3.00	1.07	0.63	0.56	0 00:12:07
E	2.86	77.00	3.00	1.07	3.06	2.68	0 00:13:08



## Node Summary

Element ID	Element Type	Invert Elevation
		(ft)
CB1	Junction	305.30
CB2	Junction	312.00
OUTLET-STR-A2	Junction	305.60
OUTLET-STR-C2	Junction	299.00
OUT-A	Outfall	298.00
OUT-B	Outfall	310.00
OUT-C	Outfall	298.00
OUT-D	Outfall	338.00
OUT-E	Outfall	298.00
DETENTION-A	Storage Node	309.50
FILTER-A2	Storage Node	308.00
FILTER-C2	Storage Node	301.50

## Link Summary

Element ID	Element Type	From (Inlet) Node	To (Outlet) Node	Length	Inlet Invert Elevation	Outlet Invert Elevation	Average Slope	Diameter or Height	Manning's Roughness	Peak Flow	Design Flow Capacity	Peak Flow Velocity	Peak Flow Depth
				(ft)	(ft)	(ft)	(%)	(in)		(cfs)	(cfs)	(ft/sec)	(ft)
CULV-A	Pipe	CB1	OUT-A	98.00	305.30	305.12	0.1800	36.000	0.0150	6.96	24.77	3.01	1.09
CULV-A2-1	Pipe	CB2	FILTER-A2	104.00	312.00	310.00	1.9200	24.000	0.0150	7.73	27.19	7.47	0.73
CULV-A2-2	Pipe	OUTLET-STR-A2	CB1	43.00	305.60	305.30	0.7000	24.000	0.0150	5.15	16.38	4.61	0.77
CULV-C2	Pipe	OUTLET-STR-C2	OUT-C	40.00	299.00	298.00	2.5000	15.000	0.0150	0.00	8.85	0.00	0.00
BEEHIVE-GRATE	Orifice	DETENTION-A	CB1		309.50	305.30		18.167		0.00			
ORIF-A2	Orifice	FILTER-A2	OUTLET-STR-A2		308.00	305.60		6.000		5.15			
ORIF-C2	Orifice	FILTER-C2	OUTLET-STR-C2		301.50	299.00		4.000		0.00			
ORIF-DET-A	Orifice	DETENTION-A	CB1		309.50	305.30		4.000		1.81			
SPILLWAY-A2	Weir	FILTER-A2	DETENTION-A		308.00	309.50				0.00			
SPILLWAY-C2	Weir	FILTER-C2	OUT-C		301.50	298.00				0.00			

## Subbasin Hydrology

### Subbasin : A1

#### Input Data

Area (ac) ..... 12.28  
 Weighted Curve Number ..... 73.16  
 Rain Gage ID ..... Rain Gage-01

#### Composite Curve Number

Soil/Surface Description	Area (acres)	Soil Group	Curve Number
Woods, Good	4.58	D	77.00
> 75% grass cover, Good	0.68	C	74.00
Woods, Good	6.62	C	70.00
> 75% grass cover, Good	0.40	D	80.00
Composite Area & Weighted CN	12.28		73.16

#### Time of Concentration

TOC Method : SCS TR-55

Sheet Flow Equation :

$$T_c = (0.007 * ((n * L_f)^{0.8})) / ((P^{0.5}) * (S_f^{0.4}))$$

Where :

T<sub>c</sub> = Time of Concentration (hr)  
 n = Manning's roughness  
 L<sub>f</sub> = Flow Length (ft)  
 P = 2 yr, 24 hr Rainfall (inches)  
 S<sub>f</sub> = Slope (ft/ft)

Shallow Concentrated Flow Equation :

V = 16.1345 \* (S<sub>f</sub><sup>0.5</sup>) (unpaved surface)  
 V = 20.3282 \* (S<sub>f</sub><sup>0.5</sup>) (paved surface)  
 V = 15.0 \* (S<sub>f</sub><sup>0.5</sup>) (grassed waterway surface)  
 V = 10.0 \* (S<sub>f</sub><sup>0.5</sup>) (nearly bare & untilled surface)  
 V = 9.0 \* (S<sub>f</sub><sup>0.5</sup>) (cultivated straight rows surface)  
 V = 7.0 \* (S<sub>f</sub><sup>0.5</sup>) (short grass pasture surface)  
 V = 5.0 \* (S<sub>f</sub><sup>0.5</sup>) (woodland surface)  
 V = 2.5 \* (S<sub>f</sub><sup>0.5</sup>) (forest w/heavy litter surface)  
 T<sub>c</sub> = (L<sub>f</sub> / V) / (3600 sec/hr)

Where:

T<sub>c</sub> = Time of Concentration (hr)  
 L<sub>f</sub> = Flow Length (ft)  
 V = Velocity (ft/sec)  
 S<sub>f</sub> = Slope (ft/ft)

Channel Flow Equation :

V = (1.49 \* (R<sup>2/3</sup>) \* (S<sub>f</sub><sup>0.5</sup>)) / n  
 R = A<sub>q</sub> / W<sub>p</sub>  
 T<sub>c</sub> = (L<sub>f</sub> / V) / (3600 sec/hr)

Where :

T<sub>c</sub> = Time of Concentration (hr)  
 L<sub>f</sub> = Flow Length (ft)  
 R = Hydraulic Radius (ft)  
 A<sub>q</sub> = Flow Area (ft<sup>2</sup>)  
 W<sub>p</sub> = Wetted Perimeter (ft)  
 V = Velocity (ft/sec)  
 S<sub>f</sub> = Slope (ft/ft)  
 n = Manning's roughness

	Subarea	Subarea	Subarea
	A	B	C
<b>Sheet Flow Computations</b>			
Manning's Roughness :	.6	0.00	0.00
Flow Length (ft) :	100	0.00	0.00
Slope (%) :	2	0.00	0.00
2 yr, 24 hr Rainfall (in) :	3.00	0.00	0.00
Velocity (ft/sec) :	0.05	0.00	0.00
Computed Flow Time (min) :	30.68	0.00	0.00
<b>Shallow Concentrated Flow Computations</b>			
	Subarea	Subarea	Subarea
	A	B	C
Flow Length (ft) :	1510	0.00	0.00
Slope (%) :	.78	0.00	0.00
Surface Type :		Unpaved	Unpaved
Velocity (ft/sec) :	1.32	0.00	0.00
Computed Flow Time (min) :	19.07	0.00	0.00
Total TOC (min) .....	49.74		

**Subbasin Runoff Results**

Total Rainfall (in) .....	3.00
Total Runoff (in) .....	0.87
Peak Runoff (cfs) .....	5.16
Weighted Curve Number .....	73.16
Time of Concentration (days hh:mm:ss) .....	0 00:49:44

Subbasin : A1

Rainfall Intensity Graph

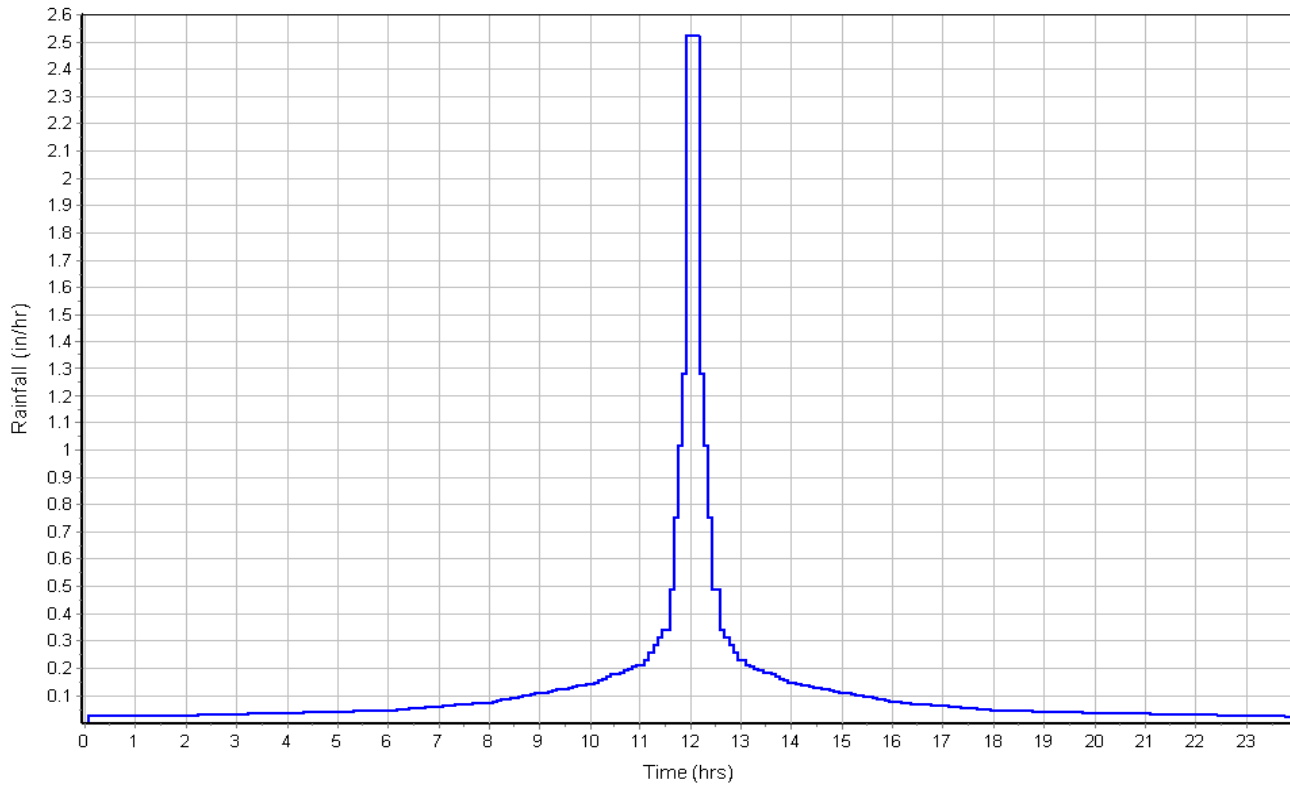

Runoff Hydrograph

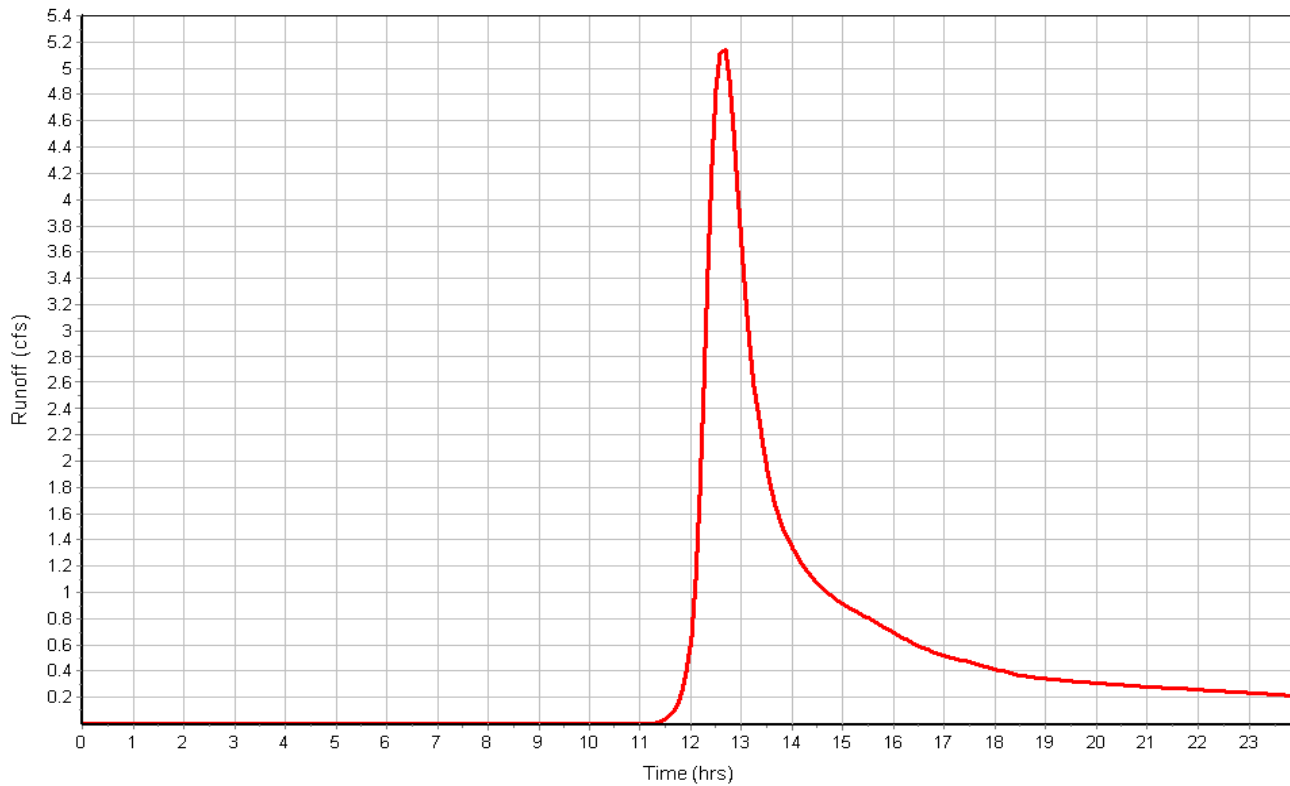

**Subbasin : A2**

**Input Data**

Area (ac) ..... 6.41  
 Weighted Curve Number ..... 81.47  
 Rain Gage ID ..... Rain Gage-01

**Composite Curve Number**

Soil/Surface Description	Area (acres)	Soil Group	Curve Number
Woods, Good	0.13	D	77.00
Roofs	1.77	D	98.00
> 75% grass cover, Good	1.87	D	80.00
Stone_Pad	1.80	D	60.00
Gravel roads	0.17	D	91.00
Pavement	0.67	D	98.00
Composite Area & Weighted CN	6.41		81.47

**Time of Concentration**

	Subarea		
	A	B	C
<b>Sheet Flow Computations</b>			
Manning's Roughness :	.4	0.00	0.00
Flow Length (ft) :	85	0.00	0.00
Slope (%) :	33.33	0.00	0.00
2 yr, 24 hr Rainfall (in) :	3.00	0.00	0.00
Velocity (ft/sec) :	0.22	0.00	0.00
Computed Flow Time (min) :	6.32	0.00	0.00
<b>Channel Flow Computations</b>			
Manning's Roughness :	.04	0.00	0.00
Flow Length (ft) :	1138	0.00	0.00
Channel Slope (%) :	1.4	0.00	0.00
Cross Section Area (ft <sup>2</sup> ) :	4.398	0.00	0.00
Wetted Perimeter (ft) :	8.12	0.00	0.00
Velocity (ft/sec) :	2.93	0.00	0.00
Computed Flow Time (min) :	6.48	0.00	0.00
Total TOC (min) .....	12.80		

**Subbasin Runoff Results**

Total Rainfall (in) ..... 3.00  
 Total Runoff (in) ..... 1.34  
 Peak Runoff (cfs) ..... 7.78  
 Weighted Curve Number ..... 81.47  
 Time of Concentration (days hh:mm:ss) ..... 0 00:12:48

Subbasin : A2

Rainfall Intensity Graph

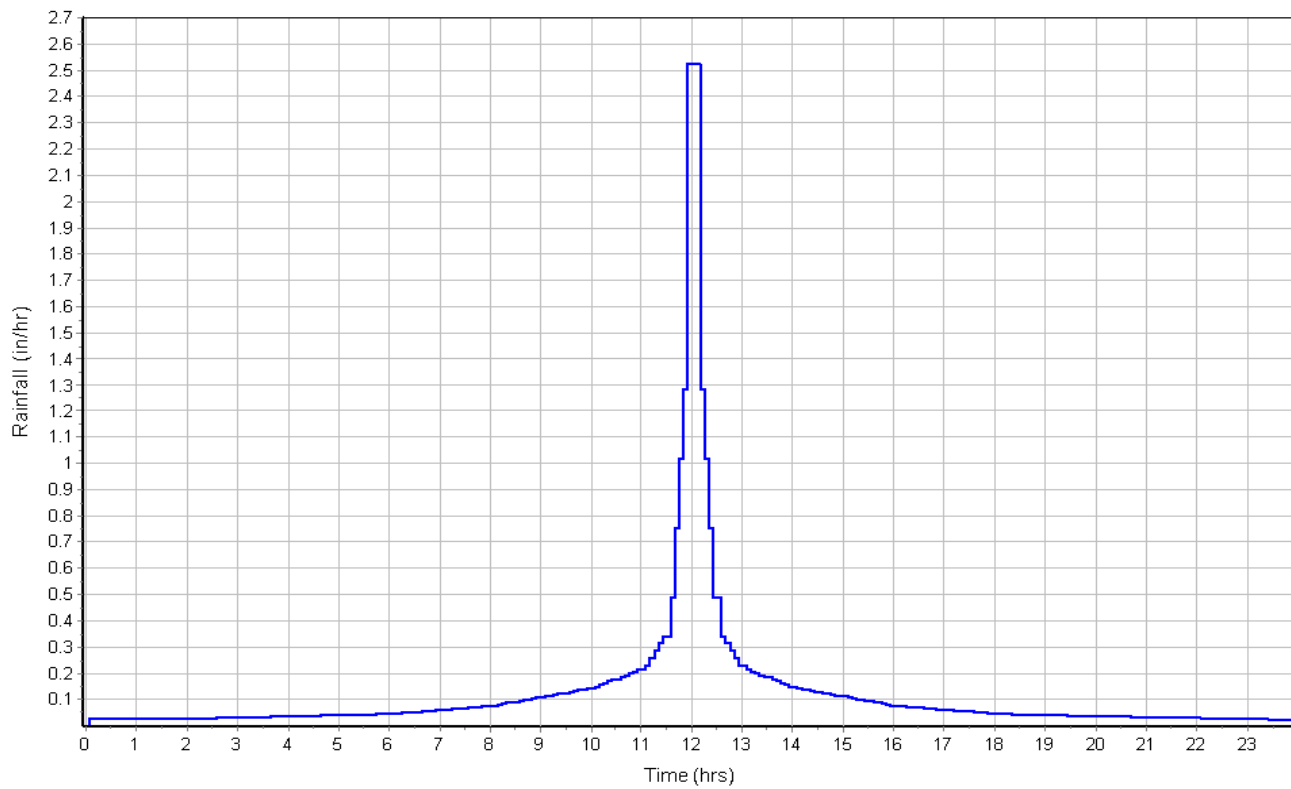

Runoff Hydrograph

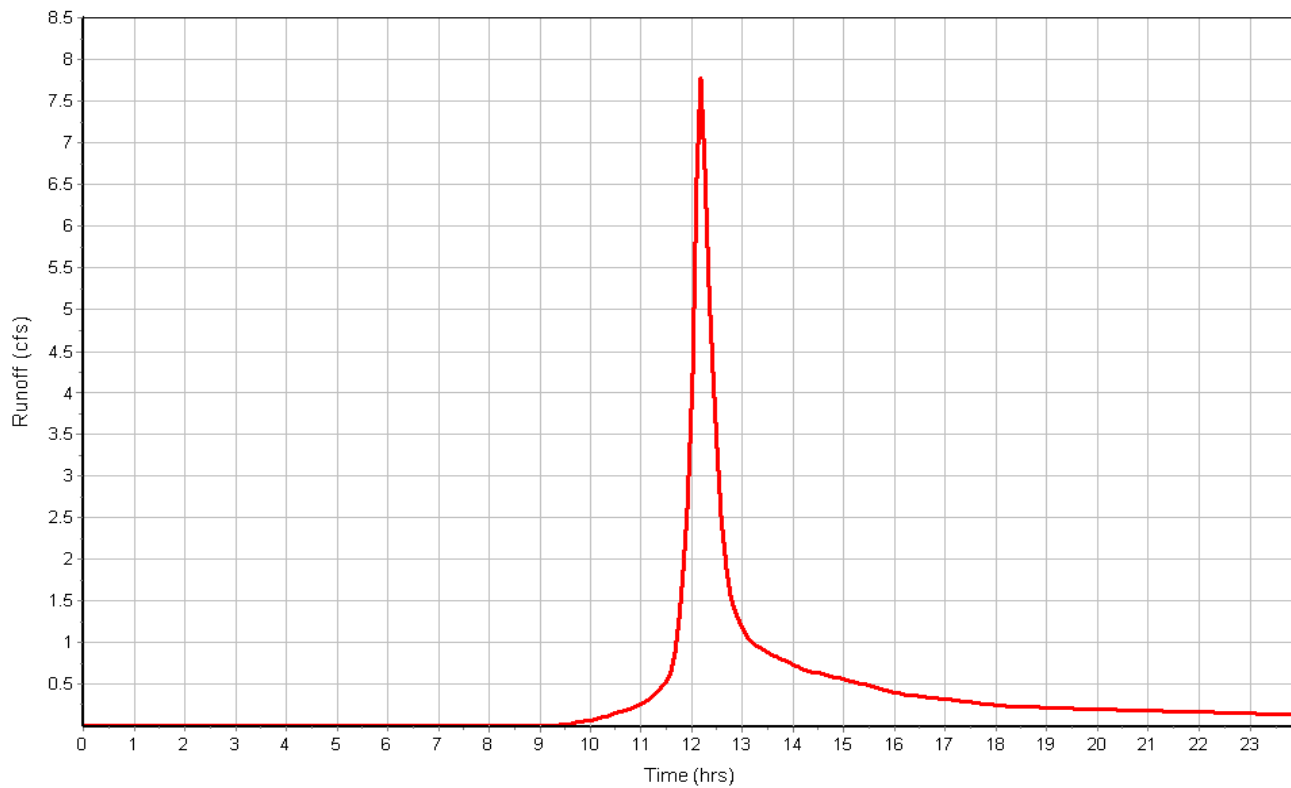

**Subbasin : A3**

**Input Data**

Area (ac) ..... 4.01  
 Weighted Curve Number ..... 71.75  
 Rain Gage ID ..... Rain Gage-01

**Composite Curve Number**

Soil/Surface Description	Area (acres)	Soil Group	Curve Number
> 75% grass cover, Good	0.75	D	80.00
> 75% grass cover, Good	0.14	C	74.00
Stone_Pad	2.28	D	60.00
Roofs	0.19	D	98.00
Gravel roads	0.25	D	91.00
Pavement	0.35	D	98.00
Foundations	0.05	D	98.00
Composite Area & Weighted CN	4.01		71.75

**Time of Concentration**

Sheet Flow Computations	Subarea	Subarea	Subarea
	A	B	C
Manning's Roughness :	.01	0.00	0.00
Flow Length (ft) :	100	0.00	0.00
Slope (%) :	2	0.00	0.00
2 yr, 24 hr Rainfall (in) :	3.00	0.00	0.00
Velocity (ft/sec) :	1.44	0.00	0.00
Computed Flow Time (min) :	1.16	0.00	0.00

Shallow Concentrated Flow Computations	Subarea	Subarea	Subarea
	A	B	C
Flow Length (ft) :	548	25	200
Slope (%) :	2	33.33	1.5
Surface Type :	Unpaved		
Velocity (ft/sec) :	2.28	4.04	0.86
Computed Flow Time (min) :	4.01	0.10	3.88
Total TOC (min) .....	9.14		

**Subbasin Runoff Results**

Total Rainfall (in) ..... 3.00  
 Total Runoff (in) ..... 0.80  
 Peak Runoff (cfs) ..... 2.90  
 Weighted Curve Number ..... 71.75  
 Time of Concentration (days hh:mm:ss) ..... 0 00:09:08



Subbasin : A3

Rainfall Intensity Graph

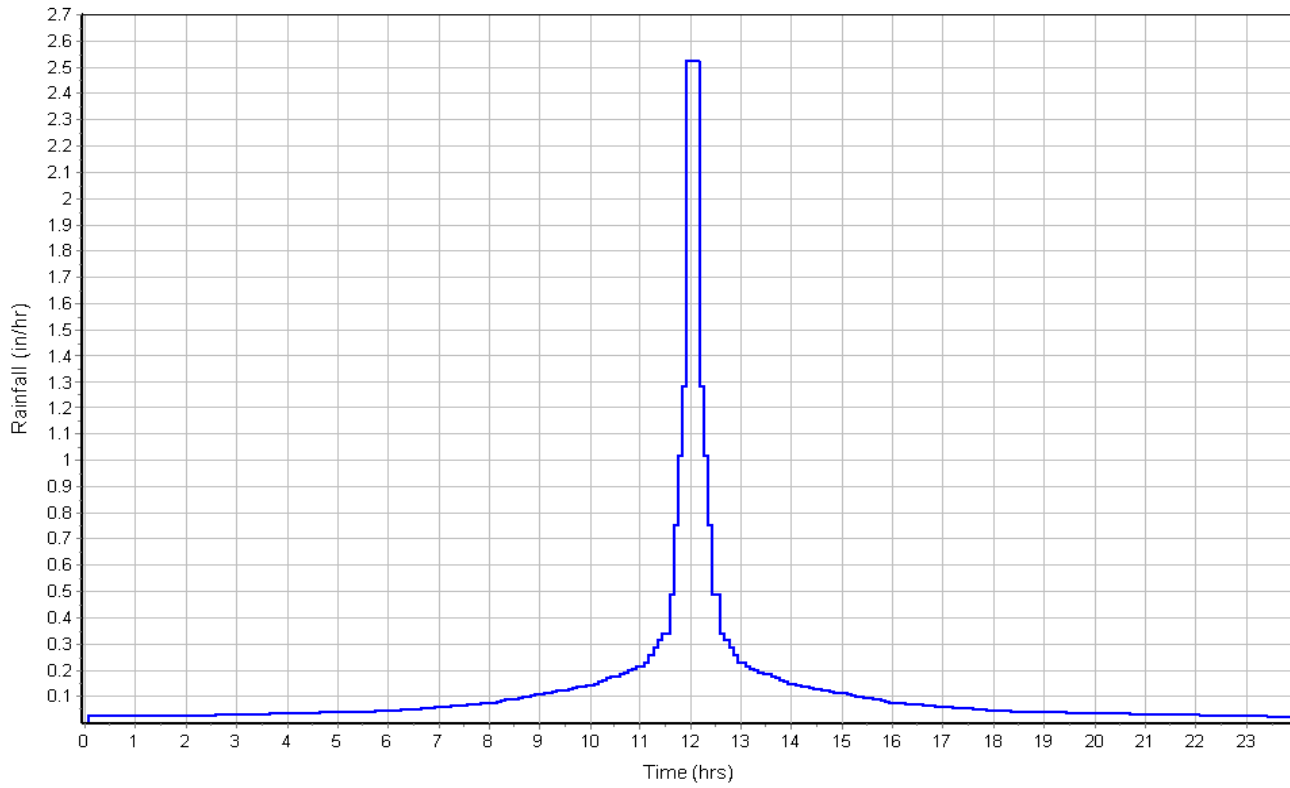

Runoff Hydrograph

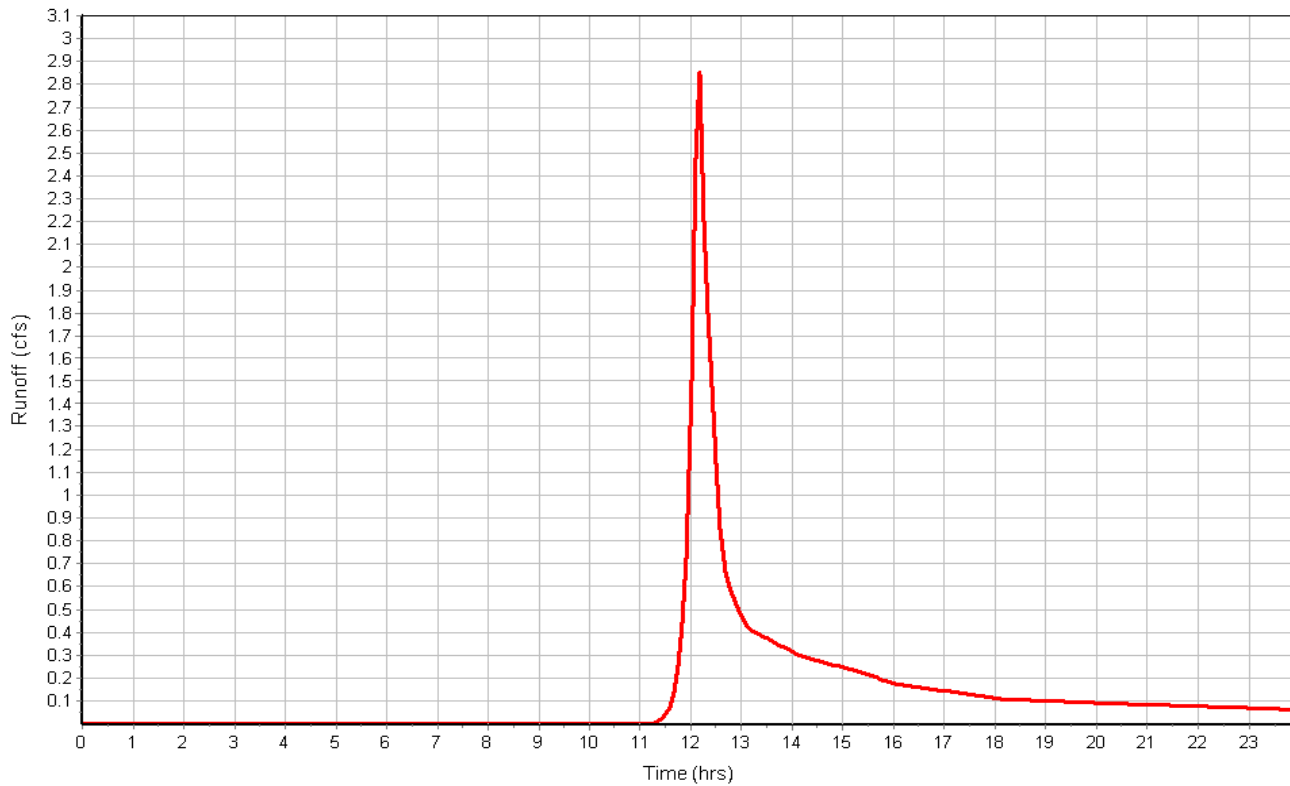

**Subbasin : B**

**Input Data**

Area (ac) ..... 4.99  
 Weighted Curve Number ..... 75.82  
 Rain Gage ID ..... Rain Gage-01

**Composite Curve Number**

Soil/Surface Description	Area (acres)	Soil Group	Curve Number
Woods, Good	1.05	C	70.00
Woods, Good	3.45	D	77.00
> 75% grass cover, Good	0.49	D	80.00
Composite Area & Weighted CN	4.99		75.82

**Time of Concentration**

	Subarea		
	A	B	C
<b>Sheet Flow Computations</b>			
Manning's Roughness :	.4	0.00	0.00
Flow Length (ft) :	90	0.00	0.00
Slope (%) :	33.33	0.00	0.00
2 yr, 24 hr Rainfall (in) :	3.00	0.00	0.00
Velocity (ft/sec) :	0.23	0.00	0.00
Computed Flow Time (min) :	6.62	0.00	0.00
<b>Shallow Concentrated Flow Computations</b>			
Flow Length (ft) :	368	0.00	0.00
Slope (%) :	1.63	0.00	0.00
Surface Type :		Unpaved	Unpaved
Velocity (ft/sec) :	1.92	0.00	0.00
Computed Flow Time (min) :	3.19	0.00	0.00
<b>Channel Flow Computations</b>			
Manning's Roughness :	.3	.3	0.00
Flow Length (ft) :	272	85	0.00
Channel Slope (%) :	1.4	16.7	0.00
Cross Section Area (ft²) :	3.287	1.367	0.00
Wetted Perimeter (ft) :	7.17	5.15	0.00
Velocity (ft/sec) :	0.35	0.84	0.00
Computed Flow Time (min) :	12.97	1.69	0.00
Total TOC (min) .....	24.48		

**Subbasin Runoff Results**

Total Rainfall (in) ..... 3.00  
 Total Runoff (in) ..... 1.01  
 Peak Runoff (cfs) ..... 3.50  
 Weighted Curve Number ..... 75.82  
 Time of Concentration (days hh:mm:ss) ..... 0 00:24:29

**Subbasin : B**

**Rainfall Intensity Graph**

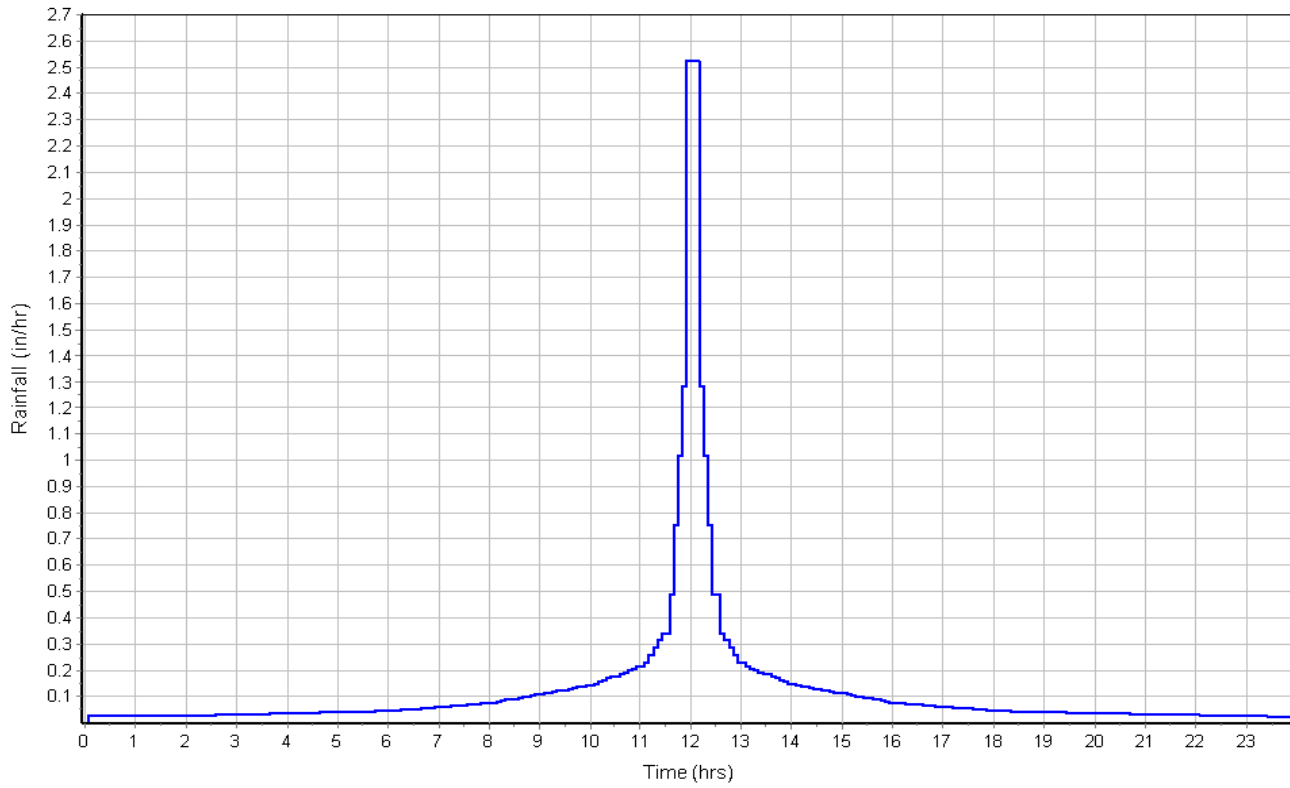

**Runoff Hydrograph**

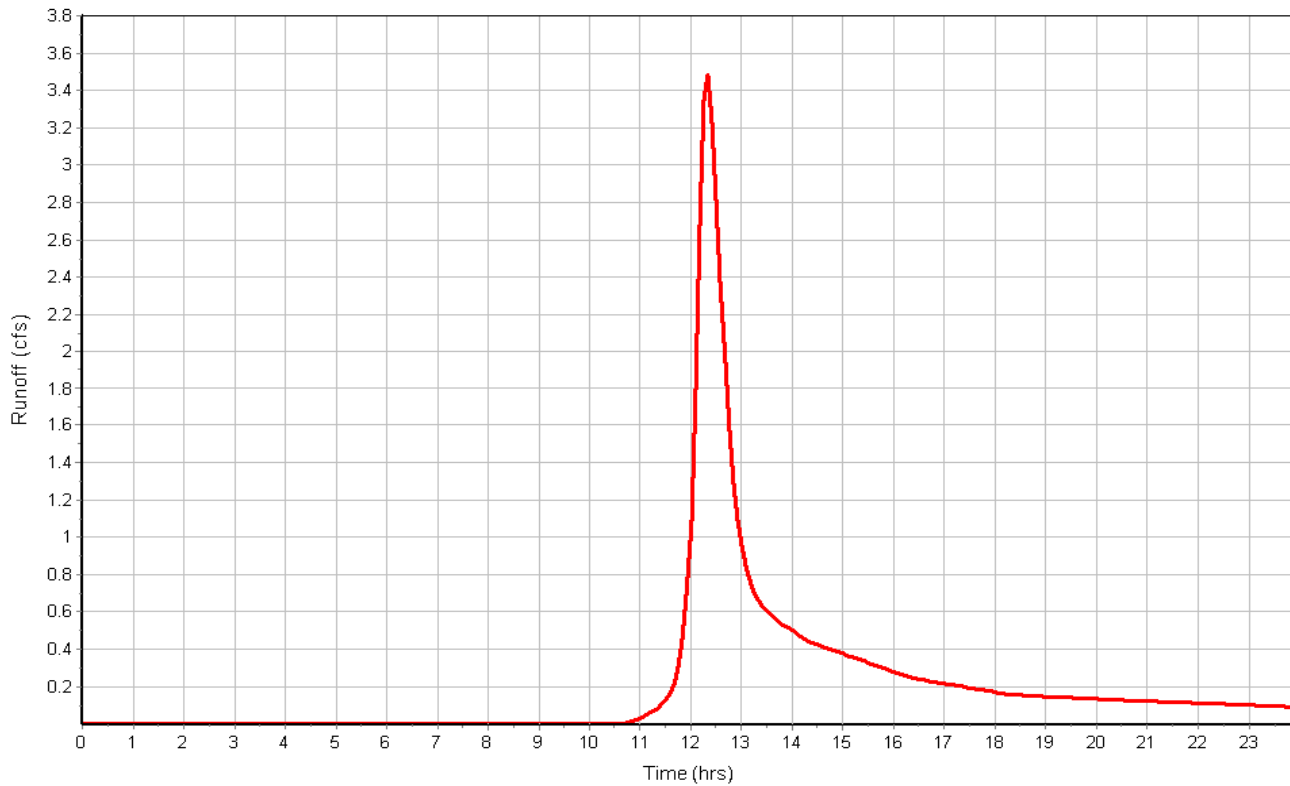

**Subbasin : C1**

**Input Data**

Area (ac) ..... 15.70  
 Weighted Curve Number ..... 73.25  
 Rain Gage ID ..... Rain Gage-01

**Composite Curve Number**

Soil/Surface Description	Area (acres)	Soil Group	Curve Number
Gravel roads	0.17	D	91.00
> 75% grass cover, Good	0.04	D	80.00
Woods, Good	8.63	C	70.00
Woods, Good	6.55	D	77.00
> 75% grass cover, Good	0.31	C	74.00
Composite Area & Weighted CN	15.70		73.25

**Time of Concentration**

Sheet Flow Computations	Subarea	Subarea	Subarea
	A	B	C
Manning's Roughness :	.6	0.00	0.00
Flow Length (ft) :	100	0.00	0.00
Slope (%) :	2	0.00	0.00
2 yr, 24 hr Rainfall (in) :	3.00	0.00	0.00
Velocity (ft/sec) :	0.05	0.00	0.00
Computed Flow Time (min) :	30.68	0.00	0.00

Shallow Concentrated Flow Computations	Subarea	Subarea	Subarea
	A	B	C
Flow Length (ft) :	1907	0.00	0.00
Slope (%) :	.524	0.00	0.00
Surface Type :		Unpaved	Unpaved
Velocity (ft/sec) :	1.09	0.00	0.00
Computed Flow Time (min) :	29.16	0.00	0.00
Total TOC (min) .....	59.83		

**Subbasin Runoff Results**

Total Rainfall (in) ..... 3.00  
 Total Runoff (in) ..... 0.87  
 Peak Runoff (cfs) ..... 5.97  
 Weighted Curve Number ..... 73.25  
 Time of Concentration (days hh:mm:ss) ..... 0 00:59:50

Subbasin : C1

Rainfall Intensity Graph

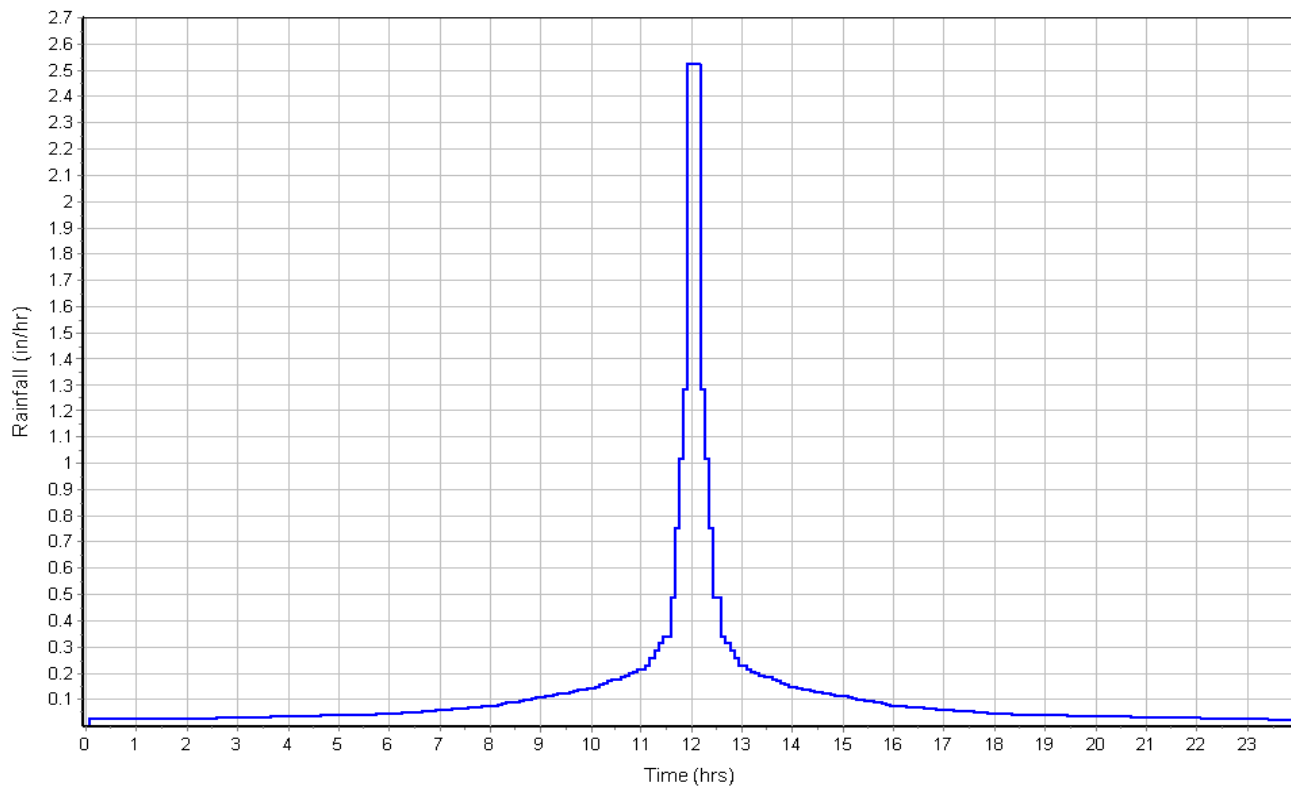

Runoff Hydrograph

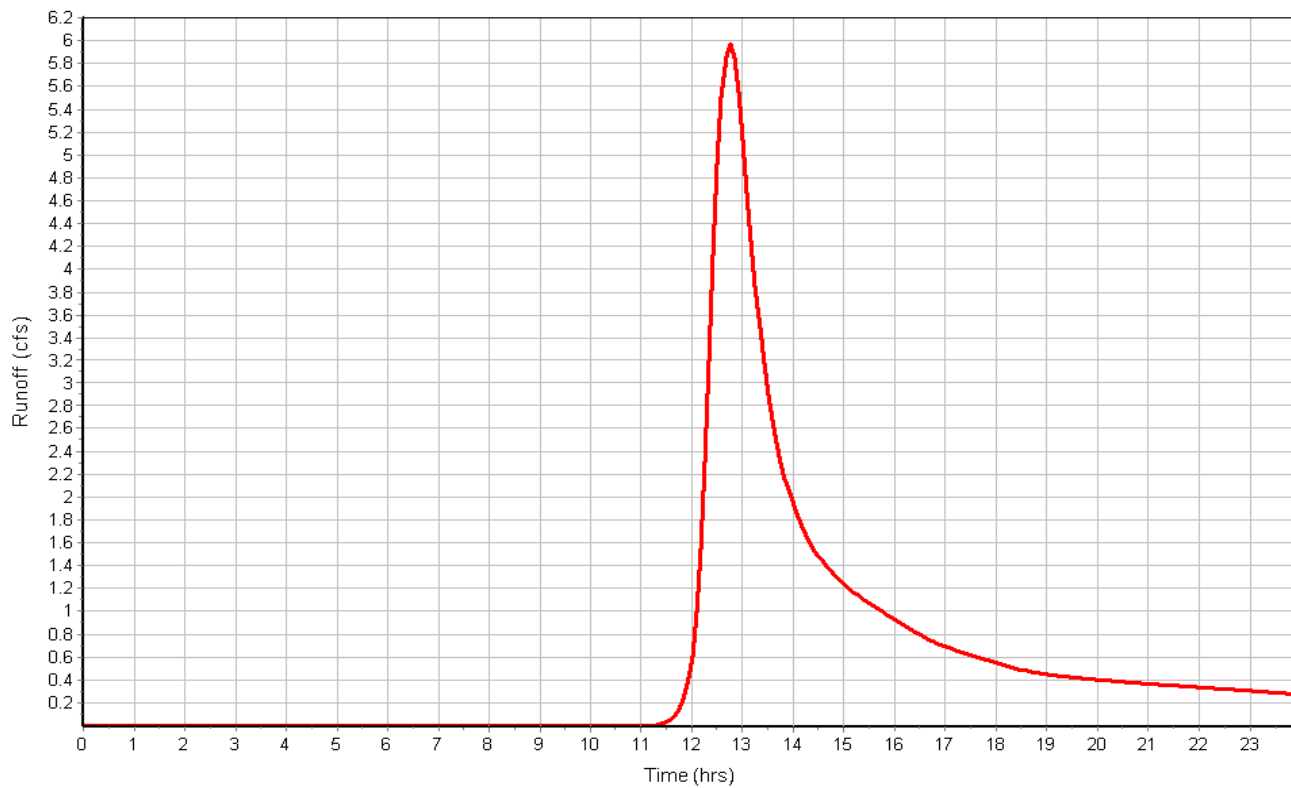

**Subbasin : C2**

**Input Data**

Area (ac) ..... 2.05  
 Weighted Curve Number ..... 82.98  
 Rain Gage ID ..... Rain Gage-01

**Composite Curve Number**

Soil/Surface Description	Area (acres)	Soil Group	Curve Number
> 75% grass cover, Good	0.32	D	80.00
> 75% grass cover, Good	0.76	C	74.00
Gravel roads	0.97	D	91.00
Composite Area & Weighted CN	2.05		82.98

**Time of Concentration**

	Subarea		
	A	B	C
<b>Sheet Flow Computations</b>			
Manning's Roughness :	.01	0.00	0.00
Flow Length (ft) :	60	0.00	0.00
Slope (%) :	2	0.00	0.00
2 yr, 24 hr Rainfall (in) :	3.00	0.00	0.00
Velocity (ft/sec) :	1.30	0.00	0.00
Computed Flow Time (min) :	0.77	0.00	0.00
<b>Channel Flow Computations</b>			
Manning's Roughness :	.03	0.00	0.00
Flow Length (ft) :	2256	0.00	0.00
Channel Slope (%) :	.5	0.00	0.00
Cross Section Area (ft <sup>2</sup> ) :	2.475	0.00	0.00
Wetted Perimeter (ft) :	6.91	0.00	0.00
Velocity (ft/sec) :	1.77	0.00	0.00
Computed Flow Time (min) :	21.23	0.00	0.00
Total TOC (min) .....	22.00		

**Subbasin Runoff Results**

Total Rainfall (in) ..... 3.00  
 Total Runoff (in) ..... 1.45  
 Peak Runoff (cfs) ..... 2.25  
 Weighted Curve Number ..... 82.98  
 Time of Concentration (days hh:mm:ss) ..... 0 00:22:00

Subbasin : C2

Rainfall Intensity Graph

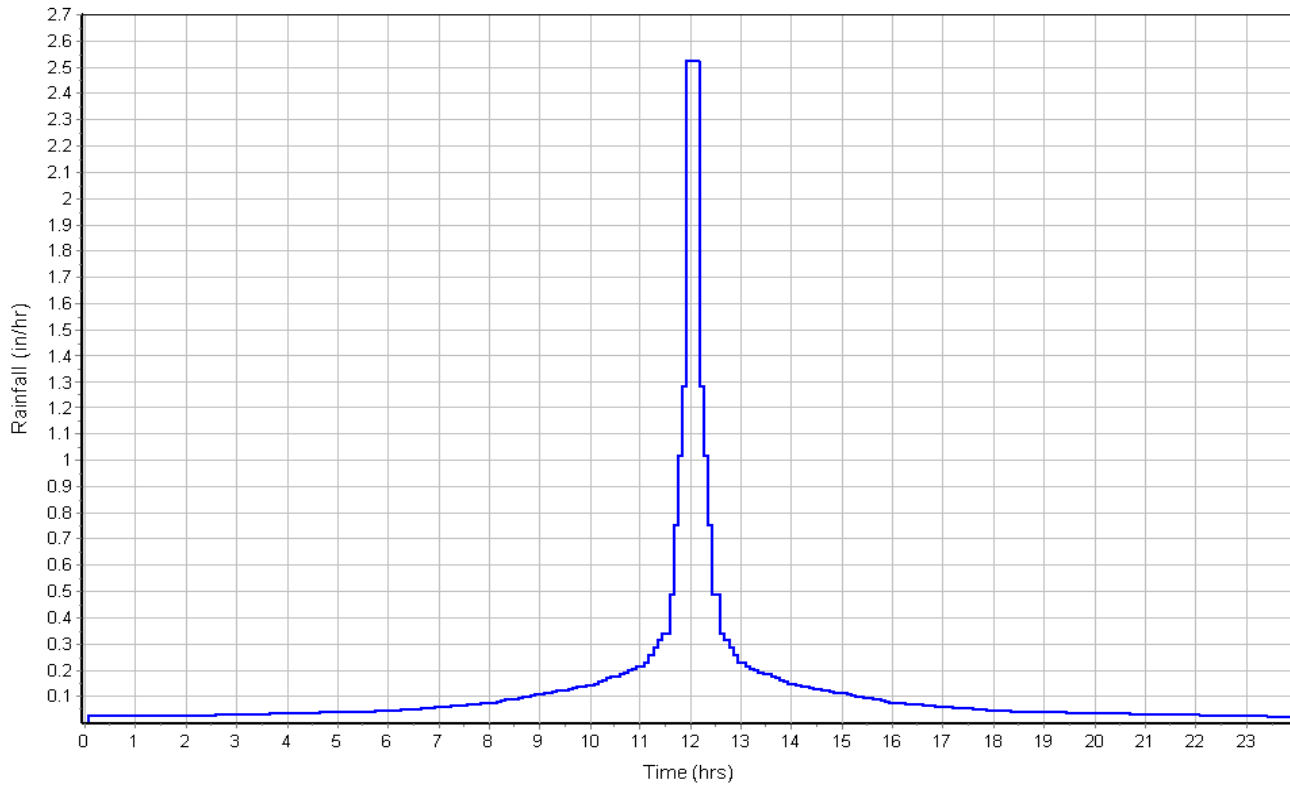

Runoff Hydrograph

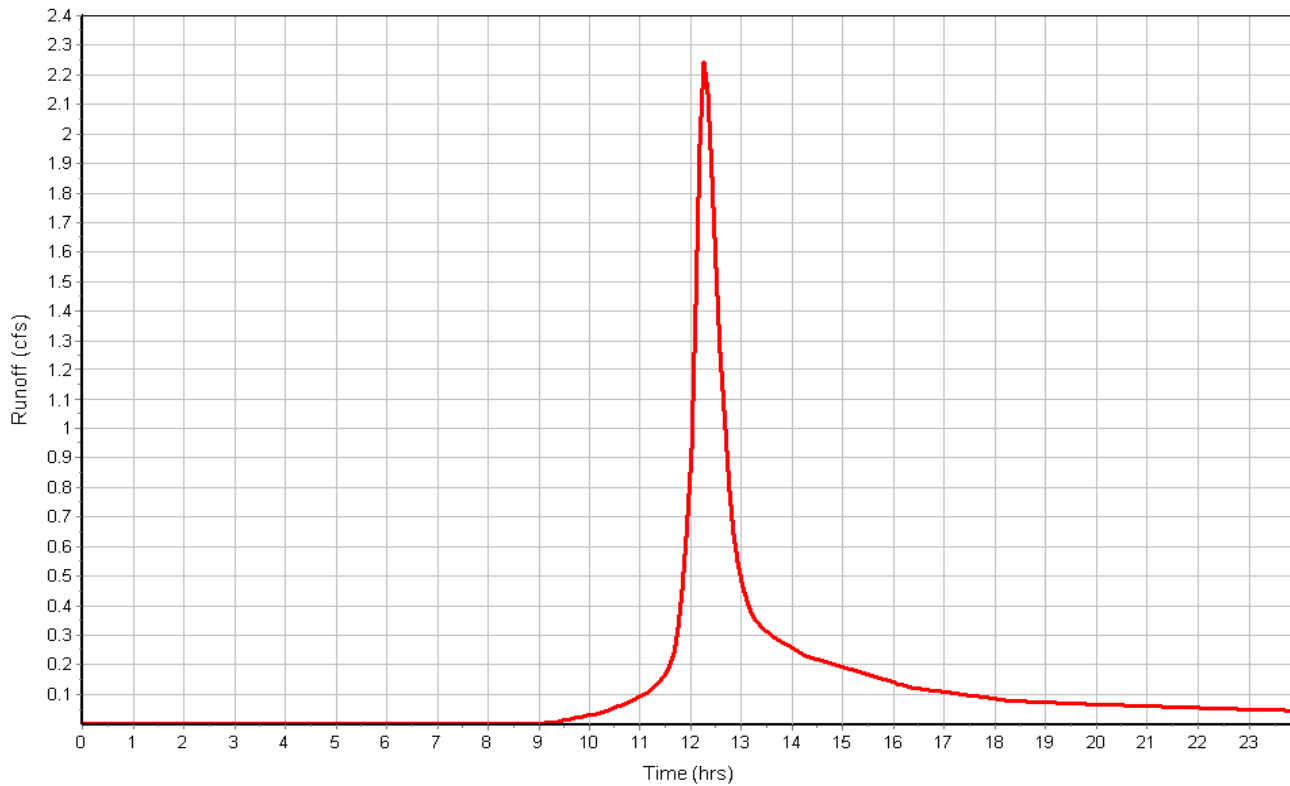

**Subbasin : D**

**Input Data**

Area (ac) ..... 0.59  
 Weighted Curve Number ..... 77.00  
 Rain Gage ID ..... Rain Gage-01

**Composite Curve Number**

Soil/Surface Description	Area (acres)	Soil Group	Curve Number
Woods, Good	0.59	D	77.00
Composite Area & Weighted CN	0.59		77.00

**Time of Concentration**

Sheet Flow Computations	Subarea	Subarea	Subarea
	A	B	C
Manning's Roughness :	.6	0.00	0.00
Flow Length (ft) :	100	0.00	0.00
Slope (%) :	21	0.00	0.00
2 yr, 24 hr Rainfall (in) :	3.00	0.00	0.00
Velocity (ft/sec) :	0.14	0.00	0.00
Computed Flow Time (min) :	11.98	0.00	0.00

Shallow Concentrated Flow Computations	Subarea	Subarea	Subarea
	A	B	C
Flow Length (ft) :	16	0.00	0.00
Slope (%) :	14.5	0.00	0.00
Surface Type :	Woodland	Unpaved	Unpaved
Velocity (ft/sec) :	1.90	0.00	0.00
Computed Flow Time (min) :	0.14	0.00	0.00
Total TOC (min) .....	12.12		

**Subbasin Runoff Results**

Total Rainfall (in) ..... 3.00  
 Total Runoff (in) ..... 1.07  
 Peak Runoff (cfs) ..... 0.56  
 Weighted Curve Number ..... 77.00  
 Time of Concentration (days hh:mm:ss) ..... 0 00:12:07



Subbasin : D

Rainfall Intensity Graph

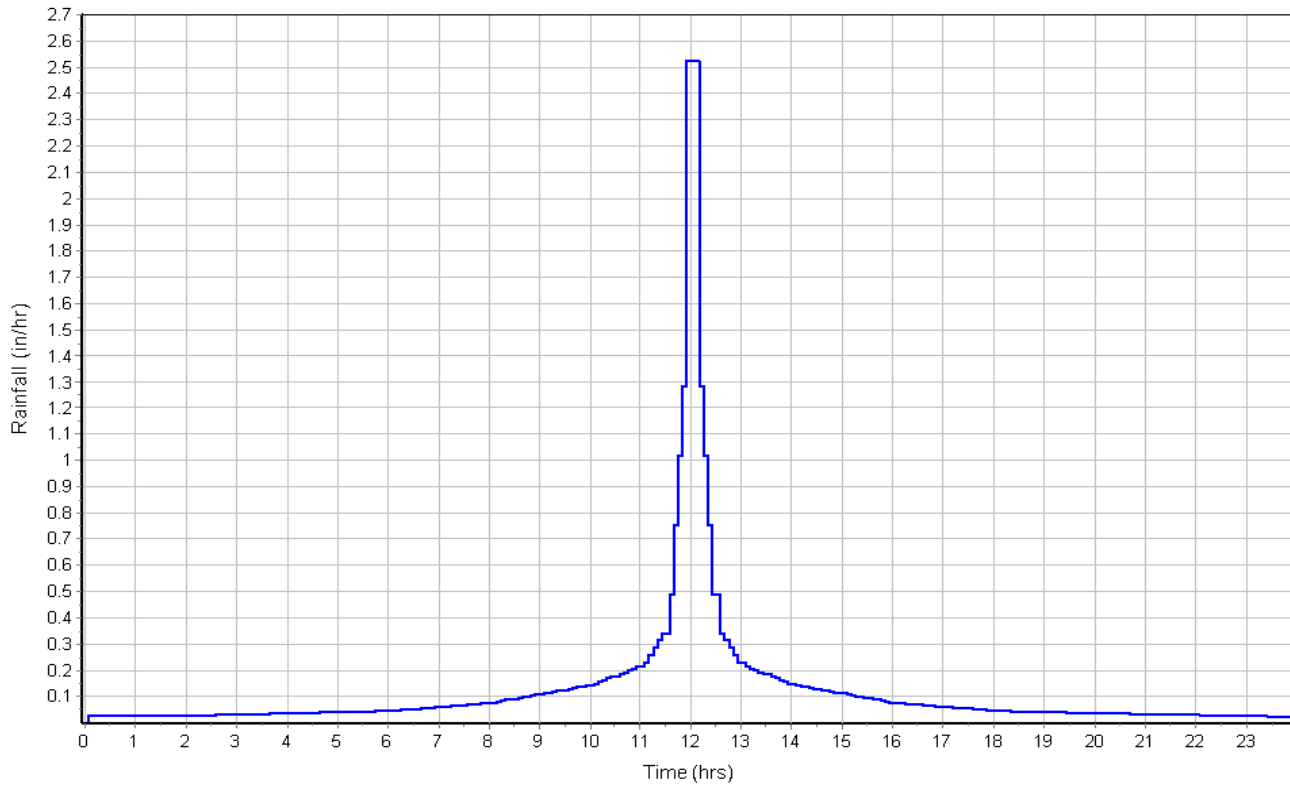

Runoff Hydrograph

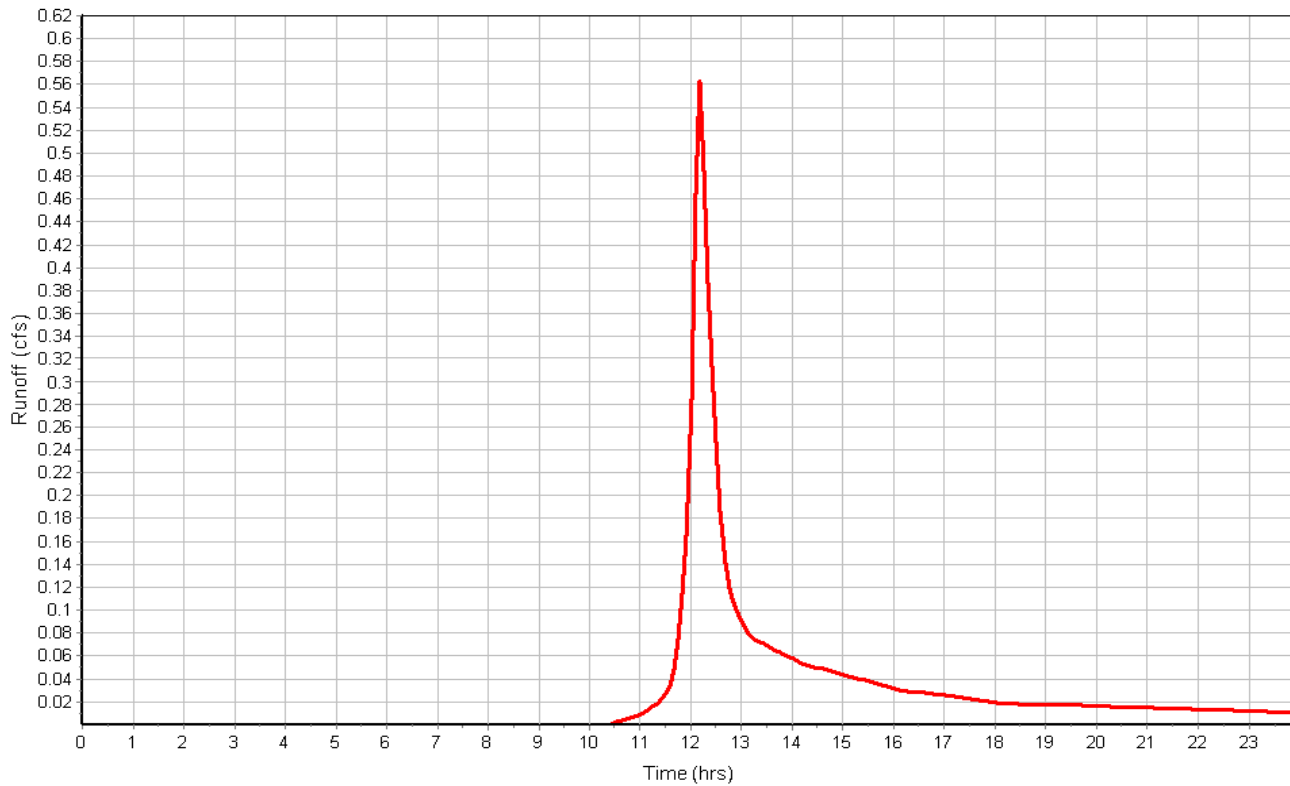

**Subbasin : E**

**Input Data**

Area (ac) ..... 2.86  
 Weighted Curve Number ..... 77.00  
 Rain Gage ID ..... Rain Gage-01

**Composite Curve Number**

Soil/Surface Description	Area (acres)	Soil Group	Curve Number
Woods, Good	2.86	D	77.00
Composite Area & Weighted CN	2.86		77.00

**Time of Concentration**

Sheet Flow Computations	Subarea	Subarea	Subarea
	A	B	C
Manning's Roughness :	.6	0.00	0.00
Flow Length (ft) :	100	0.00	0.00
Slope (%) :	24	0.00	0.00
2 yr, 24 hr Rainfall (in) :	3.00	0.00	0.00
Velocity (ft/sec) :	0.15	0.00	0.00
Computed Flow Time (min) :	11.35	0.00	0.00

Shallow Concentrated Flow Computations	Subarea	Subarea	Subarea
	A	B	C
Flow Length (ft) :	227	0.00	0.00
Slope (%) :	18	0.00	0.00
Surface Type :	Woodland	Unpaved	Unpaved
Velocity (ft/sec) :	2.12	0.00	0.00
Computed Flow Time (min) :	1.78	0.00	0.00
Total TOC (min) .....	13.14		

**Subbasin Runoff Results**

Total Rainfall (in) ..... 3.00  
 Total Runoff (in) ..... 1.07  
 Peak Runoff (cfs) ..... 2.68  
 Weighted Curve Number ..... 77.00  
 Time of Concentration (days hh:mm:ss) ..... 0 00:13:08

Subbasin : E

Rainfall Intensity Graph

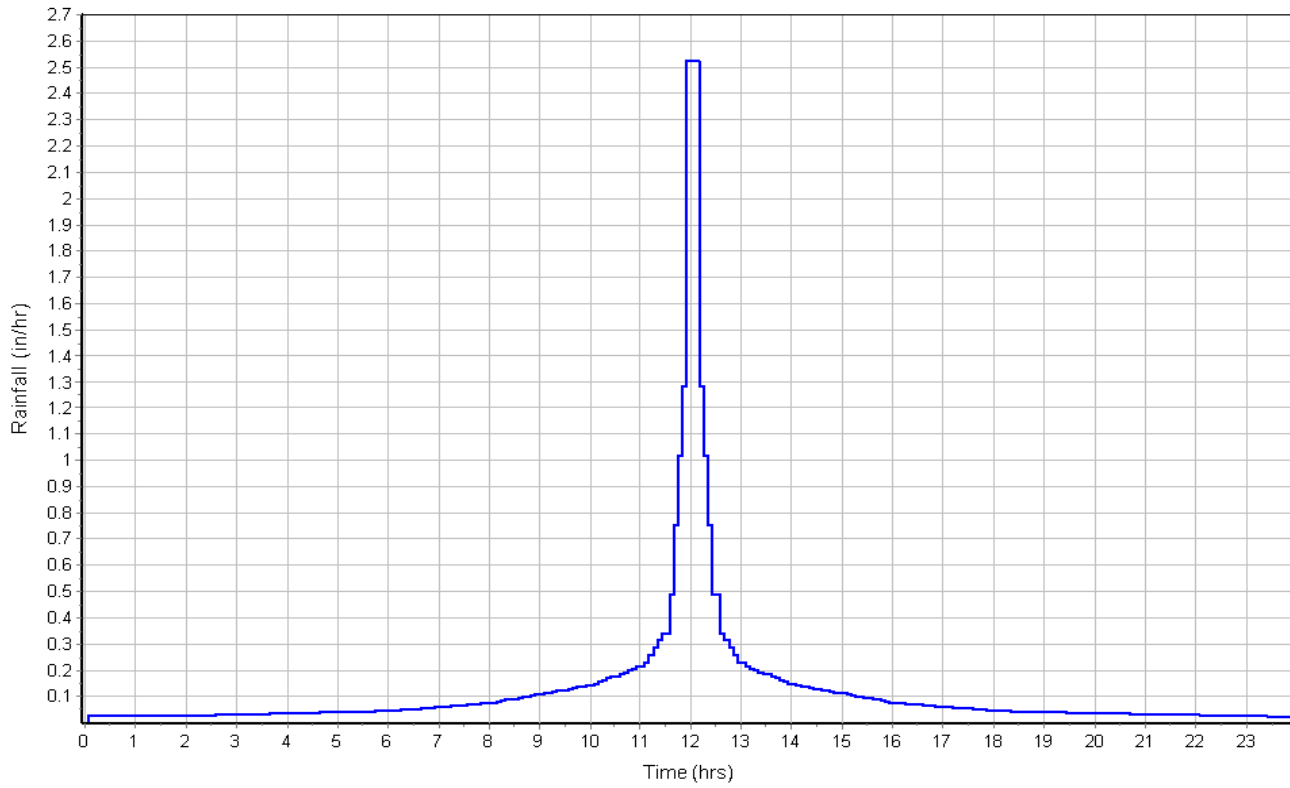

Runoff Hydrograph

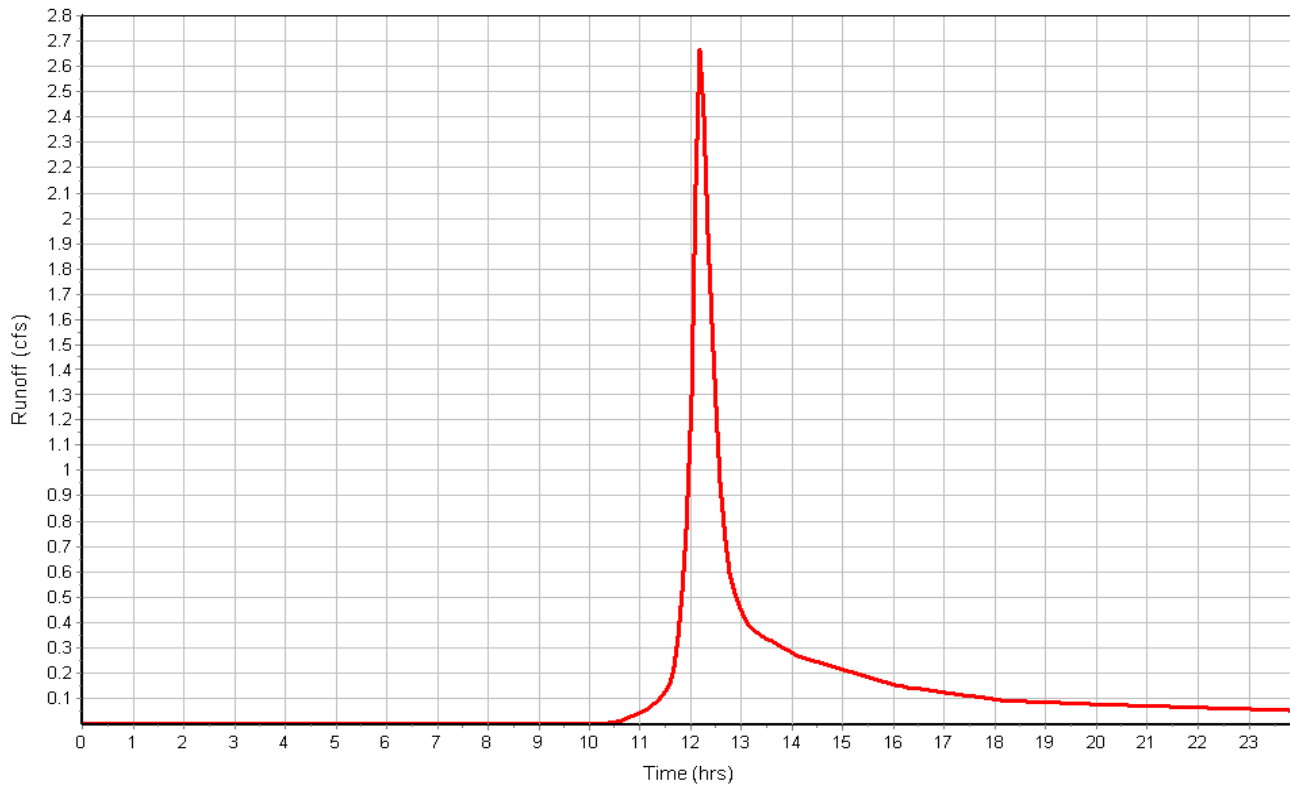

## Junction Input

Element ID	Invert Elevation (ft)	Ground/Rim (Max) Elevation (ft)
CB1	305.30	310.33
CB2	312.00	316.00
OUTLET-STR-A2	305.60	312.00
OUTLET-STR-C2	299.00	305.00

## Junction Results

Element ID	Peak Inflow	Max HGL Elevation Attained	Max HGL Depth Attained	Min Freeboard Attained	Average HGL Elevation Attained	Time of Max HGL Occurrence
	(cfs)	(ft)	(ft)	(ft)	(ft)	(days hh:mm)
CB1	6.96	306.39	1.09	3.94	305.49	0 12:26
CB2	7.78	312.73	0.73	3.27	312.10	0 12:15
OUTLET-STR-A2	5.15	306.37	0.77	5.63	305.73	0 12:26
OUTLET-STR-C2	0.00	299.00	0.00	6.00	299.00	0 00:00

## Pipe Input

Element ID	Length (ft)	Inlet Invert Elevation (ft)	Outlet Invert Elevation (ft)	Average Pipe Slope (%)	Pipe Shape	Pipe Diameter or Height (in)	Pipe Width (in)	Manning's Roughness
CULV-A	98.00	305.30	305.12	0.1800	CIRCULAR	36.000	36.000	0.0150
CULV-A2-1	104.00	312.00	310.00	1.9200	CIRCULAR	24.000	24.000	0.0150
CULV-A2-2	43.00	305.60	305.30	0.7000	CIRCULAR	24.000	24.000	0.0150
CULV-C2	40.00	299.00	298.00	2.5000	CIRCULAR	15.000	15.000	0.0150

## Pipe Results

Element ID	Peak Flow	Time of Peak Flow Occurrence	Design Flow Capacity	Peak Flow Velocity	Peak Flow Depth
	(cfs)	(days hh:mm)	(cfs)	(ft/sec)	(ft)
CULV-A	6.96	0 12:26	24.77	3.01	1.09
CULV-A2-1	7.73	0 12:15	27.19	7.47	0.73
CULV-A2-2	5.15	0 12:26	16.38	4.61	0.77
CULV-C2	0.00	0 00:00	8.85	0.00	0.00

## Storage Nodes

### Storage Node : DETENTION-A

#### Input Data

Invert Elevation (ft) ..... 309.50  
Max (Rim) Elevation (ft) ..... 312.00  
Max (Rim) Offset (ft) ..... 2.50  
Initial Water Elevation (ft) ..... 309.50  
Initial Water Depth (ft) ..... 0.00  
Ponded Area (ft<sup>2</sup>) ..... 0.00  
Evaporation Loss ..... 0.00

#### Storage Area Volume Curves

Storage Curve : Storage-08

Stage (ft)	Storage Area (ft <sup>2</sup> )	Storage Volume (ft <sup>3</sup> )
0	113	0.000
.5	15327	3860.00
1.2	18183.	15588.50
1.5	18635	21111.20
2.5	22257	41557.20



### Storage Area Volume Curves

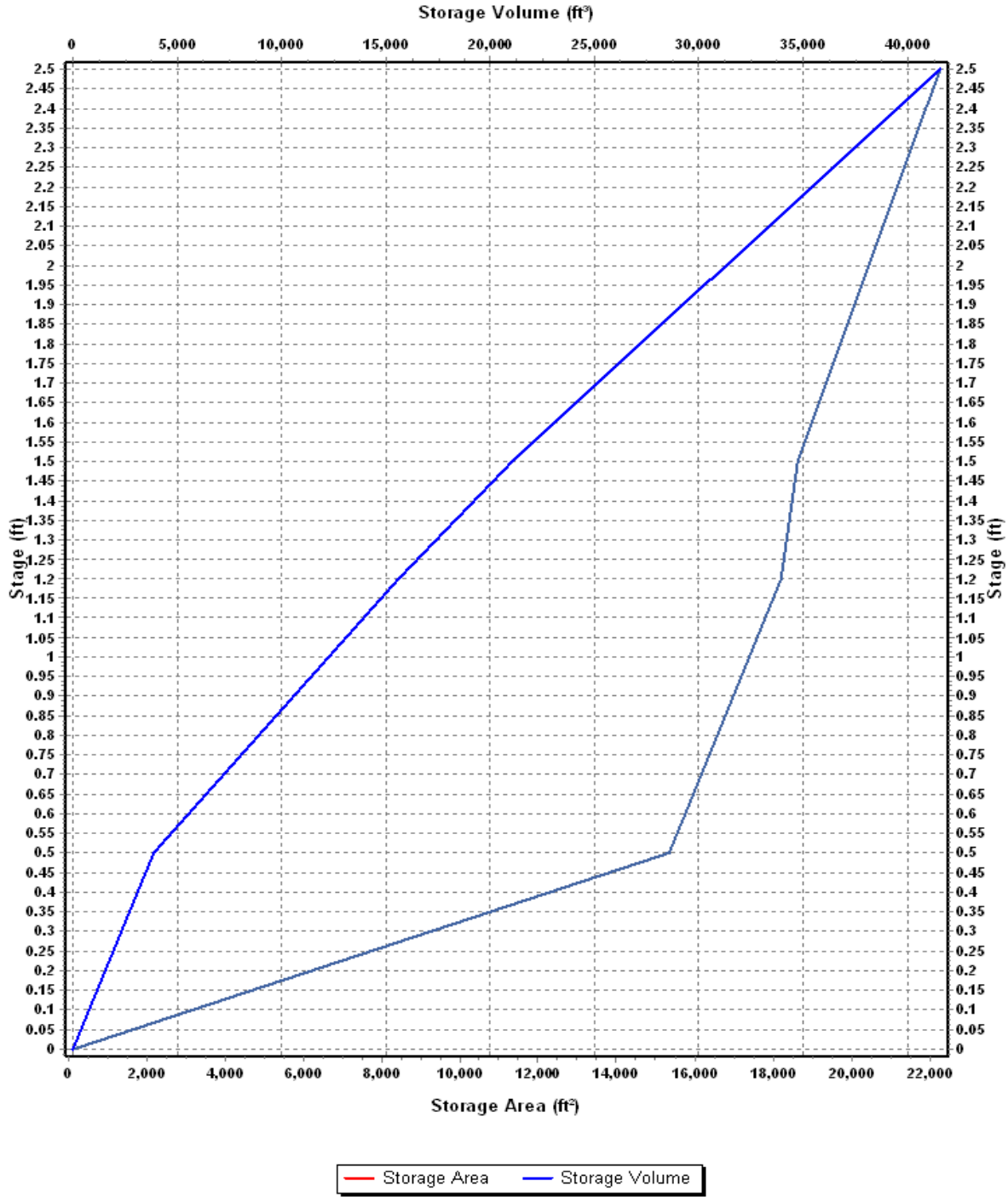

**Storage Node : DETENTION-A (continued)**

**Outflow Orifices**

Element ID	Orifice Type	Orifice Shape	Circular Orifice Diameter (in)	Rectangular Orifice Height (in)	Rectangular Orifice Width (in)	Orifice Invert Elevation (ft)	Orifice Coefficient
BEEHIVE-GRATE	Bottom	CIRCULAR	18.17			310.33	0.61
ORIF-DET-A	Side	Rectangular		4.00	36.00	309.50	0.63

**Output Summary Results**

Peak Inflow (cfs) .....	2.85
Peak Lateral Inflow (cfs) .....	2.85
Peak Outflow (cfs) .....	1.81
Peak Exfiltration Flow Rate (cfm) .....	0.00
Max HGL Elevation Attained (ft) .....	309.81
Max HGL Depth Attained (ft) .....	0.31
Average HGL Elevation Attained (ft) .....	309.54
Average HGL Depth Attained (ft) .....	0.04
Time of Max HGL Occurrence (days hh:mm) .....	0 12:25
Total Exfiltration Volume (1000-ft <sup>3</sup> ) .....	0.000
Total Flooded Volume (ac-in) .....	0
Total Time Flooded (min) .....	0
Total Retention Time (sec) .....	0.00

**Storage Node : FILTER-A2**

**Input Data**

Invert Elevation (ft) .....	308.00
Max (Rim) Elevation (ft) .....	312.00
Max (Rim) Offset (ft) .....	4.00
Initial Water Elevation (ft) .....	309.50
Initial Water Depth (ft) .....	1.50
Ponded Area (ft <sup>2</sup> ) .....	0.00
Evaporation Loss .....	0.00

**Storage Area Volume Curves**

Storage Curve : Storage-05

Stage (ft)	Storage Area (ft <sup>2</sup> )	Storage Volume (ft <sup>3</sup> )
0	2178	0.000
1	4172	3175.00
2	5127	7824.50
3	6050	13413.00
4	7075	19975.50

### Storage Area Volume Curves

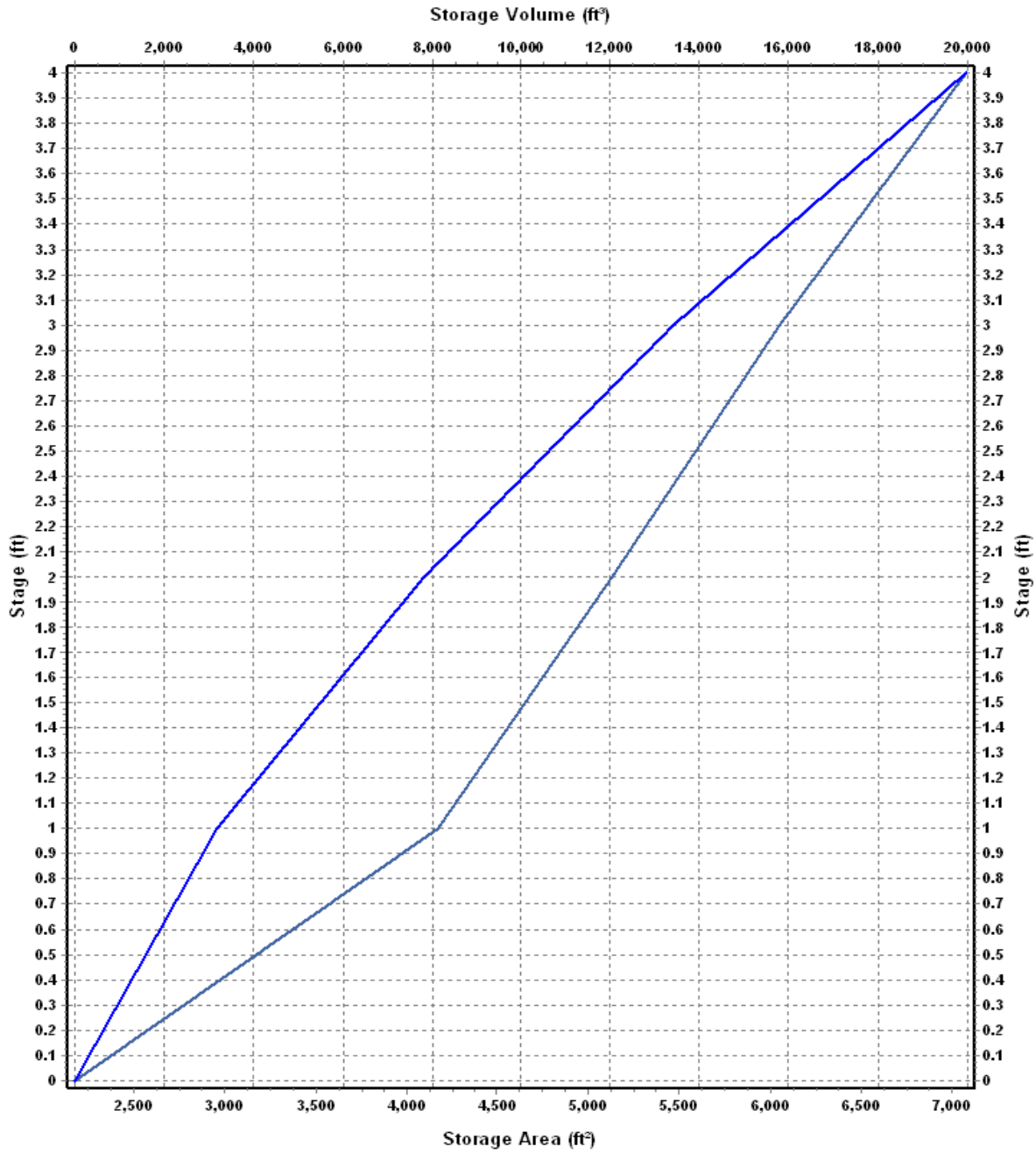

— Storage Area    — Storage Volume

**Storage Node : FILTER-A2 (continued)**

**Outflow Weirs**

Element ID	Weir Type	Crest Elevation (ft)	Length (ft)	Weir Total Height (ft)	Discharge Coefficient
SPILLWAY-A2	Trapezoidal	310.70	40.00	1.30	3.10

**Outflow Orifices**

Element ID	Orifice Type	Orifice Shape	Circular Orifice Diameter (in)	Rectangular Orifice Height (in)	Rectangular Orifice Width (in)	Orifice Invert Elevation (ft)	Orifice Coefficient
ORIF-A2	Side	Rectangular		6.00	30.00	309.50	0.63

**Output Summary Results**

Peak Inflow (cfs)	7.73
Peak Lateral Inflow (cfs)	0.00
Peak Outflow (cfs)	5.15
Peak Exfiltration Flow Rate (cfm)	0.00
Max HGL Elevation Attained (ft)	310.42
Max HGL Depth Attained (ft)	2.42
Average HGL Elevation Attained (ft)	309.59
Average HGL Depth Attained (ft)	1.59
Time of Max HGL Occurrence (days hh:mm)	0 12:26
Total Exfiltration Volume (1000-ft <sup>3</sup> )	0.000
Total Flooded Volume (ac-in)	0
Total Time Flooded (min)	0
Total Retention Time (sec)	0.00

**Storage Node : FILTER-C2**

**Input Data**

Invert Elevation (ft) ..... 301.50  
Max (Rim) Elevation (ft) ..... 305.00  
Max (Rim) Offset (ft) ..... 3.50  
Initial Water Elevation (ft) ..... 301.75  
Initial Water Depth (ft) ..... 0.25  
Ponded Area (ft<sup>2</sup>) ..... 0.00  
Evaporation Loss ..... 0.00

**Storage Area Volume Curves**

Storage Curve : Storage-07

Stage (ft)	Storage Area (ft <sup>2</sup> )	Storage Volume (ft <sup>3</sup> )
0	3380	0.000
.5	6601	2495.25
1.5	8462	10026.75
2.5	10125	19320.25
3.5	11092	29928.75

### Storage Area Volume Curves

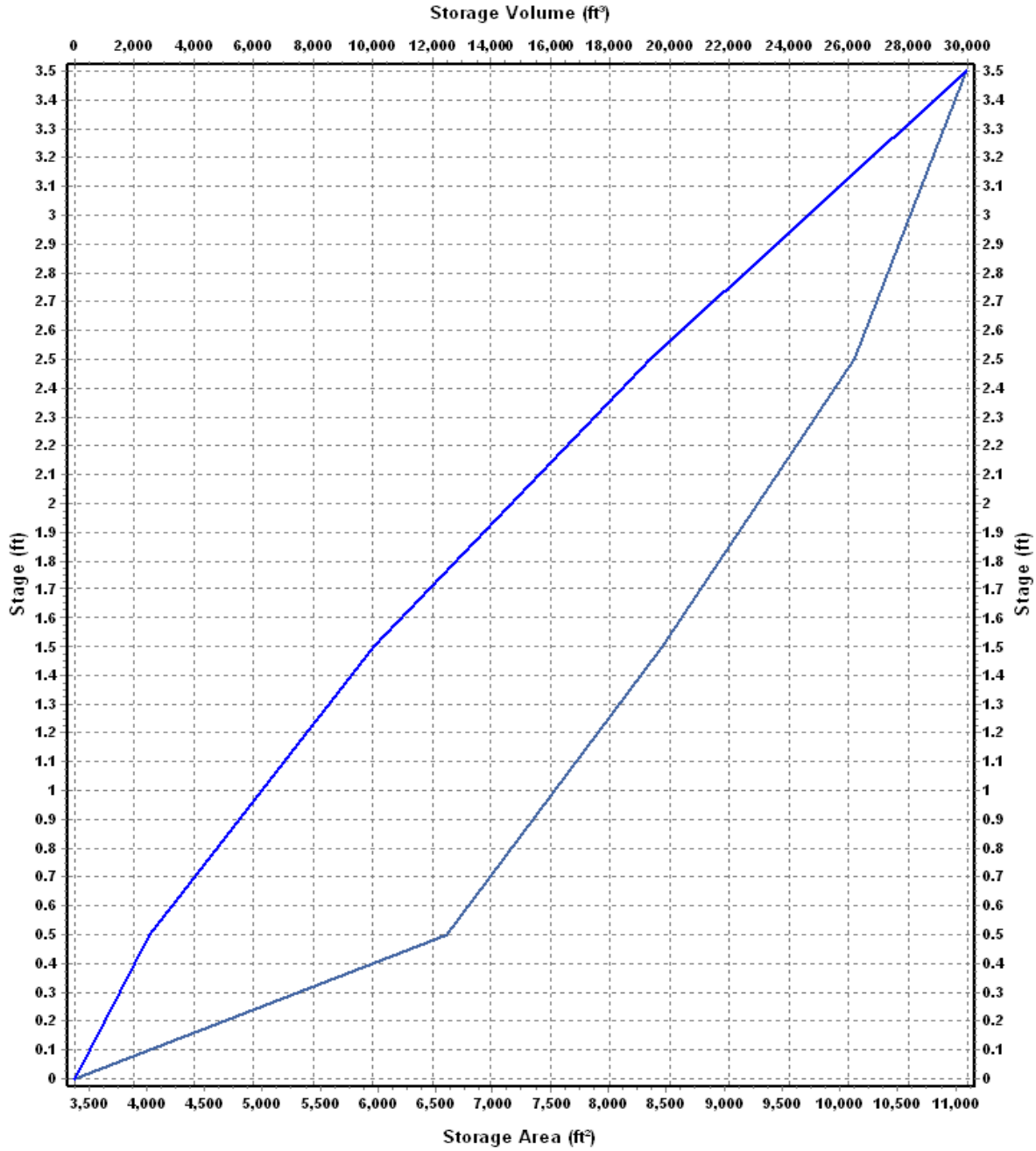

— Storage Area — Storage Volume

**Storage Node : FILTER-C2 (continued)**

**Outflow Weirs**

Element ID	Weir Type	Crest Elevation (ft)	Length (ft)	Weir Total Height (ft)	Discharge Coefficient
SPILLWAY-C2	Trapezoidal	303.80	30.00	1.20	3.10

**Outflow Orifices**

Element ID	Orifice Type	Orifice Shape	Circular Orifice Diameter (in)	Rectangular Orifice Height (in)	Rectangular Orifice Width (in)	Orifice Invert Elevation (ft)	Orifice Coefficient
ORIF-C2	Side	CIRCULAR	4.00			303.25	0.61

**Output Summary Results**

Peak Inflow (cfs)	2.24
Peak Lateral Inflow (cfs)	2.24
Peak Outflow (cfs)	0.00
Peak Exfiltration Flow Rate (cfm)	0.00
Max HGL Elevation Attained (ft)	303.20
Max HGL Depth Attained (ft)	1.7
Average HGL Elevation Attained (ft)	302.36
Average HGL Depth Attained (ft)	0.86
Time of Max HGL Occurrence (days hh:mm)	1 00:00
Total Exfiltration Volume (1000-ft <sup>3</sup> )	0.000
Total Flooded Volume (ac-in)	0
Total Time Flooded (min)	0
Total Retention Time (sec)	0.00



## Project Description

File Name ..... Proposed Conditions 5-30-18.SPF

## Project Options

Flow Units ..... CFS  
 Elevation Type ..... Elevation  
 Hydrology Method ..... SCS TR-55  
 Time of Concentration (TOC) Method ..... SCS TR-55  
 Link Routing Method ..... Kinematic Wave  
 Enable Overflow Ponding at Nodes ..... YES  
 Skip Steady State Analysis Time Periods ..... NO

## Analysis Options

Start Analysis On ..... Jul 13, 2017 00:00:00  
 End Analysis On ..... Jul 14, 2017 00:00:00  
 Start Reporting On ..... Jul 13, 2017 00:00:00  
 Antecedent Dry Days ..... 0 days  
 Runoff (Dry Weather) Time Step ..... 0 01:00:00 days hh:mm:ss  
 Runoff (Wet Weather) Time Step ..... 0 00:05:00 days hh:mm:ss  
 Reporting Time Step ..... 0 00:05:00 days hh:mm:ss  
 Routing Time Step ..... 30 seconds

## Number of Elements

Qty  
 Rain Gages ..... 1  
 Subbasins..... 8  
 Nodes..... 12  
     *Junctions* ..... 4  
     *Outfalls* ..... 5  
     *Flow Diversions* ..... 0  
     *Inlets* ..... 0  
     *Storage Nodes* ..... 3  
 Links..... 10  
     *Channels* ..... 0  
     *Pipes* ..... 4  
     *Pumps* ..... 0  
     *Orifices* ..... 4  
     *Weirs* ..... 2  
     *Outlets* ..... 0  
 Pollutants ..... 0  
 Land Uses ..... 0

## Rainfall Details

SN	Rain Gage ID	Data Source	Data Source ID	Rainfall Type	Rain Units	State	County	Return Period (years)	Rainfall Depth (inches)	Rainfall Distribution
1	Rain Gage-01	Time Series	TS-10	Cumulative	inches	Maine	Androscoggin	10	4.60	SCS Type III 24-hr

## Subbasin Summary

Subbasin ID	Area (ac)	Weighted Curve Number	Total Rainfall (in)	Total Runoff (in)	Total Runoff Volume (ac-in)	Peak Runoff (cfs)	Time of Concentration (days hh:mm:ss)
A1	12.28	73.16	4.60	1.98	24.36	12.68	0 00:49:44
A2	6.41	81.47	4.60	2.68	17.15	15.58	0 00:12:48
A3	4.01	71.75	4.60	1.88	7.52	7.30	0 00:09:08
B	4.99	75.82	4.60	2.20	10.95	7.98	0 00:24:28
C1	15.70	73.25	4.60	1.99	31.26	14.63	0 00:59:49
C2	2.05	82.98	4.60	2.81	5.77	4.39	0 00:22:00
D	0.59	77.00	4.60	2.29	1.35	1.24	0 00:12:07
E	2.86	77.00	4.60	2.29	6.56	5.91	0 00:13:08

## Node Summary

Element ID	Element Type	Invert Elevation
		(ft)
CB1	Junction	305.30
CB2	Junction	312.00
OUTLET-STR-A2	Junction	305.60
OUTLET-STR-C2	Junction	299.00
OUT-A	Outfall	298.00
OUT-B	Outfall	310.00
OUT-C	Outfall	298.00
OUT-D	Outfall	338.00
OUT-E	Outfall	298.00
DETENTION-A	Storage Node	309.50
FILTER-A2	Storage Node	308.00
FILTER-C2	Storage Node	301.50

## Link Summary

Element ID	Element Type	From (Inlet) Node	To (Outlet) Node	Length	Inlet Invert Elevation	Outlet Invert Elevation	Average Slope	Diameter or Height	Manning's Roughness	Peak Flow	Design Flow Capacity	Peak Flow Velocity	Peak Flow Depth
				(ft)	(ft)	(ft)	(%)	(in)		(cfs)	(cfs)	(ft/sec)	(ft)
CULV-A	Pipe	CB1	OUT-A	98.00	305.30	305.12	0.1800	36.000	0.0150	11.11	24.77	3.41	1.41
CULV-A2-1	Pipe	CB2	FILTER-A2	104.00	312.00	310.00	1.9200	24.000	0.0150	15.49	27.19	8.95	1.08
CULV-A2-2	Pipe	OUTLET-STR-A2	CB1	43.00	305.60	305.30	0.7000	24.000	0.0150	6.63	16.38	4.94	0.88
CULV-C2	Pipe	OUTLET-STR-C2	OUT-C	40.00	299.00	298.00	2.5000	15.000	0.0150	0.22	8.85	2.94	0.14
BEEHIVE-GRATE	Orifice	DETENTION-A	CB1		309.50	305.30		18.167		0.43			
ORIF-A2	Orifice	FILTER-A2	OUTLET-STR-A2		308.00	305.60		6.000		6.63			
ORIF-C2	Orifice	FILTER-C2	OUTLET-STR-C2		301.50	299.00		4.000		0.22			
ORIF-DET-A	Orifice	DETENTION-A	CB1		309.50	305.30		4.000		4.36			
SPILLWAY-A2	Weir	FILTER-A2	DETENTION-A		308.00	309.50				8.27			
SPILLWAY-C2	Weir	FILTER-C2	OUT-C		301.50	298.00				0.00			

## Subbasin Hydrology

### Subbasin : A1

#### Input Data

Area (ac) ..... 12.28  
Weighted Curve Number ..... 73.16  
Rain Gage ID ..... Rain Gage-01

#### Composite Curve Number

Soil/Surface Description	Area (acres)	Soil Group	Curve Number
Woods, Good	4.58	D	77.00
> 75% grass cover, Good	0.68	C	74.00
Woods, Good	6.62	C	70.00
> 75% grass cover, Good	0.40	D	80.00
Composite Area & Weighted CN	12.28		73.16

#### Time of Concentration

TOC Method : SCS TR-55

Sheet Flow Equation :

$$T_c = (0.007 * ((n * L_f)^{0.8})) / ((P^{0.5}) * (S_f^{0.4}))$$

Where :

T<sub>c</sub> = Time of Concentration (hr)  
n = Manning's roughness  
L<sub>f</sub> = Flow Length (ft)  
P = 2 yr, 24 hr Rainfall (inches)  
S<sub>f</sub> = Slope (ft/ft)

Shallow Concentrated Flow Equation :

V = 16.1345 \* (S<sub>f</sub><sup>0.5</sup>) (unpaved surface)  
V = 20.3282 \* (S<sub>f</sub><sup>0.5</sup>) (paved surface)  
V = 15.0 \* (S<sub>f</sub><sup>0.5</sup>) (grassed waterway surface)  
V = 10.0 \* (S<sub>f</sub><sup>0.5</sup>) (nearly bare & untilled surface)  
V = 9.0 \* (S<sub>f</sub><sup>0.5</sup>) (cultivated straight rows surface)  
V = 7.0 \* (S<sub>f</sub><sup>0.5</sup>) (short grass pasture surface)  
V = 5.0 \* (S<sub>f</sub><sup>0.5</sup>) (woodland surface)  
V = 2.5 \* (S<sub>f</sub><sup>0.5</sup>) (forest w/heavy litter surface)  
T<sub>c</sub> = (L<sub>f</sub> / V) / (3600 sec/hr)

Where:

T<sub>c</sub> = Time of Concentration (hr)  
L<sub>f</sub> = Flow Length (ft)  
V = Velocity (ft/sec)  
S<sub>f</sub> = Slope (ft/ft)

Channel Flow Equation :

$$V = (1.49 * (R^{2/3})) * (S_f^{0.5}) / n$$

R = A<sub>q</sub> / W<sub>p</sub>  
T<sub>c</sub> = (L<sub>f</sub> / V) / (3600 sec/hr)

Where :

T<sub>c</sub> = Time of Concentration (hr)  
L<sub>f</sub> = Flow Length (ft)  
R = Hydraulic Radius (ft)  
A<sub>q</sub> = Flow Area (ft<sup>2</sup>)  
W<sub>p</sub> = Wetted Perimeter (ft)  
V = Velocity (ft/sec)  
S<sub>f</sub> = Slope (ft/ft)  
n = Manning's roughness

	Subarea	Subarea	Subarea
	A	B	C
<b>Sheet Flow Computations</b>			
Manning's Roughness :	.6	0.00	0.00
Flow Length (ft) :	100	0.00	0.00
Slope (%) :	2	0.00	0.00
2 yr, 24 hr Rainfall (in) :	3.00	0.00	0.00
Velocity (ft/sec) :	0.05	0.00	0.00
Computed Flow Time (min) :	30.68	0.00	0.00
<b>Shallow Concentrated Flow Computations</b>			
	Subarea	Subarea	Subarea
	A	B	C
Flow Length (ft) :	1510	0.00	0.00
Slope (%) :	.78	0.00	0.00
Surface Type :		Unpaved	Unpaved
Velocity (ft/sec) :	1.32	0.00	0.00
Computed Flow Time (min) :	19.07	0.00	0.00
Total TOC (min) .....	49.74		

**Subbasin Runoff Results**

Total Rainfall (in) .....	4.60
Total Runoff (in) .....	1.98
Peak Runoff (cfs) .....	12.68
Weighted Curve Number .....	73.16
Time of Concentration (days hh:mm:ss) .....	0 00:49:44

Subbasin : A1

Rainfall Intensity Graph

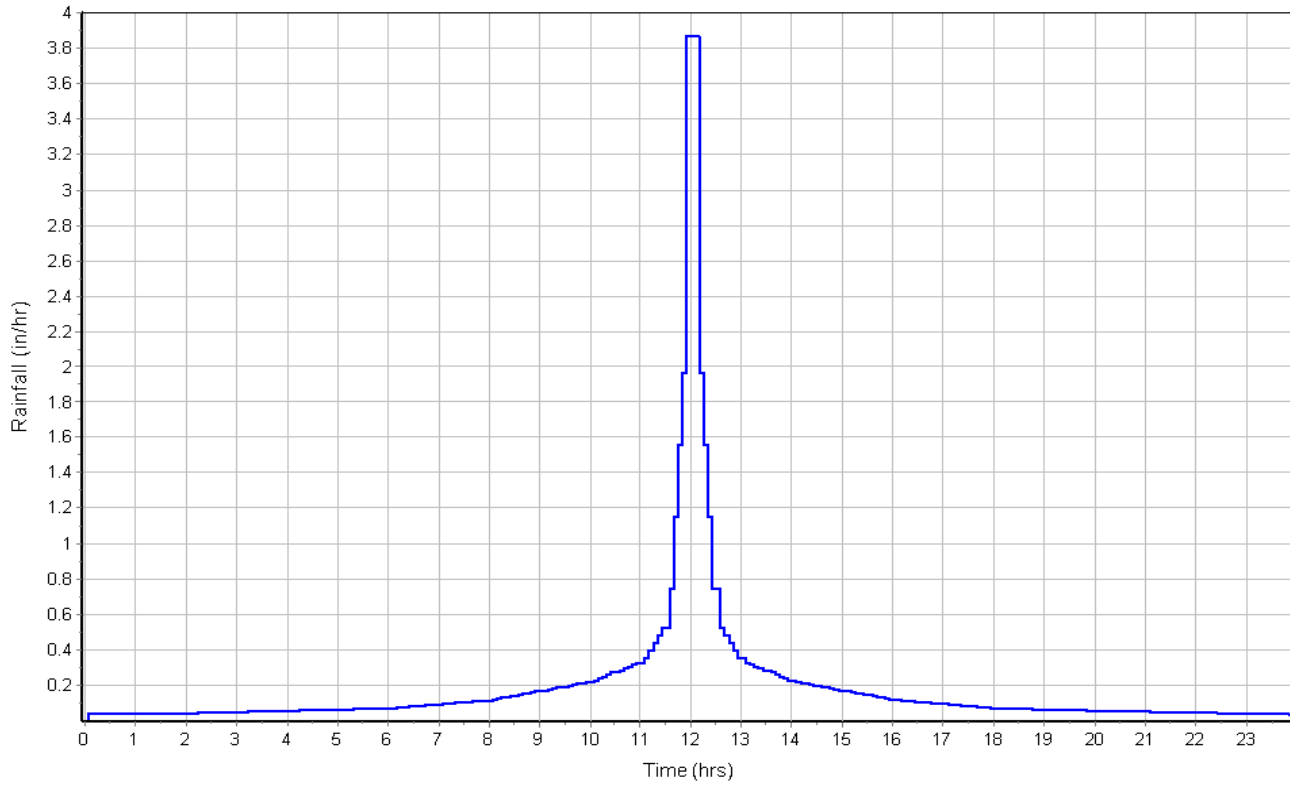

Runoff Hydrograph

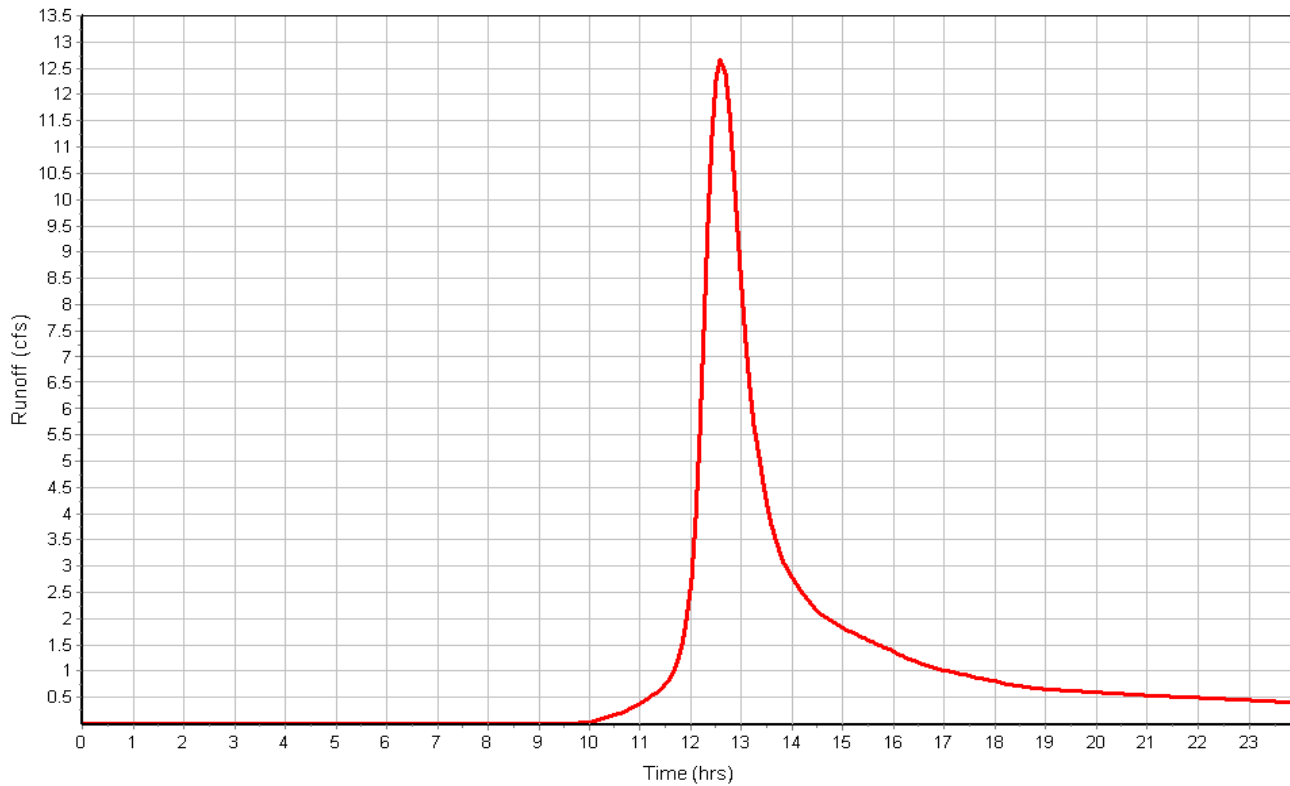

**Subbasin : A2**

**Input Data**

Area (ac) ..... 6.41  
 Weighted Curve Number ..... 81.47  
 Rain Gage ID ..... Rain Gage-01

**Composite Curve Number**

Soil/Surface Description	Area (acres)	Soil Group	Curve Number
Woods, Good	0.13	D	77.00
Roofs	1.77	D	98.00
> 75% grass cover, Good	1.87	D	80.00
Stone_Pad	1.80	D	60.00
Gravel roads	0.17	D	91.00
Pavement	0.67	D	98.00
Composite Area & Weighted CN	6.41		81.47

**Time of Concentration**

	Subarea		
	A	B	C
<b>Sheet Flow Computations</b>			
Manning's Roughness :	.4	0.00	0.00
Flow Length (ft) :	85	0.00	0.00
Slope (%) :	33.33	0.00	0.00
2 yr, 24 hr Rainfall (in) :	3.00	0.00	0.00
Velocity (ft/sec) :	0.22	0.00	0.00
Computed Flow Time (min) :	6.32	0.00	0.00
<b>Channel Flow Computations</b>			
Manning's Roughness :	.04	0.00	0.00
Flow Length (ft) :	1138	0.00	0.00
Channel Slope (%) :	1.4	0.00	0.00
Cross Section Area (ft <sup>2</sup> ) :	4.398	0.00	0.00
Wetted Perimeter (ft) :	8.12	0.00	0.00
Velocity (ft/sec) :	2.93	0.00	0.00
Computed Flow Time (min) :	6.48	0.00	0.00
Total TOC (min) .....	12.80		

**Subbasin Runoff Results**

Total Rainfall (in) ..... 4.60  
 Total Runoff (in) ..... 2.68  
 Peak Runoff (cfs) ..... 15.58  
 Weighted Curve Number ..... 81.47  
 Time of Concentration (days hh:mm:ss) ..... 0 00:12:48



Subbasin : A2

Rainfall Intensity Graph

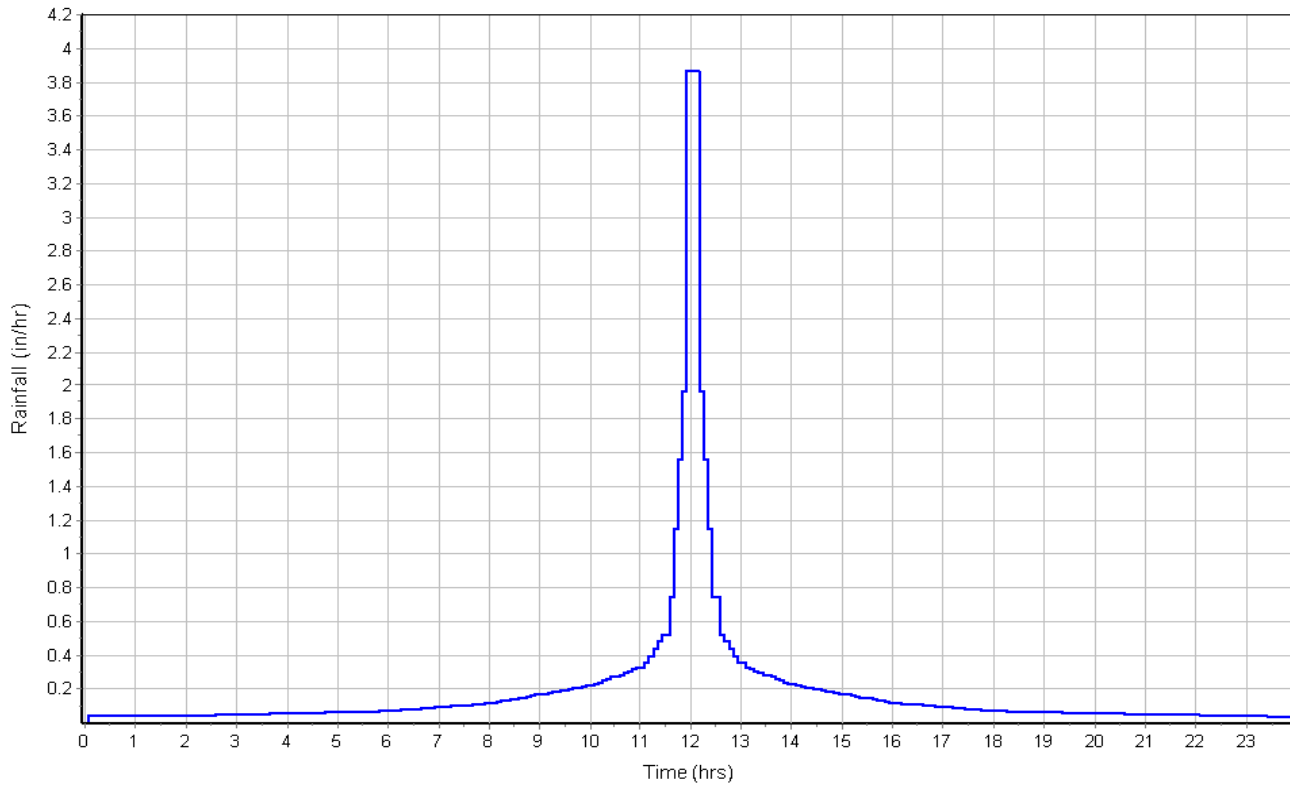

Runoff Hydrograph

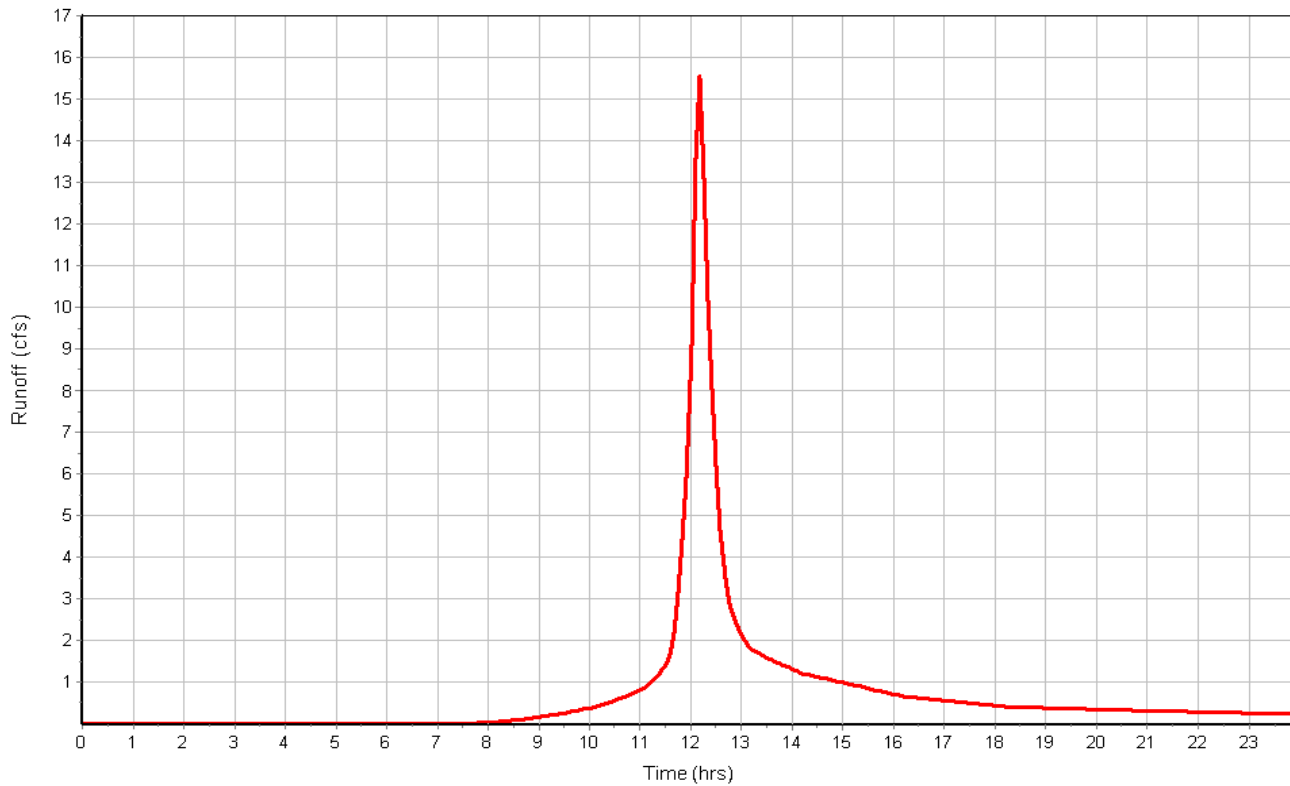

**Subbasin : A3**

**Input Data**

Area (ac) ..... 4.01  
 Weighted Curve Number ..... 71.75  
 Rain Gage ID ..... Rain Gage-01

**Composite Curve Number**

Soil/Surface Description	Area (acres)	Soil Group	Curve Number
> 75% grass cover, Good	0.75	D	80.00
> 75% grass cover, Good	0.14	C	74.00
Stone_Pad	2.28	D	60.00
Roofs	0.19	D	98.00
Gravel roads	0.25	D	91.00
Pavement	0.35	D	98.00
Foundations	0.05	D	98.00
Composite Area & Weighted CN	4.01		71.75

**Time of Concentration**

Sheet Flow Computations	Subarea	Subarea	Subarea
	A	B	C
Manning's Roughness :	.01	0.00	0.00
Flow Length (ft) :	100	0.00	0.00
Slope (%) :	2	0.00	0.00
2 yr, 24 hr Rainfall (in) :	3.00	0.00	0.00
Velocity (ft/sec) :	1.44	0.00	0.00
Computed Flow Time (min) :	1.16	0.00	0.00

Shallow Concentrated Flow Computations	Subarea	Subarea	Subarea
	A	B	C
Flow Length (ft) :	548	25	200
Slope (%) :	2	33.33	1.5
Surface Type :	Unpaved		
Velocity (ft/sec) :	2.28	4.04	0.86
Computed Flow Time (min) :	4.01	0.10	3.88
Total TOC (min) .....9.14			

**Subbasin Runoff Results**

Total Rainfall (in) ..... 4.60  
 Total Runoff (in) ..... 1.88  
 Peak Runoff (cfs) ..... 7.30  
 Weighted Curve Number ..... 71.75  
 Time of Concentration (days hh:mm:ss) ..... 0 00:09:08

Subbasin : A3

Rainfall Intensity Graph

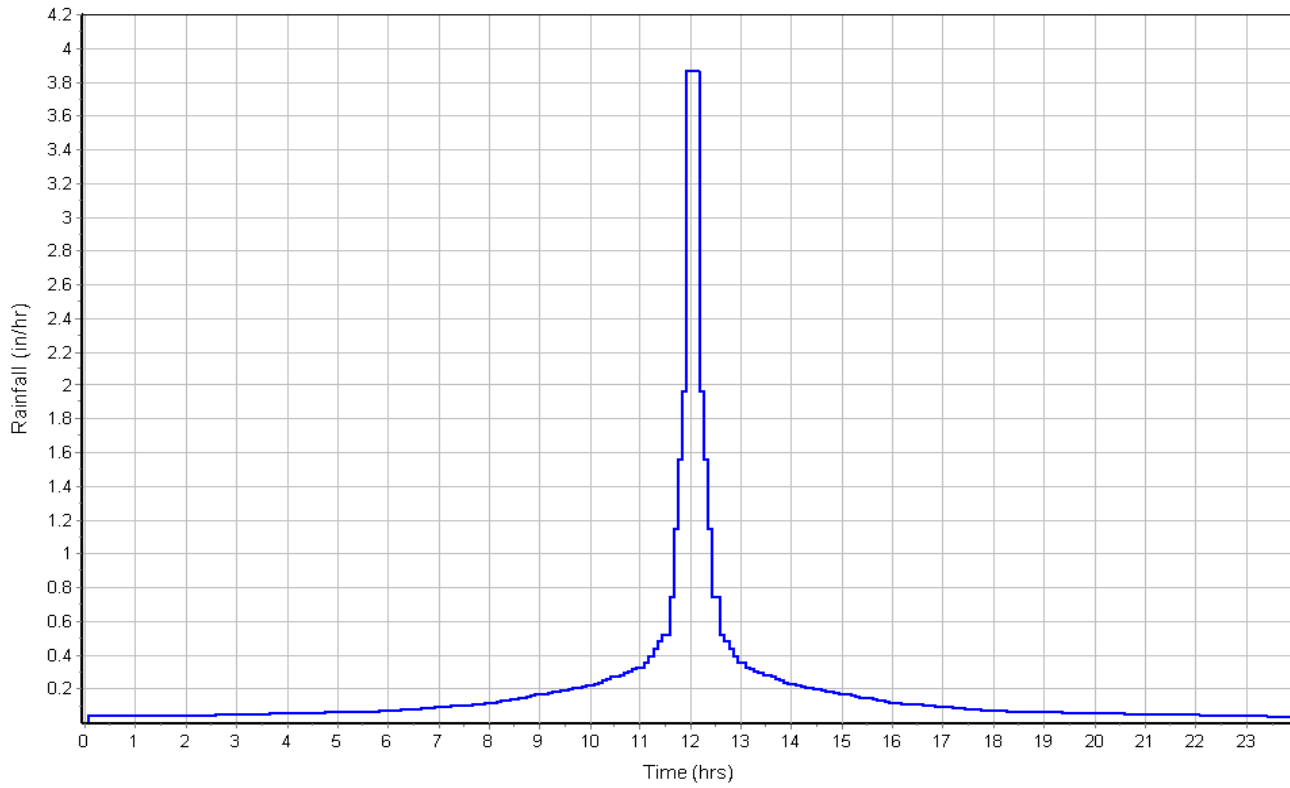

Runoff Hydrograph

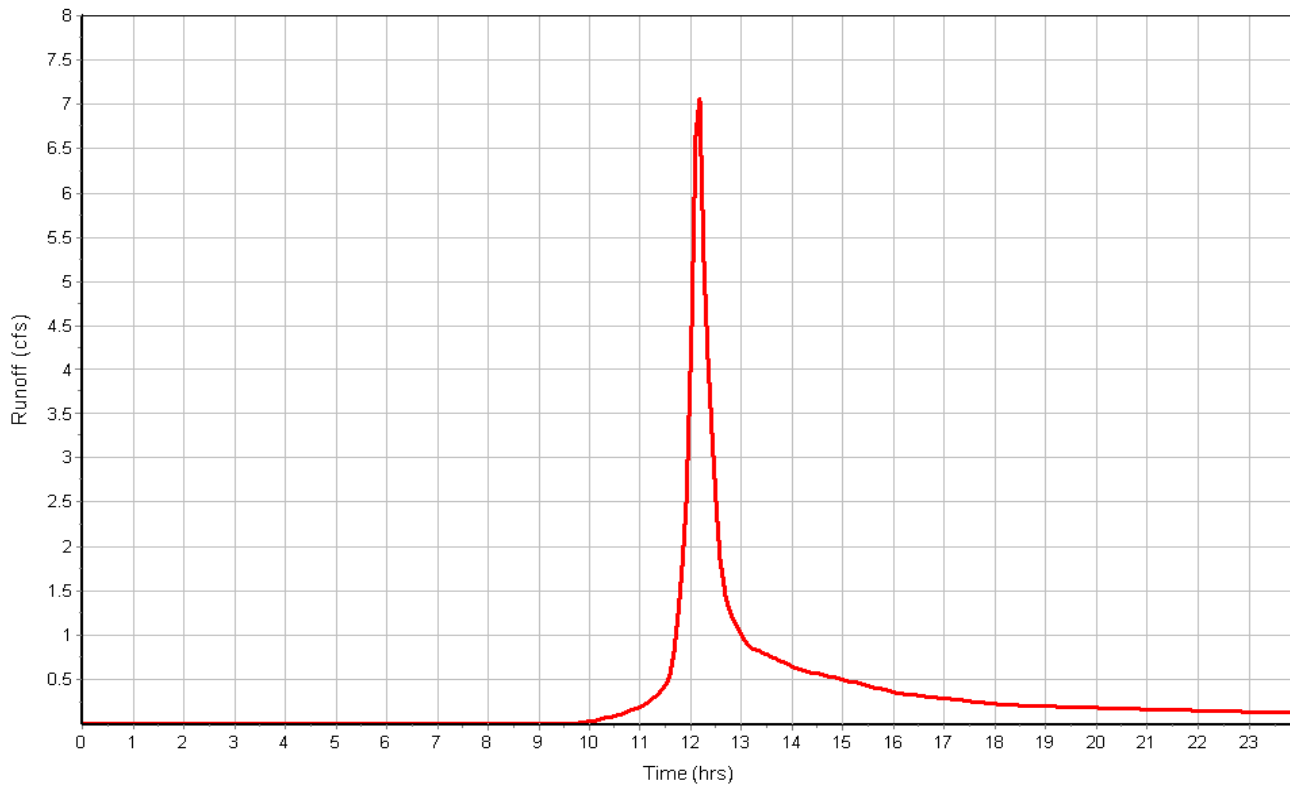

**Subbasin : B**

**Input Data**

Area (ac) ..... 4.99  
 Weighted Curve Number ..... 75.82  
 Rain Gage ID ..... Rain Gage-01

**Composite Curve Number**

Soil/Surface Description	Area (acres)	Soil Group	Curve Number
Woods, Good	1.05	C	70.00
Woods, Good	3.45	D	77.00
> 75% grass cover, Good	0.49	D	80.00
Composite Area & Weighted CN	4.99		75.82

**Time of Concentration**

	Subarea		
	A	B	C
<b>Sheet Flow Computations</b>			
Manning's Roughness :	.4	0.00	0.00
Flow Length (ft) :	90	0.00	0.00
Slope (%) :	33.33	0.00	0.00
2 yr, 24 hr Rainfall (in) :	3.00	0.00	0.00
Velocity (ft/sec) :	0.23	0.00	0.00
Computed Flow Time (min) :	6.62	0.00	0.00
<b>Shallow Concentrated Flow Computations</b>			
Flow Length (ft) :	368	0.00	0.00
Slope (%) :	1.63	0.00	0.00
Surface Type :		Unpaved	Unpaved
Velocity (ft/sec) :	1.92	0.00	0.00
Computed Flow Time (min) :	3.19	0.00	0.00
<b>Channel Flow Computations</b>			
Manning's Roughness :	.3	.3	0.00
Flow Length (ft) :	272	85	0.00
Channel Slope (%) :	1.4	16.7	0.00
Cross Section Area (ft²) :	3.287	1.367	0.00
Wetted Perimeter (ft) :	7.17	5.15	0.00
Velocity (ft/sec) :	0.35	0.84	0.00
Computed Flow Time (min) :	12.97	1.69	0.00
Total TOC (min) .....24.48			

**Subbasin Runoff Results**

Total Rainfall (in) ..... 4.60  
 Total Runoff (in) ..... 2.20  
 Peak Runoff (cfs) ..... 7.98  
 Weighted Curve Number ..... 75.82  
 Time of Concentration (days hh:mm:ss) ..... 0 00:24:29

**Subbasin : B**

**Rainfall Intensity Graph**

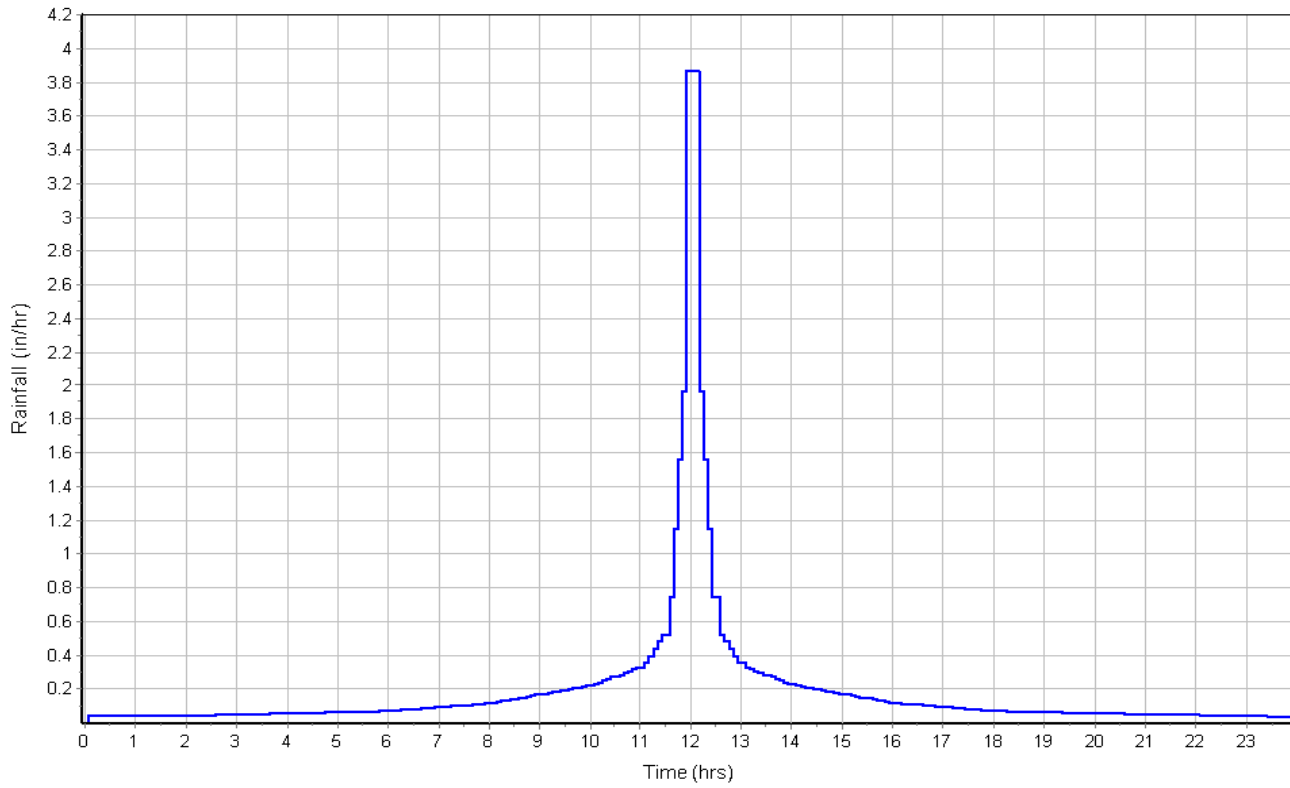

**Runoff Hydrograph**

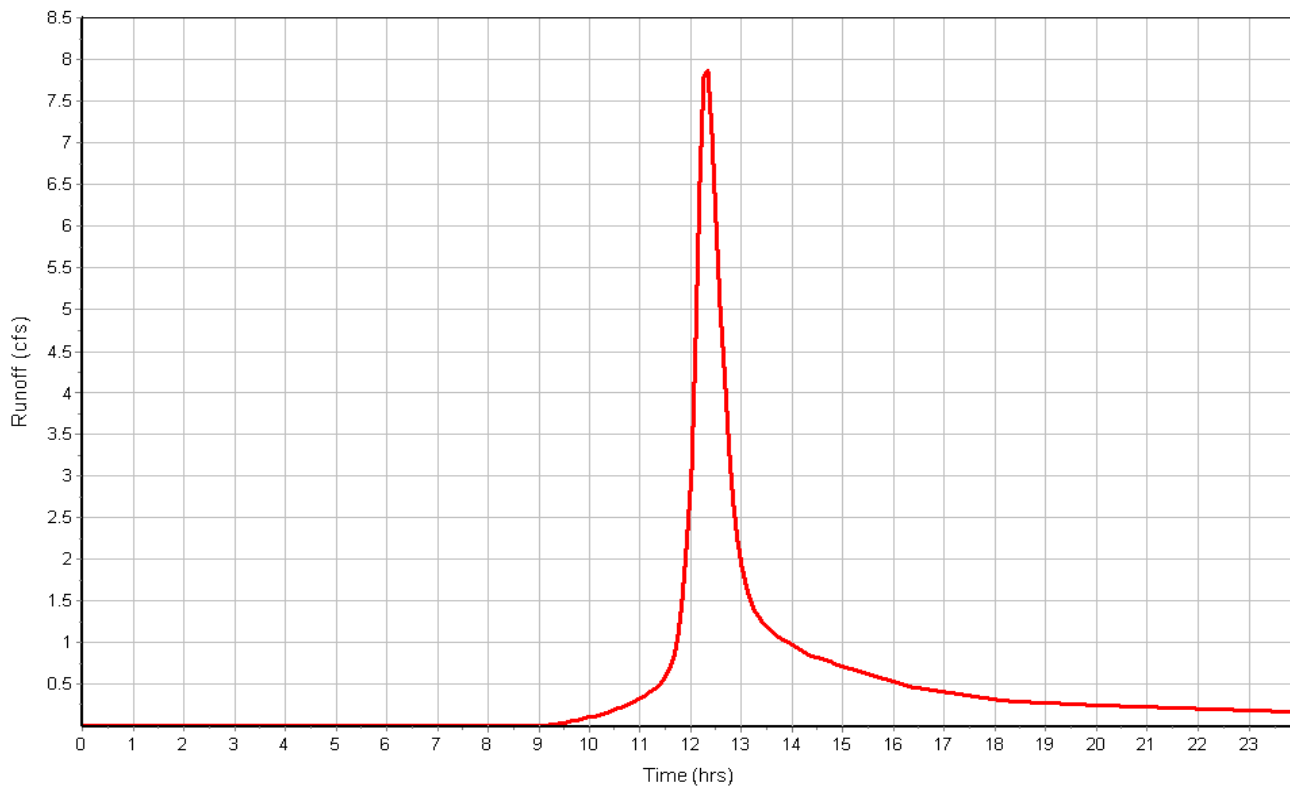

**Subbasin : C1**

**Input Data**

Area (ac) ..... 15.70  
 Weighted Curve Number ..... 73.25  
 Rain Gage ID ..... Rain Gage-01

**Composite Curve Number**

Soil/Surface Description	Area (acres)	Soil Group	Curve Number
Gravel roads	0.17	D	91.00
> 75% grass cover, Good	0.04	D	80.00
Woods, Good	8.63	C	70.00
Woods, Good	6.55	D	77.00
> 75% grass cover, Good	0.31	C	74.00
Composite Area & Weighted CN	15.70		73.25

**Time of Concentration**

Sheet Flow Computations	Subarea	Subarea	Subarea
	A	B	C
Manning's Roughness :	.6	0.00	0.00
Flow Length (ft) :	100	0.00	0.00
Slope (%) :	2	0.00	0.00
2 yr, 24 hr Rainfall (in) :	3.00	0.00	0.00
Velocity (ft/sec) :	0.05	0.00	0.00
Computed Flow Time (min) :	30.68	0.00	0.00
Shallow Concentrated Flow Computations	Subarea	Subarea	Subarea
	A	B	C
Flow Length (ft) :	1907	0.00	0.00
Slope (%) :	.524	0.00	0.00
Surface Type :		Unpaved	Unpaved
Velocity (ft/sec) :	1.09	0.00	0.00
Computed Flow Time (min) :	29.16	0.00	0.00
Total TOC (min) .....59.83			

**Subbasin Runoff Results**

Total Rainfall (in) ..... 4.60  
 Total Runoff (in) ..... 1.99  
 Peak Runoff (cfs) ..... 14.63  
 Weighted Curve Number ..... 73.25  
 Time of Concentration (days hh:mm:ss) ..... 0 00:59:50

Subbasin : C1

Rainfall Intensity Graph

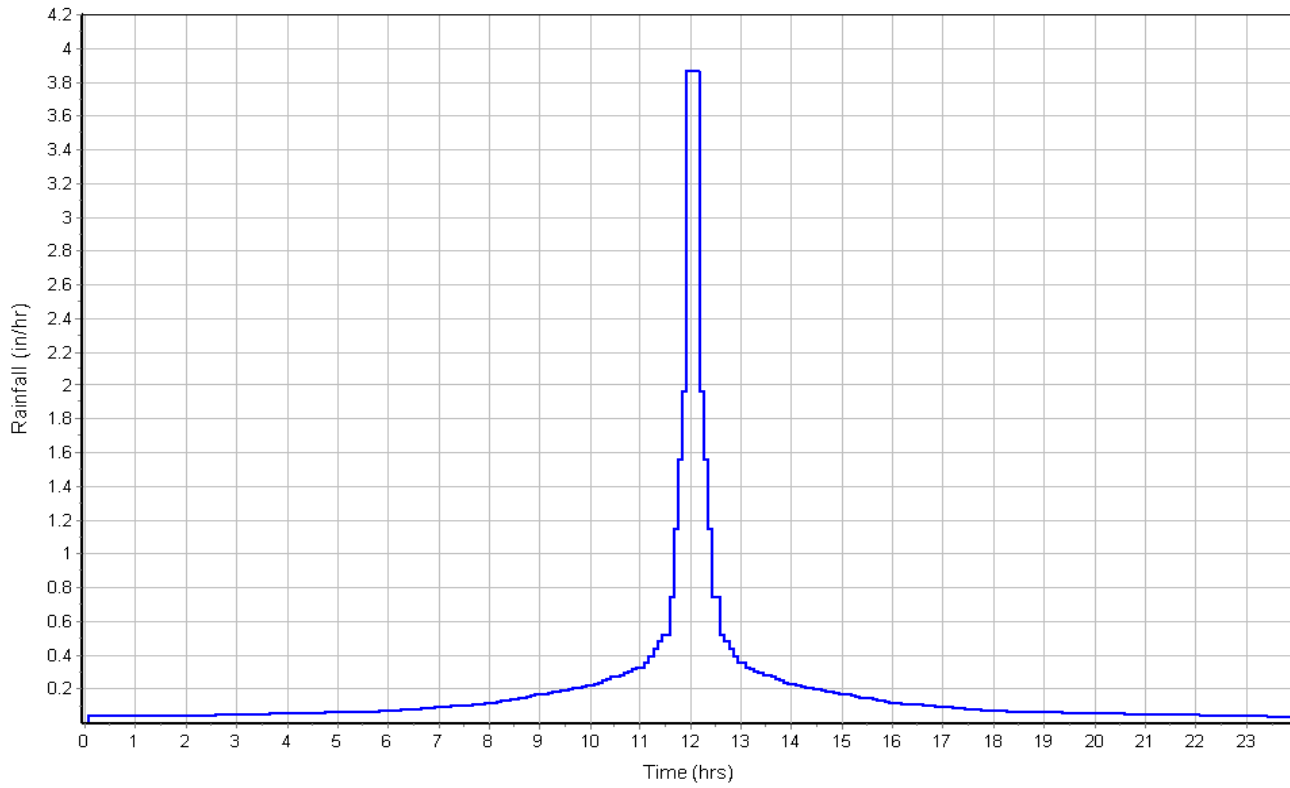

Runoff Hydrograph

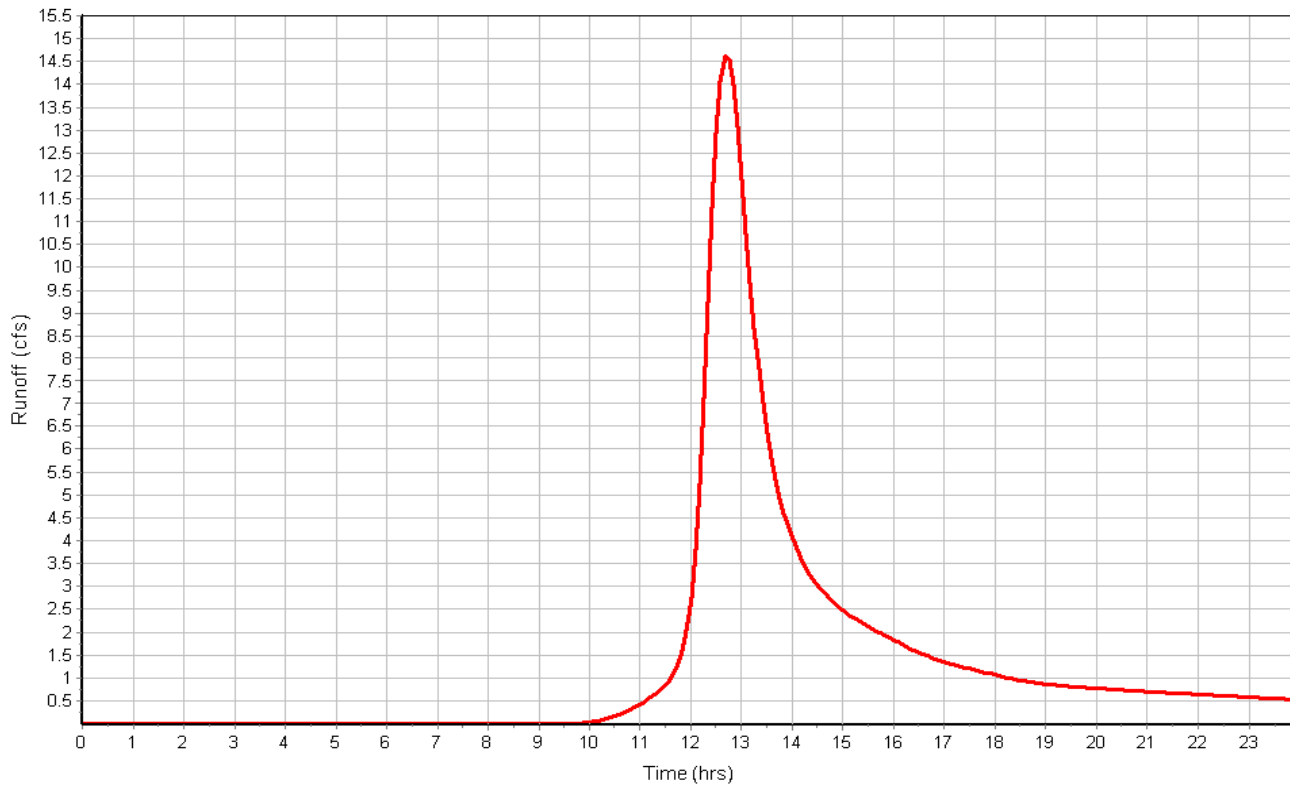

**Subbasin : C2**

**Input Data**

Area (ac) ..... 2.05  
 Weighted Curve Number ..... 82.98  
 Rain Gage ID ..... Rain Gage-01

**Composite Curve Number**

Soil/Surface Description	Area (acres)	Soil Group	Curve Number
> 75% grass cover, Good	0.32	D	80.00
> 75% grass cover, Good	0.76	C	74.00
Gravel roads	0.97	D	91.00
Composite Area & Weighted CN	2.05		82.98

**Time of Concentration**

	Subarea		
	A	B	C
<b>Sheet Flow Computations</b>			
Manning's Roughness :	.01	0.00	0.00
Flow Length (ft) :	60	0.00	0.00
Slope (%) :	2	0.00	0.00
2 yr, 24 hr Rainfall (in) :	3.00	0.00	0.00
Velocity (ft/sec) :	1.30	0.00	0.00
Computed Flow Time (min) :	0.77	0.00	0.00
<b>Channel Flow Computations</b>			
Manning's Roughness :	.03	0.00	0.00
Flow Length (ft) :	2256	0.00	0.00
Channel Slope (%) :	.5	0.00	0.00
Cross Section Area (ft <sup>2</sup> ) :	2.475	0.00	0.00
Wetted Perimeter (ft) :	6.91	0.00	0.00
Velocity (ft/sec) :	1.77	0.00	0.00
Computed Flow Time (min) :	21.23	0.00	0.00
Total TOC (min) .....	22.00		

**Subbasin Runoff Results**

Total Rainfall (in) ..... 4.60  
 Total Runoff (in) ..... 2.81  
 Peak Runoff (cfs) ..... 4.39  
 Weighted Curve Number ..... 82.98  
 Time of Concentration (days hh:mm:ss) ..... 0 00:22:00



**Subbasin : C2**

**Rainfall Intensity Graph**

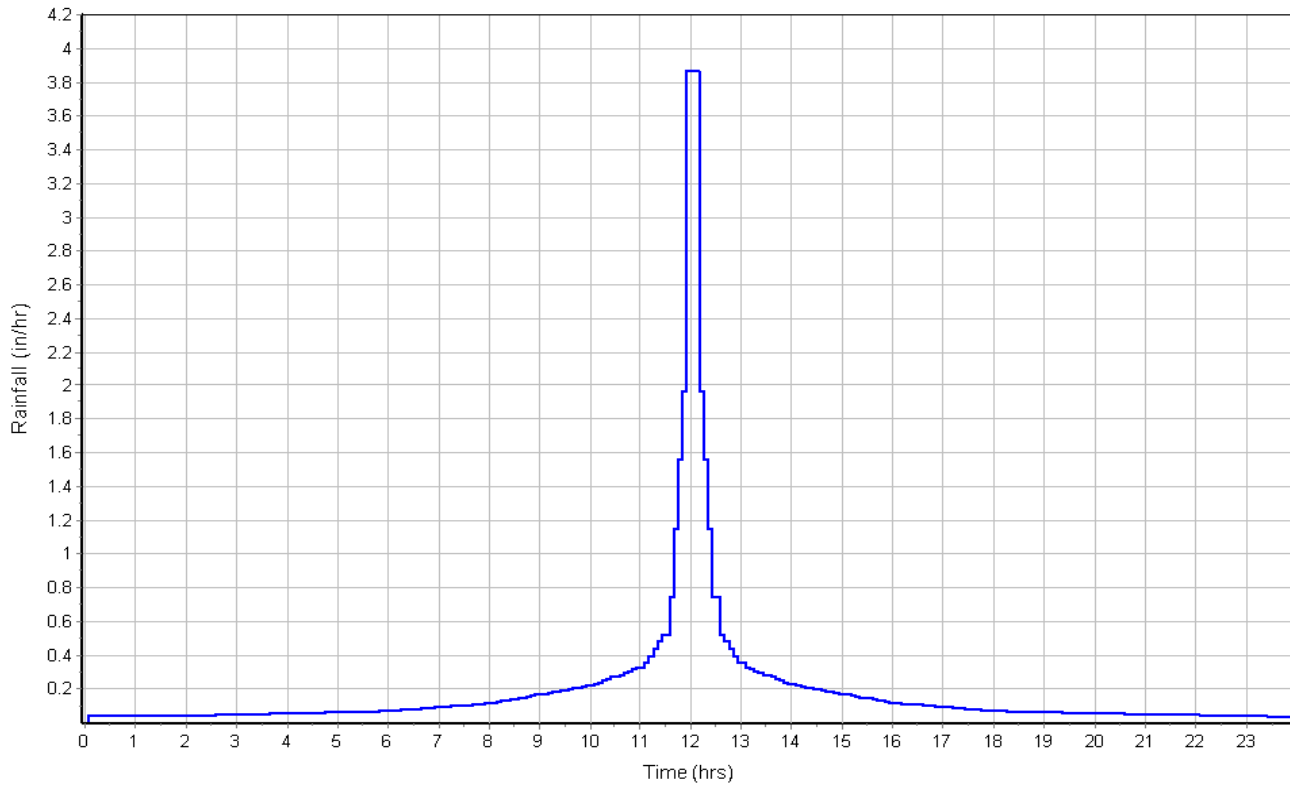

**Runoff Hydrograph**

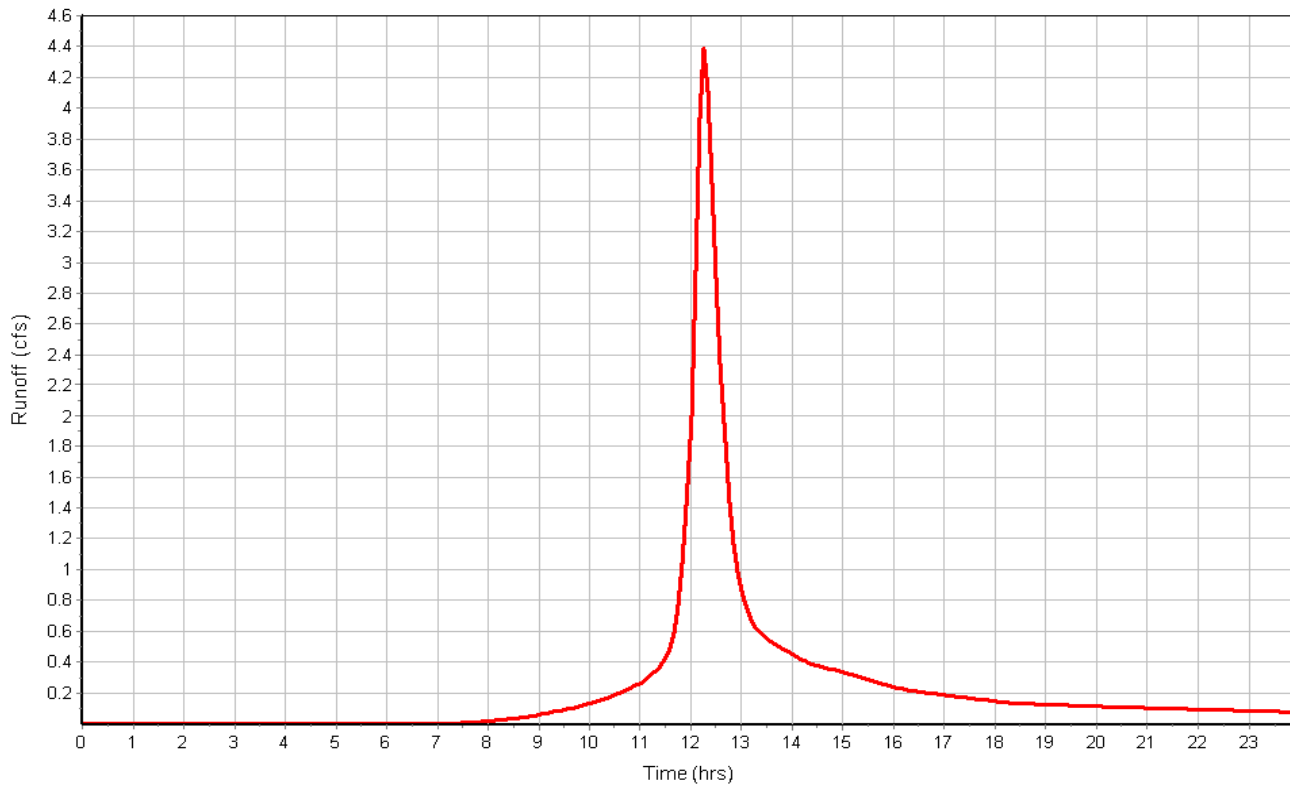

**Subbasin : D**

**Input Data**

Area (ac) ..... 0.59  
 Weighted Curve Number ..... 77.00  
 Rain Gage ID ..... Rain Gage-01

**Composite Curve Number**

Soil/Surface Description	Area (acres)	Soil Group	Curve Number
Woods, Good	0.59	D	77.00
Composite Area & Weighted CN	0.59		77.00

**Time of Concentration**

Sheet Flow Computations	Subarea A	Subarea B	Subarea C
	Manning's Roughness :	.6	0.00
Flow Length (ft) :	100	0.00	0.00
Slope (%) :	21	0.00	0.00
2 yr, 24 hr Rainfall (in) :	3.00	0.00	0.00
Velocity (ft/sec) :	0.14	0.00	0.00
Computed Flow Time (min) :	11.98	0.00	0.00

Shallow Concentrated Flow Computations	Subarea A	Subarea B	Subarea C
	Flow Length (ft) :	16	0.00
Slope (%) :	14.5	0.00	0.00
Surface Type :	Woodland	Unpaved	Unpaved
Velocity (ft/sec) :	1.90	0.00	0.00
Computed Flow Time (min) :	0.14	0.00	0.00
Total TOC (min) .....	12.12		

**Subbasin Runoff Results**

Total Rainfall (in) ..... 4.60  
 Total Runoff (in) ..... 2.29  
 Peak Runoff (cfs) ..... 1.24  
 Weighted Curve Number ..... 77.00  
 Time of Concentration (days hh:mm:ss) ..... 0 00:12:07

Subbasin : D

Rainfall Intensity Graph

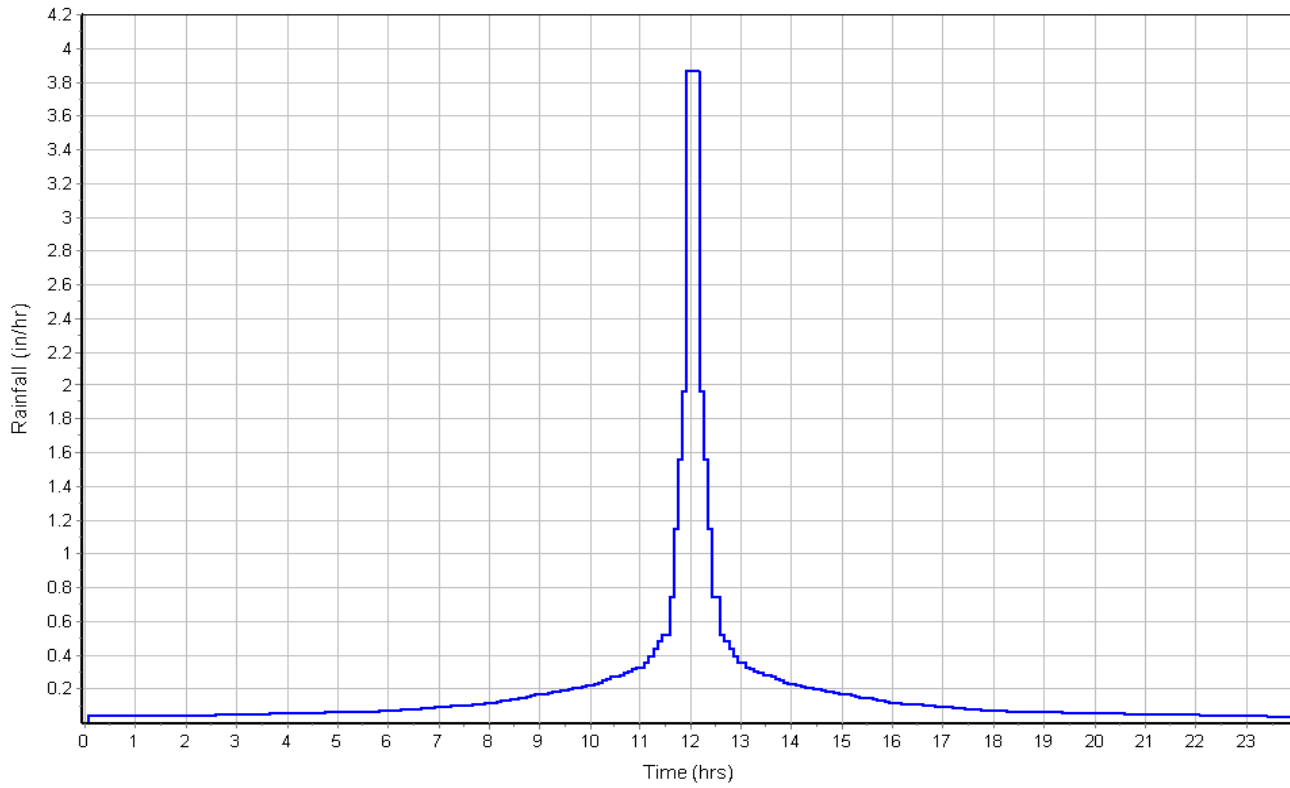

Runoff Hydrograph

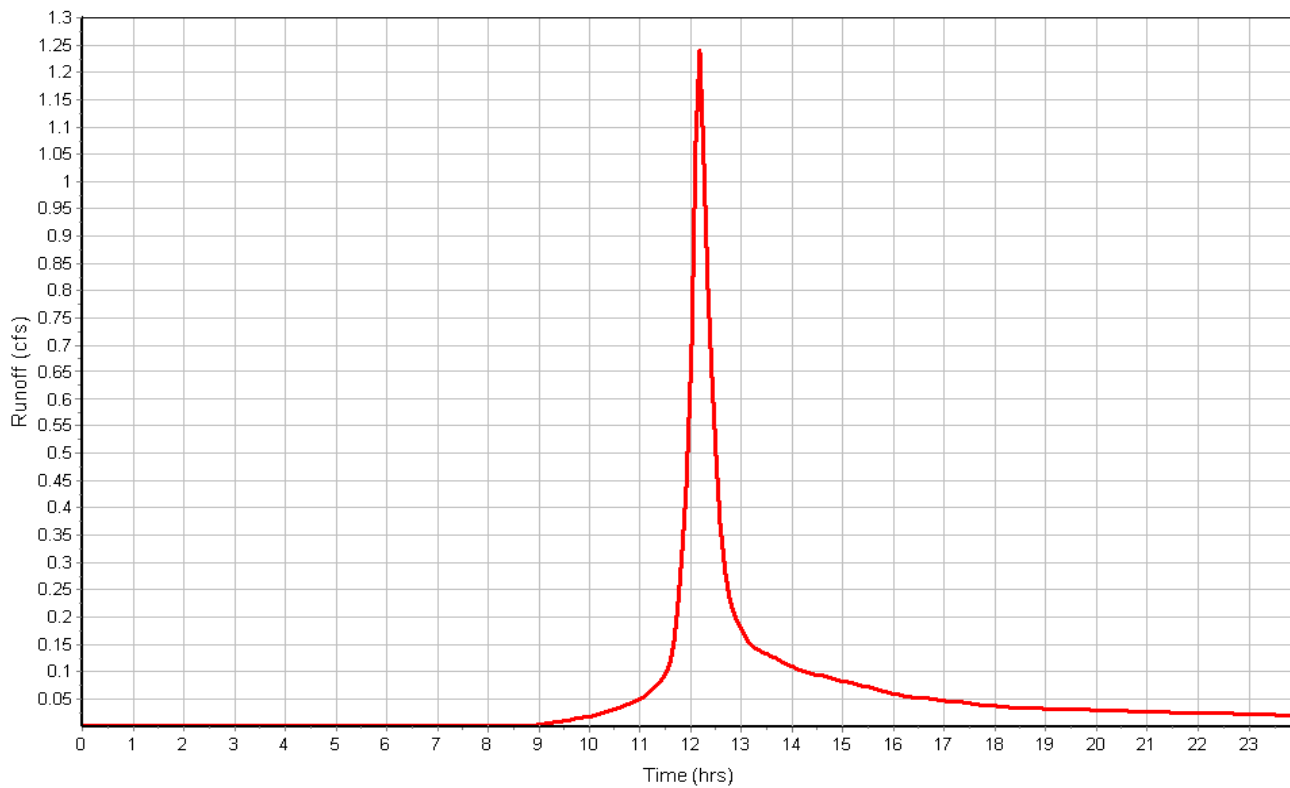

**Subbasin : E**

**Input Data**

Area (ac) ..... 2.86  
 Weighted Curve Number ..... 77.00  
 Rain Gage ID ..... Rain Gage-01

**Composite Curve Number**

Soil/Surface Description	Area (acres)	Soil Group	Curve Number
Woods, Good	2.86	D	77.00
Composite Area & Weighted CN	2.86		77.00

**Time of Concentration**

Sheet Flow Computations	Subarea A	Subarea B	Subarea C
	Manning's Roughness :	.6	0.00
Flow Length (ft) :	100	0.00	0.00
Slope (%) :	24	0.00	0.00
2 yr, 24 hr Rainfall (in) :	3.00	0.00	0.00
Velocity (ft/sec) :	0.15	0.00	0.00
Computed Flow Time (min) :	11.35	0.00	0.00

Shallow Concentrated Flow Computations	Subarea A	Subarea B	Subarea C
	Flow Length (ft) :	227	0.00
Slope (%) :	18	0.00	0.00
Surface Type :	Woodland	Unpaved	Unpaved
Velocity (ft/sec) :	2.12	0.00	0.00
Computed Flow Time (min) :	1.78	0.00	0.00
Total TOC (min) .....	13.14		

**Subbasin Runoff Results**

Total Rainfall (in) ..... 4.60  
 Total Runoff (in) ..... 2.29  
 Peak Runoff (cfs) ..... 5.91  
 Weighted Curve Number ..... 77.00  
 Time of Concentration (days hh:mm:ss) ..... 0 00:13:08

Subbasin : E

Rainfall Intensity Graph

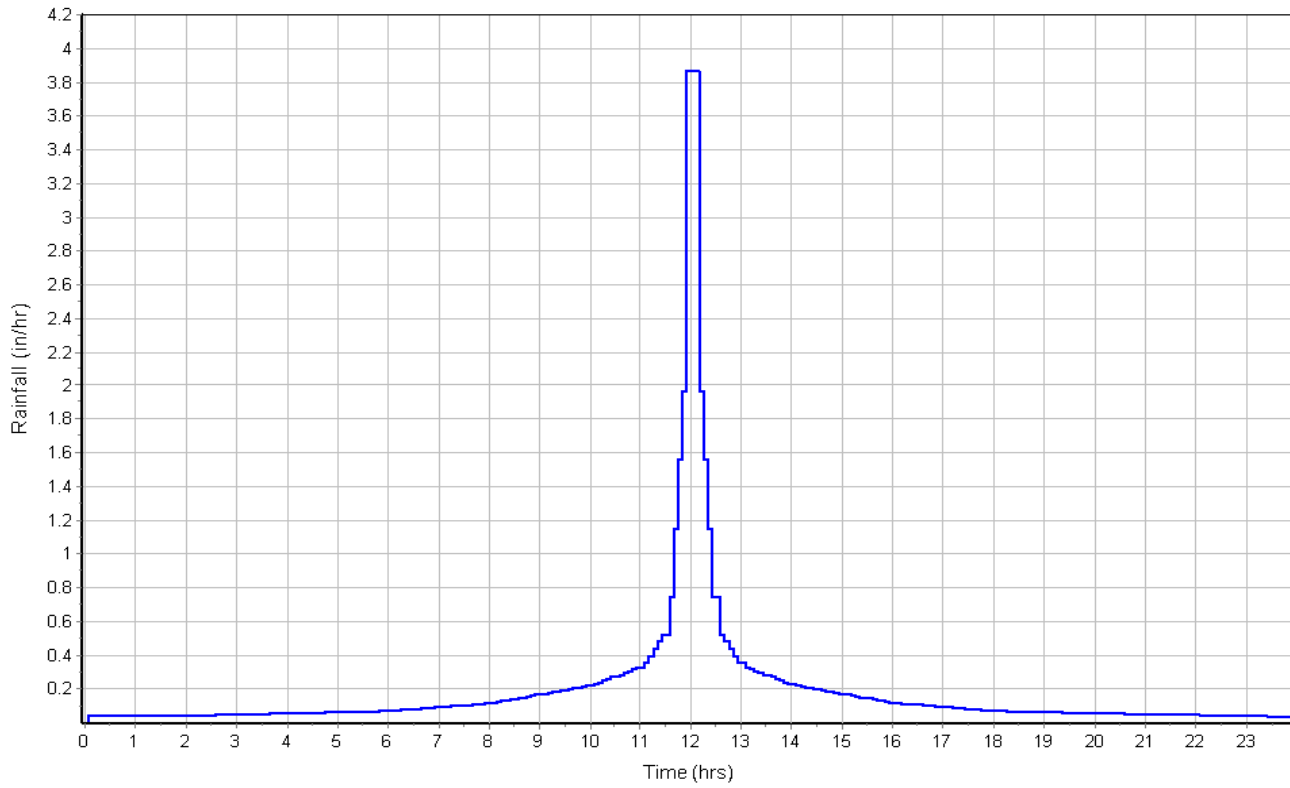

Runoff Hydrograph

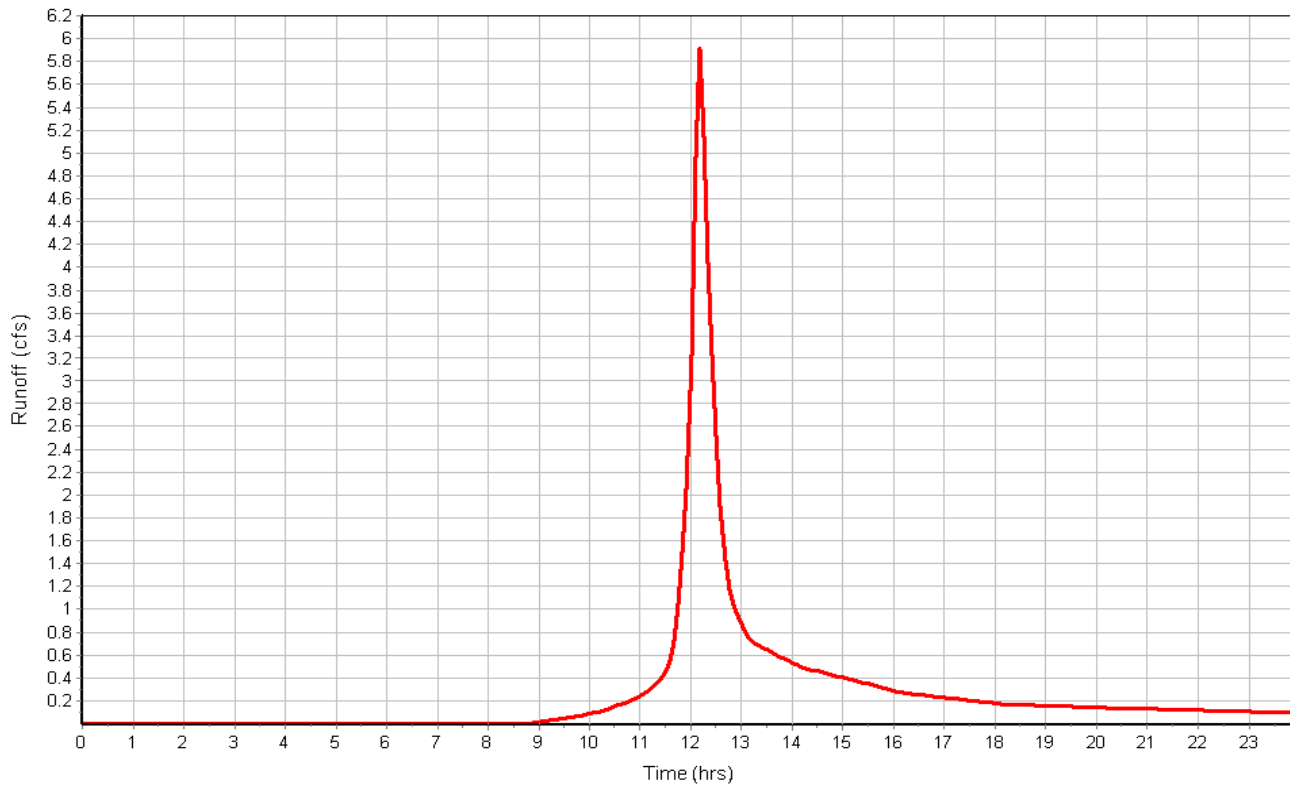

## Junction Input

Element ID	Invert Elevation (ft)	Ground/Rim (Max) Elevation (ft)
CB1	305.30	310.33
CB2	312.00	316.00
OUTLET-STR-A2	305.60	312.00
OUTLET-STR-C2	299.00	305.00

## Junction Results

Element ID	Peak Inflow	Max HGL Elevation Attained	Max HGL Depth Attained	Min Freeboard Attained	Average HGL Elevation Attained	Time of Max HGL Occurrence
	(cfs)	(ft)	(ft)	(ft)	(ft)	(days hh:mm)
CB1	11.11	306.71	1.41	3.62	305.59	0 12:30
CB2	15.56	313.08	1.08	2.92	312.15	0 12:15
OUTLET-STR-A2	6.63	306.49	0.89	5.51	305.79	0 12:17
OUTLET-STR-C2	0.22	299.14	0.14	5.86	299.06	0 16:17

## Pipe Input

Element ID	Length (ft)	Inlet Invert Elevation (ft)	Outlet Invert Elevation (ft)	Average Pipe Slope (%)	Pipe Shape	Pipe Diameter or Height (in)	Pipe Width (in)	Manning's Roughness
CULV-A	98.00	305.30	305.12	0.1800	CIRCULAR	36.000	36.000	0.0150
CULV-A2-1	104.00	312.00	310.00	1.9200	CIRCULAR	24.000	24.000	0.0150
CULV-A2-2	43.00	305.60	305.30	0.7000	CIRCULAR	24.000	24.000	0.0150
CULV-C2	40.00	299.00	298.00	2.5000	CIRCULAR	15.000	15.000	0.0150



## Pipe Results

Element ID	Peak Flow	Time of Peak Flow Occurrence	Design Flow Capacity	Peak Flow Velocity	Peak Flow Depth
	(cfs)	(days hh:mm)	(cfs)	(ft/sec)	(ft)
CULV-A	11.11	0 12:31	24.77	3.41	1.41
CULV-A2-1	15.49	0 12:15	27.19	8.95	1.08
CULV-A2-2	6.63	0 12:17	16.38	4.94	0.88
CULV-C2	0.22	0 16:17	8.85	2.94	0.14

## Storage Nodes

### Storage Node : DETENTION-A

#### Input Data

Invert Elevation (ft) ..... 309.50  
Max (Rim) Elevation (ft) ..... 312.00  
Max (Rim) Offset (ft) ..... 2.50  
Initial Water Elevation (ft) ..... 309.50  
Initial Water Depth (ft) ..... 0.00  
Ponded Area (ft<sup>2</sup>) ..... 0.00  
Evaporation Loss ..... 0.00

#### Storage Area Volume Curves

Storage Curve : Storage-08

Stage (ft)	Storage Area (ft <sup>2</sup> )	Storage Volume (ft <sup>3</sup> )
0	113	0.000
.5	15327	3860.00
1.2	18183.	15588.50
1.5	18635	21111.20
2.5	22257	41557.20

### Storage Area Volume Curves

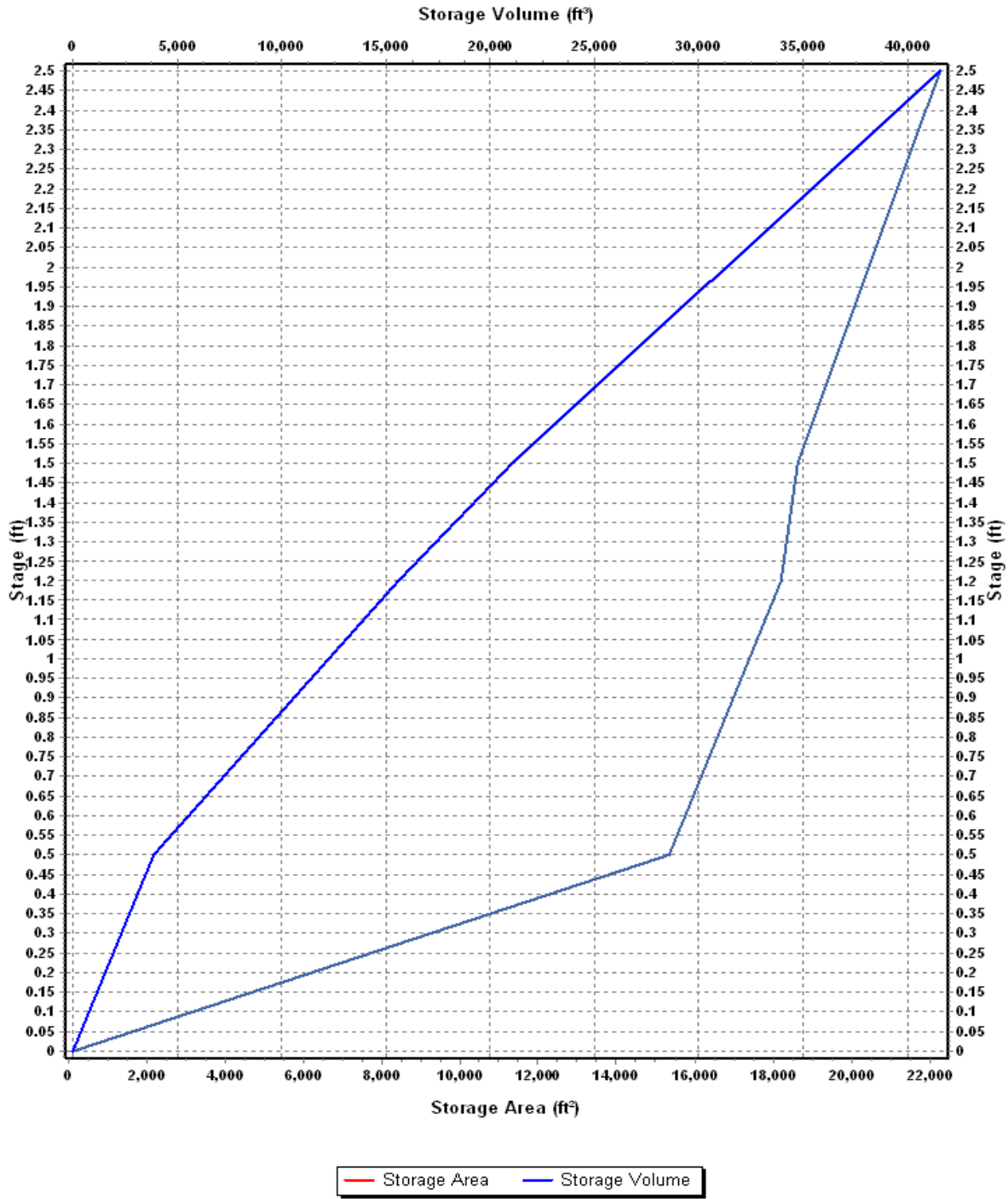

**Storage Node : DETENTION-A (continued)**

**Outflow Orifices**

Element ID	Orifice Type	Orifice Shape	Circular Orifice Diameter (in)	Rectangular Orifice Height (in)	Rectangular Orifice Width (in)	Orifice Invert Elevation (ft)	Orifice Coefficient
BEEHIVE-GRATE	Bottom	CIRCULAR	18.17			310.33	0.61
ORIF-DET-A	Side	Rectangular		4.00	36.00	309.50	0.63

**Output Summary Results**

Peak Inflow (cfs) .....	14.88
Peak Lateral Inflow (cfs) .....	7.06
Peak Outflow (cfs) .....	4.79
Peak Exfiltration Flow Rate (cfm) .....	0.00
Max HGL Elevation Attained (ft) .....	310.42
Max HGL Depth Attained (ft) .....	0.92
Average HGL Elevation Attained (ft) .....	309.59
Average HGL Depth Attained (ft) .....	0.09
Time of Max HGL Occurrence (days hh:mm) .....	0 12:32
Total Exfiltration Volume (1000-ft <sup>3</sup> ) .....	0.000
Total Flooded Volume (ac-in) .....	0
Total Time Flooded (min) .....	0
Total Retention Time (sec) .....	0.00

**Storage Node : FILTER-A2**

**Input Data**

Invert Elevation (ft) .....	308.00
Max (Rim) Elevation (ft) .....	312.00
Max (Rim) Offset (ft) .....	4.00
Initial Water Elevation (ft) .....	309.50
Initial Water Depth (ft) .....	1.50
Ponded Area (ft <sup>2</sup> ) .....	0.00
Evaporation Loss .....	0.00

**Storage Area Volume Curves**

Storage Curve : Storage-05

Stage (ft)	Storage Area (ft <sup>2</sup> )	Storage Volume (ft <sup>3</sup> )
0	2178	0.000
1	4172	3175.00
2	5127	7824.50
3	6050	13413.00
4	7075	19975.50

### Storage Area Volume Curves

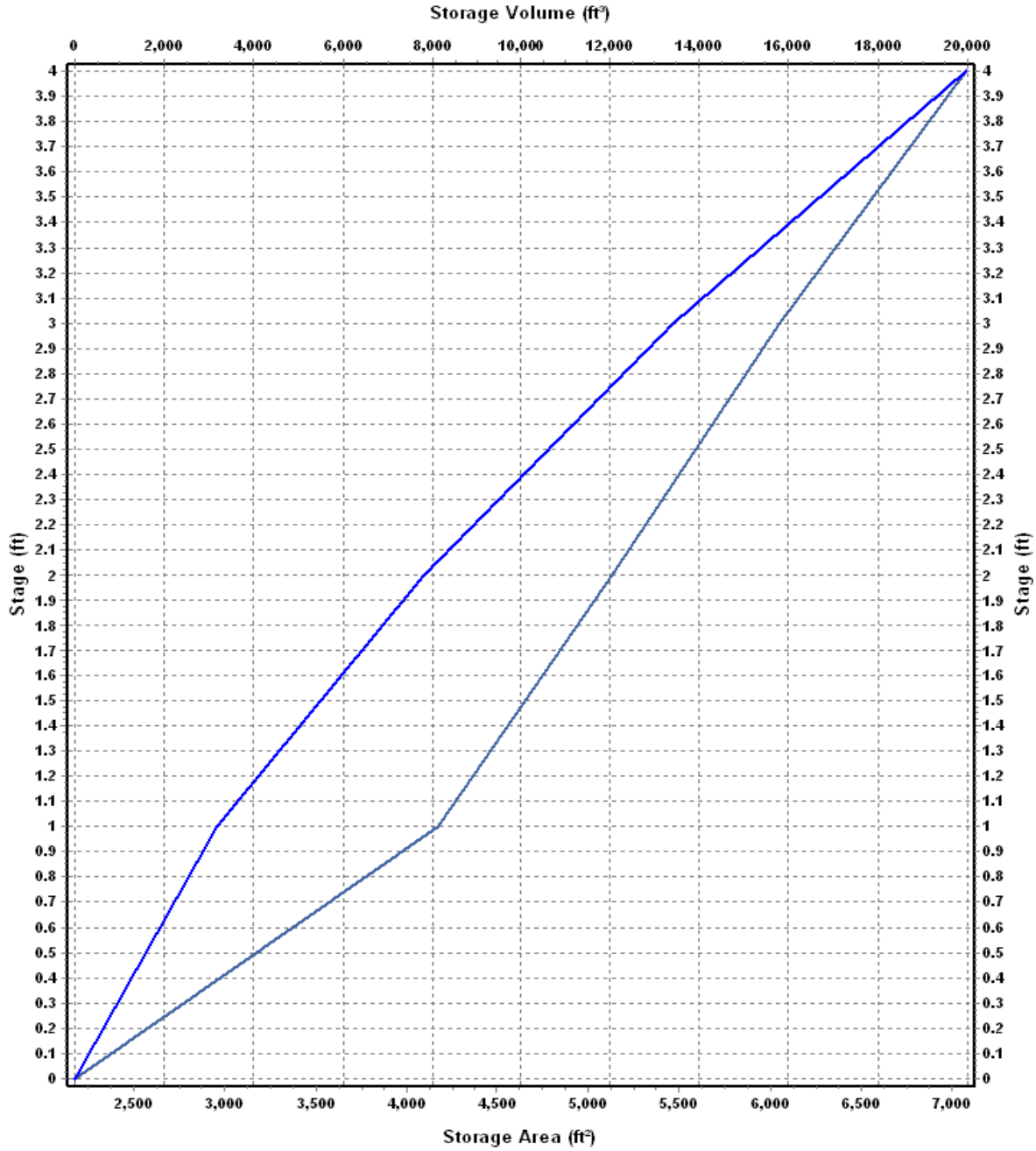

— Storage Area    — Storage Volume

**Storage Node : FILTER-A2 (continued)**

**Outflow Weirs**

Element ID	Weir Type	Crest Elevation (ft)	Length (ft)	Weir Total Height (ft)	Discharge Coefficient
SPILLWAY-A2	Trapezoidal	310.70	40.00	1.30	3.10

**Outflow Orifices**

Element ID	Orifice Type	Orifice Shape	Circular Orifice Diameter (in)	Rectangular Orifice Height (in)	Rectangular Orifice Width (in)	Orifice Invert Elevation (ft)	Orifice Coefficient
ORIF-A2	Side	Rectangular		6.00	30.00	309.50	0.63

**Output Summary Results**

Peak Inflow (cfs)	15.49
Peak Lateral Inflow (cfs)	0.00
Peak Outflow (cfs)	14.89
Peak Exfiltration Flow Rate (cfm)	0.00
Max HGL Elevation Attained (ft)	310.86
Max HGL Depth Attained (ft)	2.86
Average HGL Elevation Attained (ft)	309.65
Average HGL Depth Attained (ft)	1.65
Time of Max HGL Occurrence (days hh:mm)	0 12:17
Total Exfiltration Volume (1000-ft <sup>3</sup> )	0.000
Total Flooded Volume (ac-in)	0
Total Time Flooded (min)	0
Total Retention Time (sec)	0.00

**Storage Node : FILTER-C2**

**Input Data**

Invert Elevation (ft) ..... 301.50  
Max (Rim) Elevation (ft) ..... 305.00  
Max (Rim) Offset (ft) ..... 3.50  
Initial Water Elevation (ft) ..... 301.75  
Initial Water Depth (ft) ..... 0.25  
Ponded Area (ft<sup>2</sup>) ..... 0.00  
Evaporation Loss ..... 0.00

**Storage Area Volume Curves**

Storage Curve : Storage-07

Stage (ft)	Storage Area (ft <sup>2</sup> )	Storage Volume (ft <sup>3</sup> )
0	3380	0.000
.5	6601	2495.25
1.5	8462	10026.75
2.5	10125	19320.25
3.5	11092	29928.75



### Storage Area Volume Curves

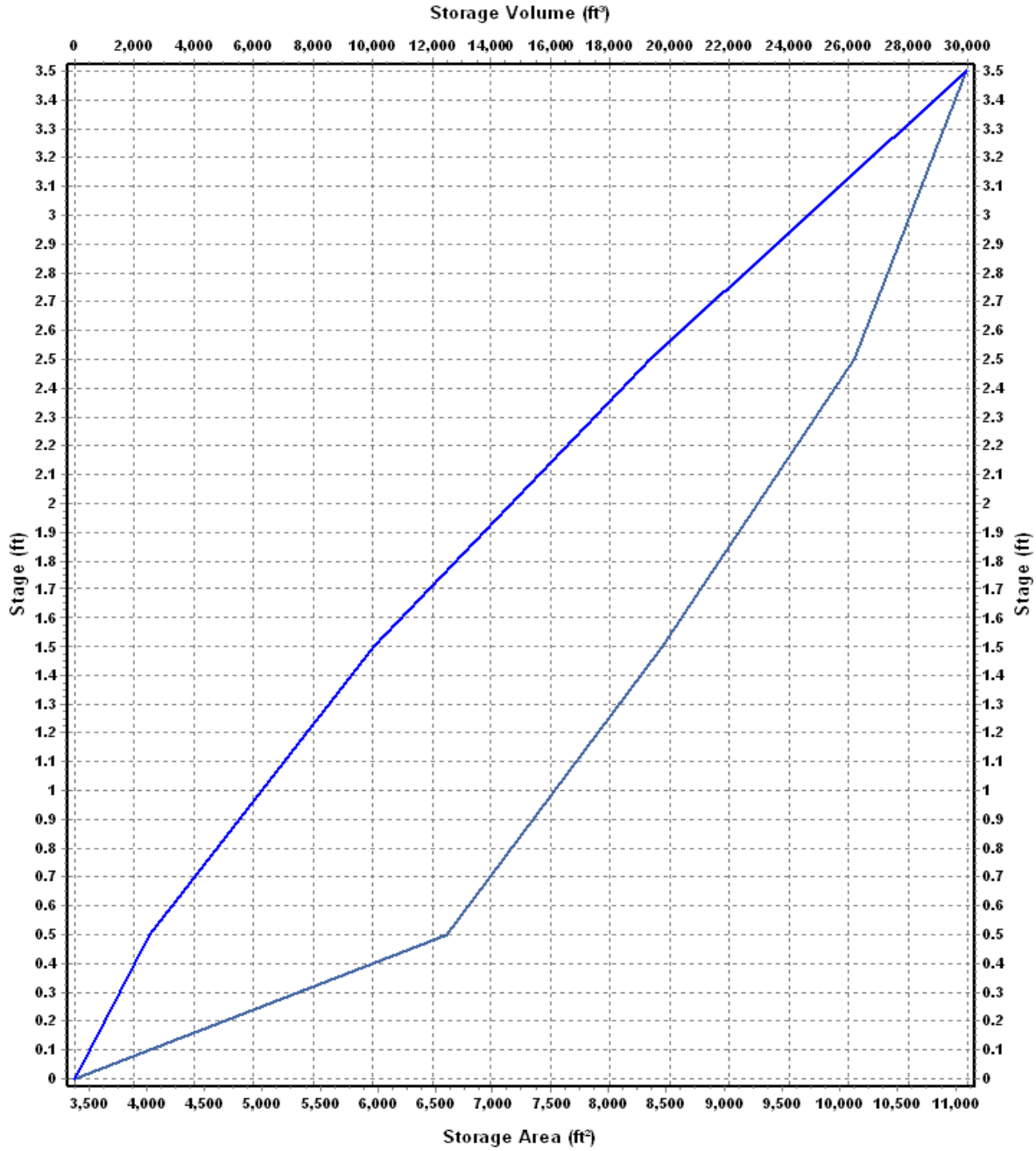

— Storage Area — Storage Volume

**Storage Node : FILTER-C2 (continued)**

**Outflow Weirs**

Element ID	Weir Type	Crest Elevation (ft)	Length (ft)	Weir Total Height (ft)	Discharge Coefficient
SPILLWAY-C2	Trapezoidal	303.80	30.00	1.20	3.10

**Outflow Orifices**

Element ID	Orifice Type	Orifice Shape	Circular Orifice Diameter (in)	Rectangular Orifice Height (in)	Rectangular Orifice Width (in)	Orifice Invert Elevation (ft)	Orifice Coefficient
ORIF-C2	Side	CIRCULAR	4.00			303.25	0.61

**Output Summary Results**

Peak Inflow (cfs) .....	4.39
Peak Lateral Inflow (cfs) .....	4.39
Peak Outflow (cfs) .....	0.22
Peak Exfiltration Flow Rate (cfm) .....	0.00
Max HGL Elevation Attained (ft) .....	303.69
Max HGL Depth Attained (ft) .....	2.19
Average HGL Elevation Attained (ft) .....	302.67
Average HGL Depth Attained (ft) .....	1.17
Time of Max HGL Occurrence (days hh:mm) .....	0 16:17
Total Exfiltration Volume (1000-ft <sup>3</sup> ) .....	0.000
Total Flooded Volume (ac-in) .....	0
Total Time Flooded (min) .....	0
Total Retention Time (sec) .....	0.00

## Project Description

File Name ..... Proposed Conditions 5-30-18.SPF

## Project Options

Flow Units ..... CFS  
 Elevation Type ..... Elevation  
 Hydrology Method ..... SCS TR-55  
 Time of Concentration (TOC) Method ..... SCS TR-55  
 Link Routing Method ..... Kinematic Wave  
 Enable Overflow Ponding at Nodes ..... YES  
 Skip Steady State Analysis Time Periods ..... NO

## Analysis Options

Start Analysis On ..... Jul 13, 2017 00:00:00  
 End Analysis On ..... Jul 14, 2017 00:00:00  
 Start Reporting On ..... Jul 13, 2017 00:00:00  
 Antecedent Dry Days ..... 0 days  
 Runoff (Dry Weather) Time Step ..... 0 01:00:00 days hh:mm:ss  
 Runoff (Wet Weather) Time Step ..... 0 00:05:00 days hh:mm:ss  
 Reporting Time Step ..... 0 00:05:00 days hh:mm:ss  
 Routing Time Step ..... 30 seconds

## Number of Elements

Qty  
 Rain Gages ..... 1  
 Subbasins..... 8  
 Nodes..... 12  
     *Junctions* ..... 4  
     *Outfalls* ..... 5  
     *Flow Diversions* ..... 0  
     *Inlets* ..... 0  
     *Storage Nodes* ..... 3  
 Links..... 10  
     *Channels* ..... 0  
     *Pipes* ..... 4  
     *Pumps* ..... 0  
     *Orifices* ..... 4  
     *Weirs* ..... 2  
     *Outlets* ..... 0  
 Pollutants ..... 0  
 Land Uses ..... 0

## Rainfall Details

SN	Rain Gage ID	Data Source	Data Source ID	Rainfall Type	Rain Units	State	County	Return Period (years)	Rainfall Depth (inches)	Rainfall Distribution
1	Rain Gage-01	Time Series	TS-25	Cumulative	inches	Maine	Androscoggin	25	5.40	SCS Type III 24-hr

## Subbasin Summary

Subbasin ID	Area (ac)	Weighted Curve Number	Total Rainfall (in)	Total Runoff (in)	Total Runoff Volume (ac-in)	Peak Runoff (cfs)	Time of Concentration (days hh:mm:ss)
A1	12.28	73.16	5.40	2.61	32.08	16.85	0 00:49:44
A2	6.41	81.47	5.40	3.39	21.71	19.64	0 00:12:48
A3	4.01	71.75	5.40	2.49	9.98	9.76	0 00:09:08
B	4.99	75.82	5.40	2.85	14.23	10.41	0 00:24:28
C1	15.70	73.25	5.40	2.62	41.13	19.48	0 00:59:49
C2	2.05	82.98	5.40	3.54	7.25	5.50	0 00:22:00
D	0.59	77.00	5.40	2.96	1.75	1.61	0 00:12:07
E	2.86	77.00	5.40	2.96	8.47	7.65	0 00:13:08

## Node Summary

Element ID	Element Type	Invert Elevation
		(ft)
CB1	Junction	305.30
CB2	Junction	312.00
OUTLET-STR-A2	Junction	305.60
OUTLET-STR-C2	Junction	299.00
OUT-A	Outfall	298.00
OUT-B	Outfall	310.00
OUT-C	Outfall	298.00
OUT-D	Outfall	338.00
OUT-E	Outfall	298.00
DETENTION-A	Storage Node	309.50
FILTER-A2	Storage Node	308.00
FILTER-C2	Storage Node	301.50

## Link Summary

Element ID	Element Type	From (Inlet) Node	To (Outlet) Node	Length	Inlet Invert Elevation	Outlet Invert Elevation	Average Slope	Diameter or Height	Manning's Roughness	Peak Flow	Design Flow Capacity	Peak Flow Velocity	Peak Flow Depth
				(ft)	(ft)	(ft)	(%)	(in)		(cfs)	(cfs)	(ft/sec)	(ft)
CULV-A	Pipe	CB1	OUT-A	98.00	305.30	305.12	0.1800	36.000	0.0150	15.49	24.77	3.70	1.72
CULV-A2-1	Pipe	CB2	FILTER-A2	104.00	312.00	310.00	1.9200	24.000	0.0150	19.52	27.19	9.43	1.26
CULV-A2-2	Pipe	OUTLET-STR-A2	CB1	43.00	305.60	305.30	0.7000	24.000	0.0150	6.77	16.38	4.97	0.90
CULV-C2	Pipe	OUTLET-STR-C2	OUT-C	40.00	299.00	298.00	2.5000	15.000	0.0150	0.28	8.85	3.28	0.15
BEEHIVE-GRATE	Orifice	DETENTION-A	CB1		309.50	305.30		18.167		3.86			
ORIF-A2	Orifice	FILTER-A2	OUTLET-STR-A2		308.00	305.60		6.000		6.77			
ORIF-C2	Orifice	FILTER-C2	OUTLET-STR-C2		301.50	299.00		4.000		0.28			
ORIF-DET-A	Orifice	DETENTION-A	CB1		309.50	305.30		4.000		5.16			
SPILLWAY-A2	Weir	FILTER-A2	DETENTION-A		308.00	309.50				12.44			
SPILLWAY-C2	Weir	FILTER-C2	OUT-C		301.50	298.00				0.42			

## Subbasin Hydrology

### Subbasin : A1

#### Input Data

Area (ac) ..... 12.28  
 Weighted Curve Number ..... 73.16  
 Rain Gage ID ..... Rain Gage-01

#### Composite Curve Number

Soil/Surface Description	Area (acres)	Soil Group	Curve Number
Woods, Good	4.58	D	77.00
> 75% grass cover, Good	0.68	C	74.00
Woods, Good	6.62	C	70.00
> 75% grass cover, Good	0.40	D	80.00
Composite Area & Weighted CN	12.28		73.16

#### Time of Concentration

TOC Method : SCS TR-55

Sheet Flow Equation :

$$T_c = (0.007 * ((n * L_f)^{0.8})) / ((P^{0.5}) * (S_f^{0.4}))$$

Where :

Tc = Time of Concentration (hr)  
 n = Manning's roughness  
 Lf = Flow Length (ft)  
 P = 2 yr, 24 hr Rainfall (inches)  
 Sf = Slope (ft/ft)

Shallow Concentrated Flow Equation :

V = 16.1345 \* (Sf<sup>0.5</sup>) (unpaved surface)  
 V = 20.3282 \* (Sf<sup>0.5</sup>) (paved surface)  
 V = 15.0 \* (Sf<sup>0.5</sup>) (grassed waterway surface)  
 V = 10.0 \* (Sf<sup>0.5</sup>) (nearly bare & untilled surface)  
 V = 9.0 \* (Sf<sup>0.5</sup>) (cultivated straight rows surface)  
 V = 7.0 \* (Sf<sup>0.5</sup>) (short grass pasture surface)  
 V = 5.0 \* (Sf<sup>0.5</sup>) (woodland surface)  
 V = 2.5 \* (Sf<sup>0.5</sup>) (forest w/heavy litter surface)  
 Tc = (Lf / V) / (3600 sec/hr)

Where:

Tc = Time of Concentration (hr)  
 Lf = Flow Length (ft)  
 V = Velocity (ft/sec)  
 Sf = Slope (ft/ft)

Channel Flow Equation :

V = (1.49 \* (R<sup>2/3</sup>)) \* (Sf<sup>0.5</sup>) / n  
 R = Aq / Wp  
 Tc = (Lf / V) / (3600 sec/hr)

Where :

Tc = Time of Concentration (hr)  
 Lf = Flow Length (ft)  
 R = Hydraulic Radius (ft)  
 Aq = Flow Area (ft<sup>2</sup>)  
 Wp = Wetted Perimeter (ft)  
 V = Velocity (ft/sec)  
 Sf = Slope (ft/ft)  
 n = Manning's roughness

	Subarea	Subarea	Subarea
	A	B	C
<b>Sheet Flow Computations</b>			
Manning's Roughness :	.6	0.00	0.00
Flow Length (ft) :	100	0.00	0.00
Slope (%) :	2	0.00	0.00
2 yr, 24 hr Rainfall (in) :	3.00	0.00	0.00
Velocity (ft/sec) :	0.05	0.00	0.00
Computed Flow Time (min) :	30.68	0.00	0.00
<b>Shallow Concentrated Flow Computations</b>			
	Subarea	Subarea	Subarea
	A	B	C
Flow Length (ft) :	1510	0.00	0.00
Slope (%) :	.78	0.00	0.00
Surface Type :		Unpaved	Unpaved
Velocity (ft/sec) :	1.32	0.00	0.00
Computed Flow Time (min) :	19.07	0.00	0.00
Total TOC (min) .....	49.74		

**Subbasin Runoff Results**

Total Rainfall (in) .....	5.40
Total Runoff (in) .....	2.61
Peak Runoff (cfs) .....	16.85
Weighted Curve Number .....	73.16
Time of Concentration (days hh:mm:ss) .....	0 00:49:44



Subbasin : A1

Rainfall Intensity Graph

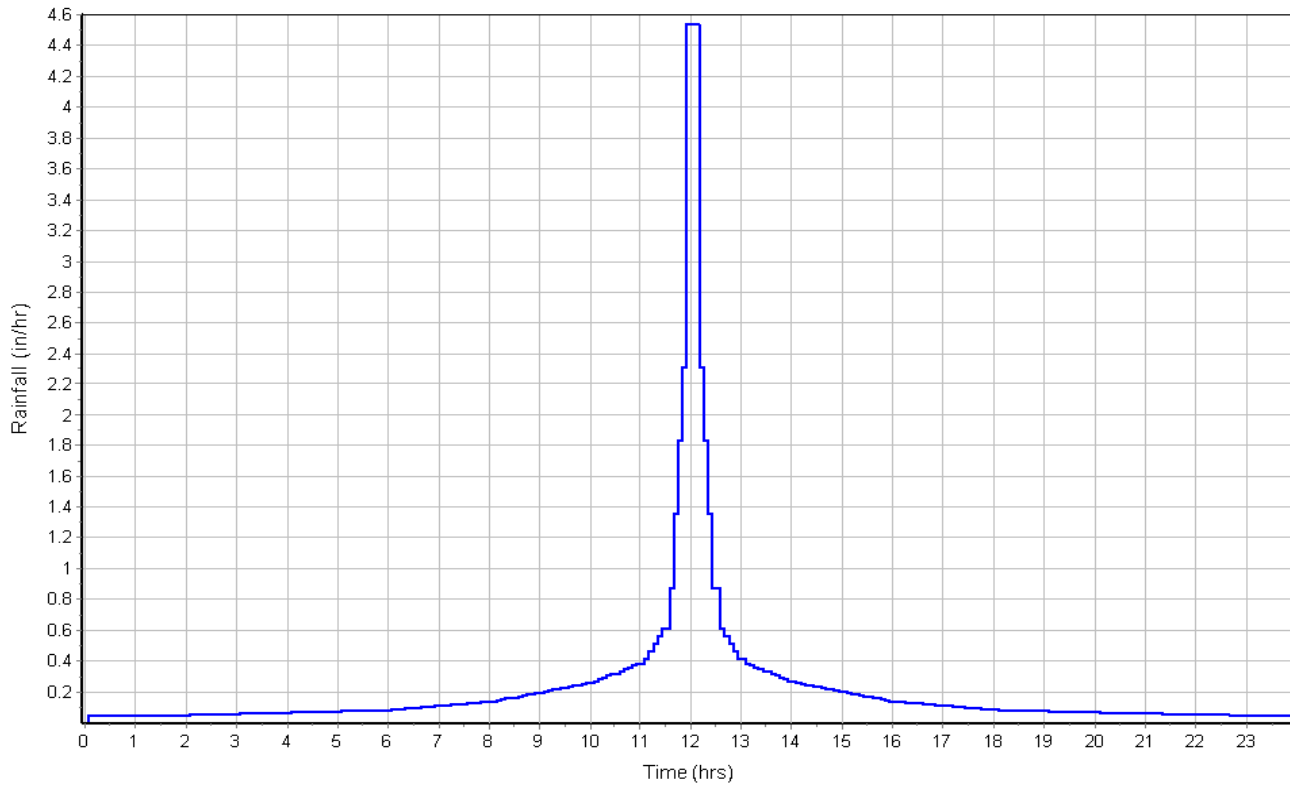

Runoff Hydrograph

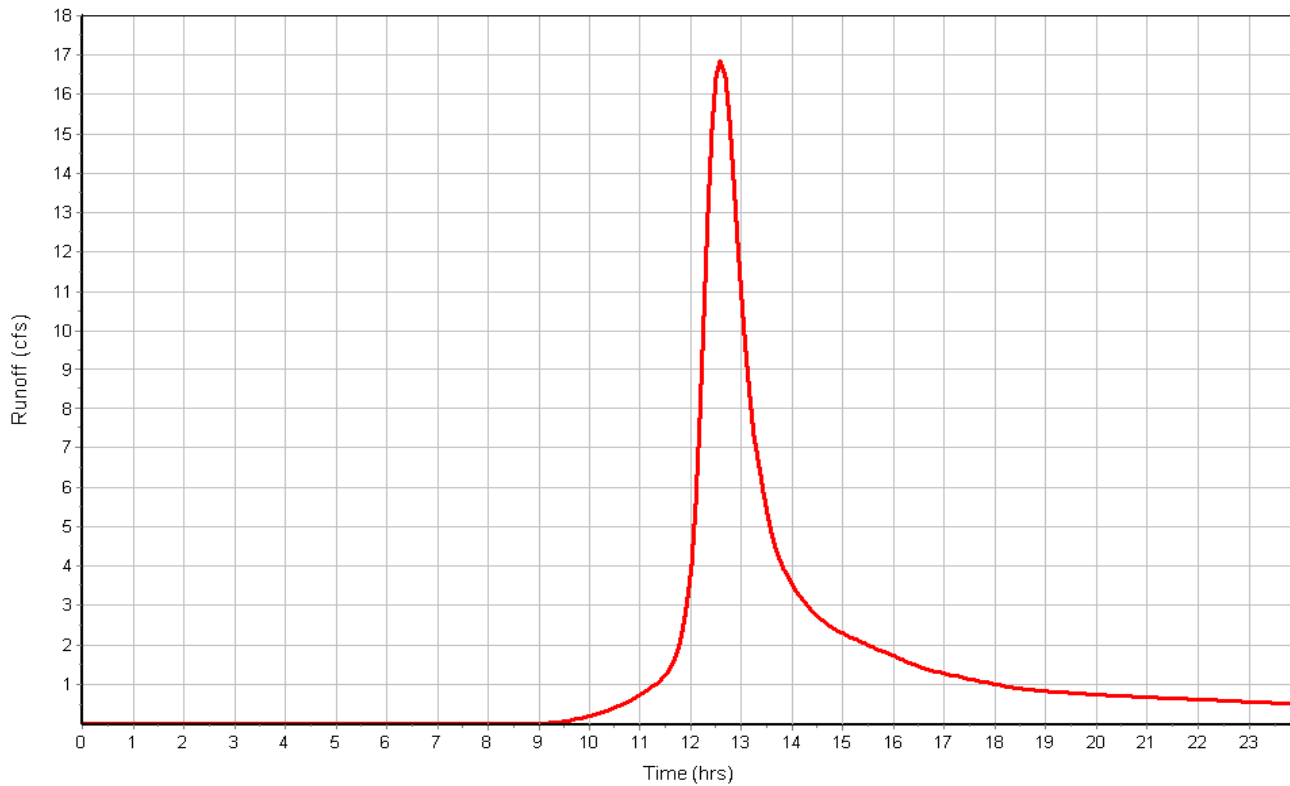

**Subbasin : A2**

**Input Data**

Area (ac) ..... 6.41  
 Weighted Curve Number ..... 81.47  
 Rain Gage ID ..... Rain Gage-01

**Composite Curve Number**

Soil/Surface Description	Area (acres)	Soil Group	Curve Number
Woods, Good	0.13	D	77.00
Roofs	1.77	D	98.00
> 75% grass cover, Good	1.87	D	80.00
Stone_Pad	1.80	D	60.00
Gravel roads	0.17	D	91.00
Pavement	0.67	D	98.00
Composite Area & Weighted CN	6.41		81.47

**Time of Concentration**

	Subarea	Subarea	Subarea
	A	B	C
<b>Sheet Flow Computations</b>			
Manning's Roughness :	.4	0.00	0.00
Flow Length (ft) :	85	0.00	0.00
Slope (%) :	33.33	0.00	0.00
2 yr, 24 hr Rainfall (in) :	3.00	0.00	0.00
Velocity (ft/sec) :	0.22	0.00	0.00
Computed Flow Time (min) :	6.32	0.00	0.00
<b>Channel Flow Computations</b>			
Manning's Roughness :	.04	0.00	0.00
Flow Length (ft) :	1138	0.00	0.00
Channel Slope (%) :	1.4	0.00	0.00
Cross Section Area (ft <sup>2</sup> ) :	4.398	0.00	0.00
Wetted Perimeter (ft) :	8.12	0.00	0.00
Velocity (ft/sec) :	2.93	0.00	0.00
Computed Flow Time (min) :	6.48	0.00	0.00
Total TOC (min) .....	12.80		

**Subbasin Runoff Results**

Total Rainfall (in) ..... 5.40  
 Total Runoff (in) ..... 3.39  
 Peak Runoff (cfs) ..... 19.64  
 Weighted Curve Number ..... 81.47  
 Time of Concentration (days hh:mm:ss) ..... 0 00:12:48

Subbasin : A2

Rainfall Intensity Graph

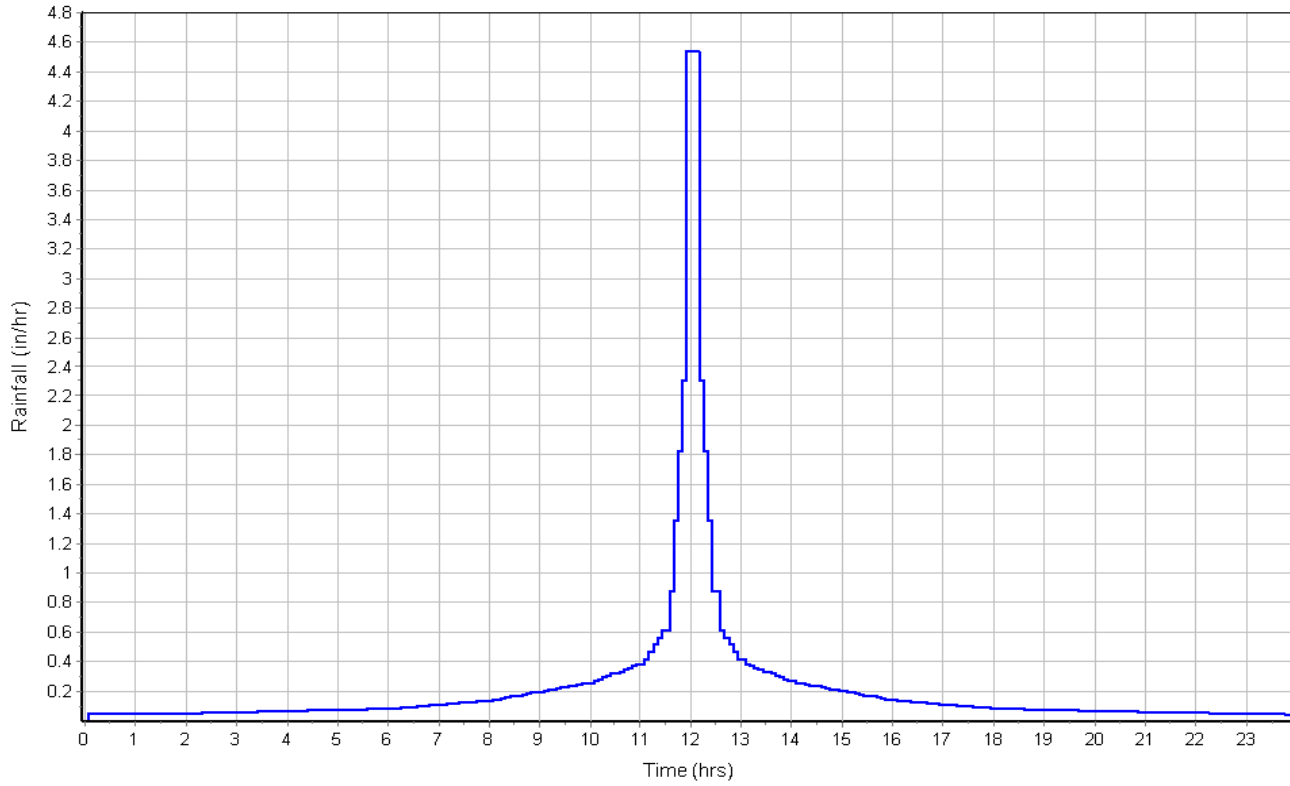

Runoff Hydrograph

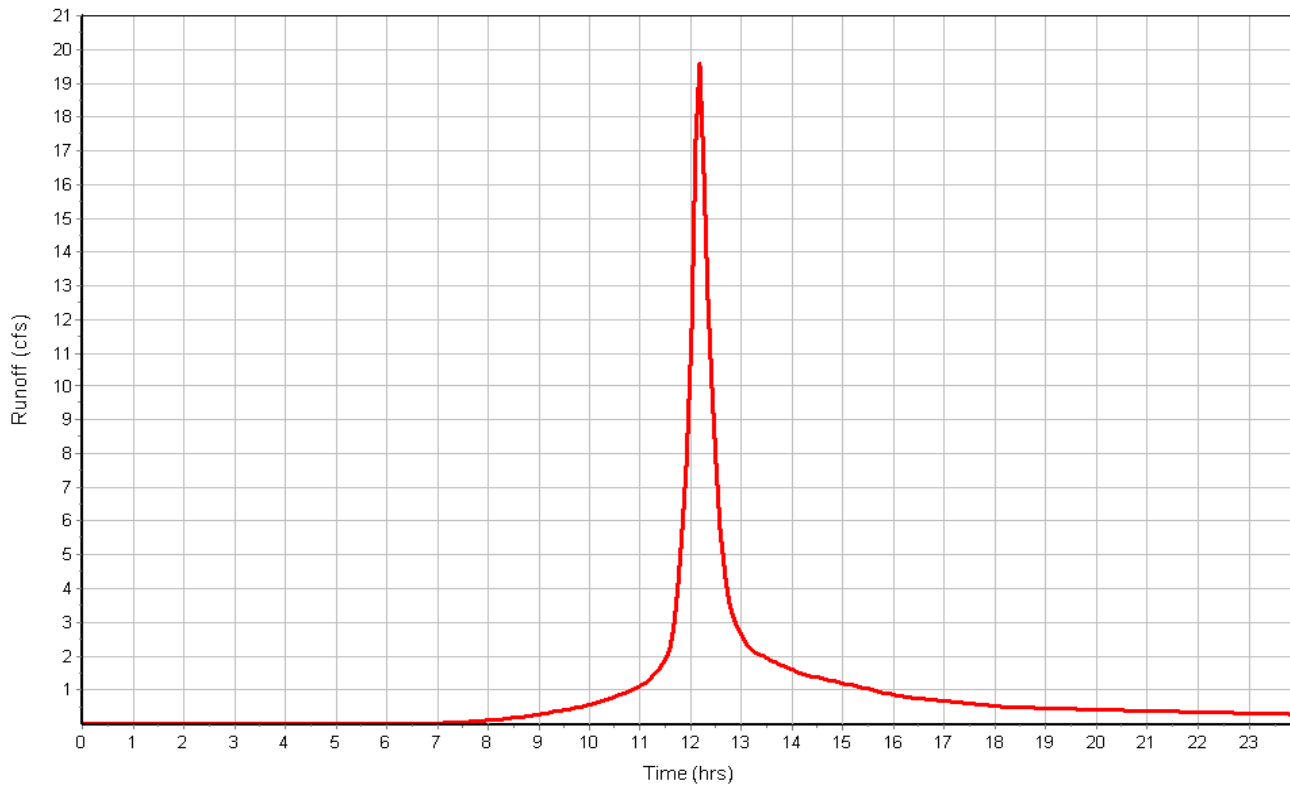

**Subbasin : A3**

**Input Data**

Area (ac) ..... 4.01  
 Weighted Curve Number ..... 71.75  
 Rain Gage ID ..... Rain Gage-01

**Composite Curve Number**

Soil/Surface Description	Area (acres)	Soil Group	Curve Number
> 75% grass cover, Good	0.75	D	80.00
> 75% grass cover, Good	0.14	C	74.00
Stone_Pad	2.28	D	60.00
Roofs	0.19	D	98.00
Gravel roads	0.25	D	91.00
Pavement	0.35	D	98.00
Foundations	0.05	D	98.00
Composite Area & Weighted CN	4.01		71.75

**Time of Concentration**

Sheet Flow Computations	Subarea A	Subarea B	Subarea C
	Manning's Roughness :	.01	0.00
Flow Length (ft) :	100	0.00	0.00
Slope (%) :	2	0.00	0.00
2 yr, 24 hr Rainfall (in) :	3.00	0.00	0.00
Velocity (ft/sec) :	1.44	0.00	0.00
Computed Flow Time (min) :	1.16	0.00	0.00

Shallow Concentrated Flow Computations	Subarea A	Subarea B	Subarea C
	Flow Length (ft) :	548	25
Slope (%) :	2	33.33	1.5
Surface Type :	Unpaved		
Velocity (ft/sec) :	2.28	4.04	0.86
Computed Flow Time (min) :	4.01	0.10	3.88
Total TOC (min) .....	9.14		

**Subbasin Runoff Results**

Total Rainfall (in) ..... 5.40  
 Total Runoff (in) ..... 2.49  
 Peak Runoff (cfs) ..... 9.76  
 Weighted Curve Number ..... 71.75  
 Time of Concentration (days hh:mm:ss) ..... 0 00:09:08

Subbasin : A3

Rainfall Intensity Graph

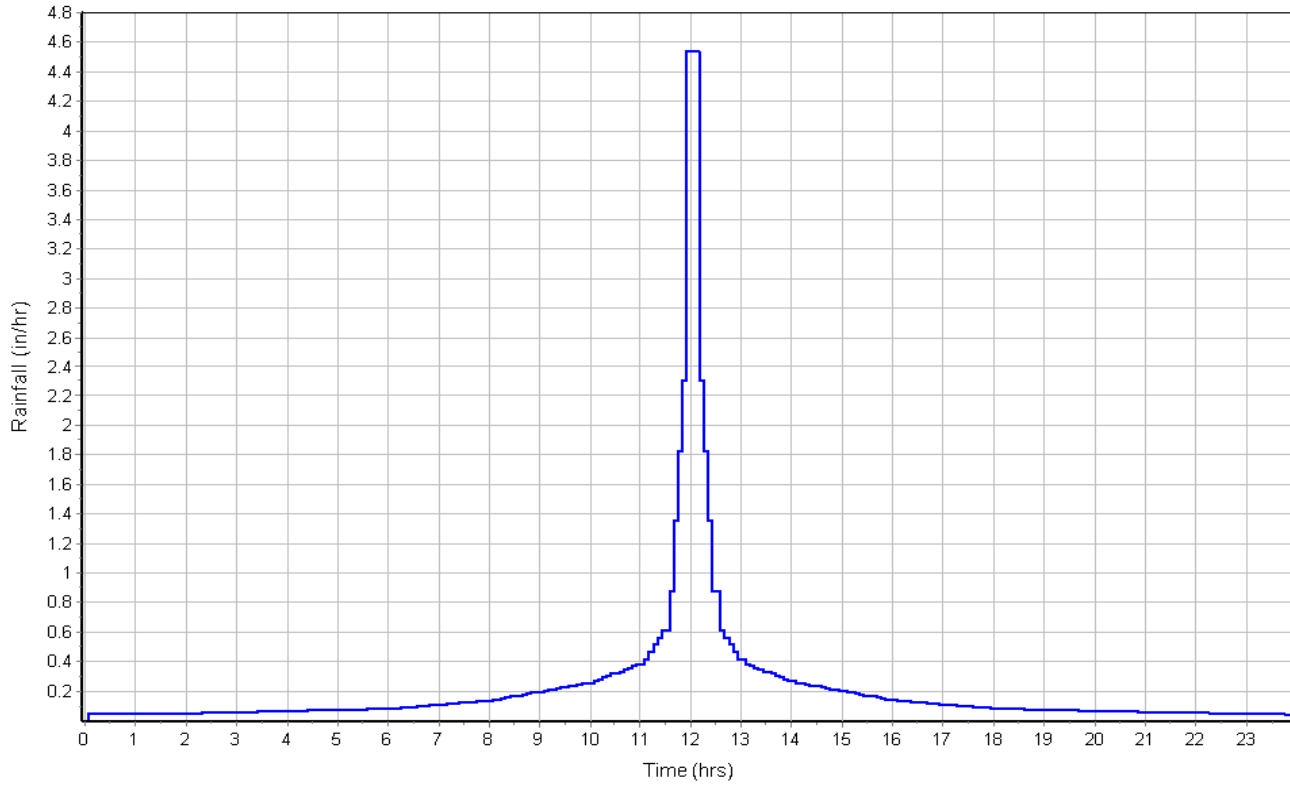

Runoff Hydrograph

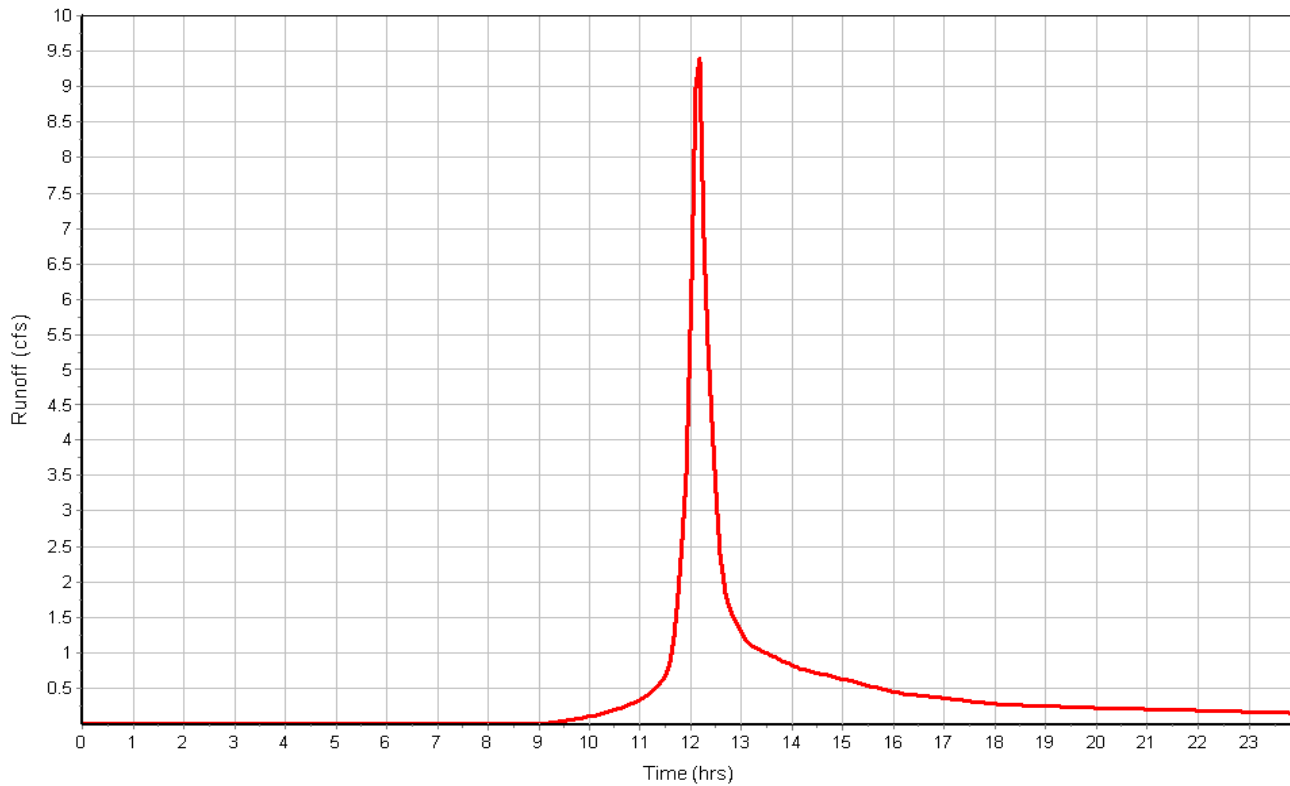

**Subbasin : B**

**Input Data**

Area (ac) ..... 4.99  
 Weighted Curve Number ..... 75.82  
 Rain Gage ID ..... Rain Gage-01

**Composite Curve Number**

Soil/Surface Description	Area (acres)	Soil Group	Curve Number
Woods, Good	1.05	C	70.00
Woods, Good	3.45	D	77.00
> 75% grass cover, Good	0.49	D	80.00
Composite Area & Weighted CN	4.99		75.82

**Time of Concentration**

	Subarea		
	A	B	C
<b>Sheet Flow Computations</b>			
Manning's Roughness :	.4	0.00	0.00
Flow Length (ft) :	90	0.00	0.00
Slope (%) :	33.33	0.00	0.00
2 yr, 24 hr Rainfall (in) :	3.00	0.00	0.00
Velocity (ft/sec) :	0.23	0.00	0.00
Computed Flow Time (min) :	6.62	0.00	0.00
<b>Shallow Concentrated Flow Computations</b>			
Flow Length (ft) :	368	0.00	0.00
Slope (%) :	1.63	0.00	0.00
Surface Type :		Unpaved	Unpaved
Velocity (ft/sec) :	1.92	0.00	0.00
Computed Flow Time (min) :	3.19	0.00	0.00
<b>Channel Flow Computations</b>			
Manning's Roughness :	.3	.3	0.00
Flow Length (ft) :	272	85	0.00
Channel Slope (%) :	1.4	16.7	0.00
Cross Section Area (ft²) :	3.287	1.367	0.00
Wetted Perimeter (ft) :	7.17	5.15	0.00
Velocity (ft/sec) :	0.35	0.84	0.00
Computed Flow Time (min) :	12.97	1.69	0.00
Total TOC (min) .....	24.48		

**Subbasin Runoff Results**

Total Rainfall (in) ..... 5.40  
 Total Runoff (in) ..... 2.85  
 Peak Runoff (cfs) ..... 10.41  
 Weighted Curve Number ..... 75.82  
 Time of Concentration (days hh:mm:ss) ..... 0 00:24:29

**Subbasin : B**

**Rainfall Intensity Graph**

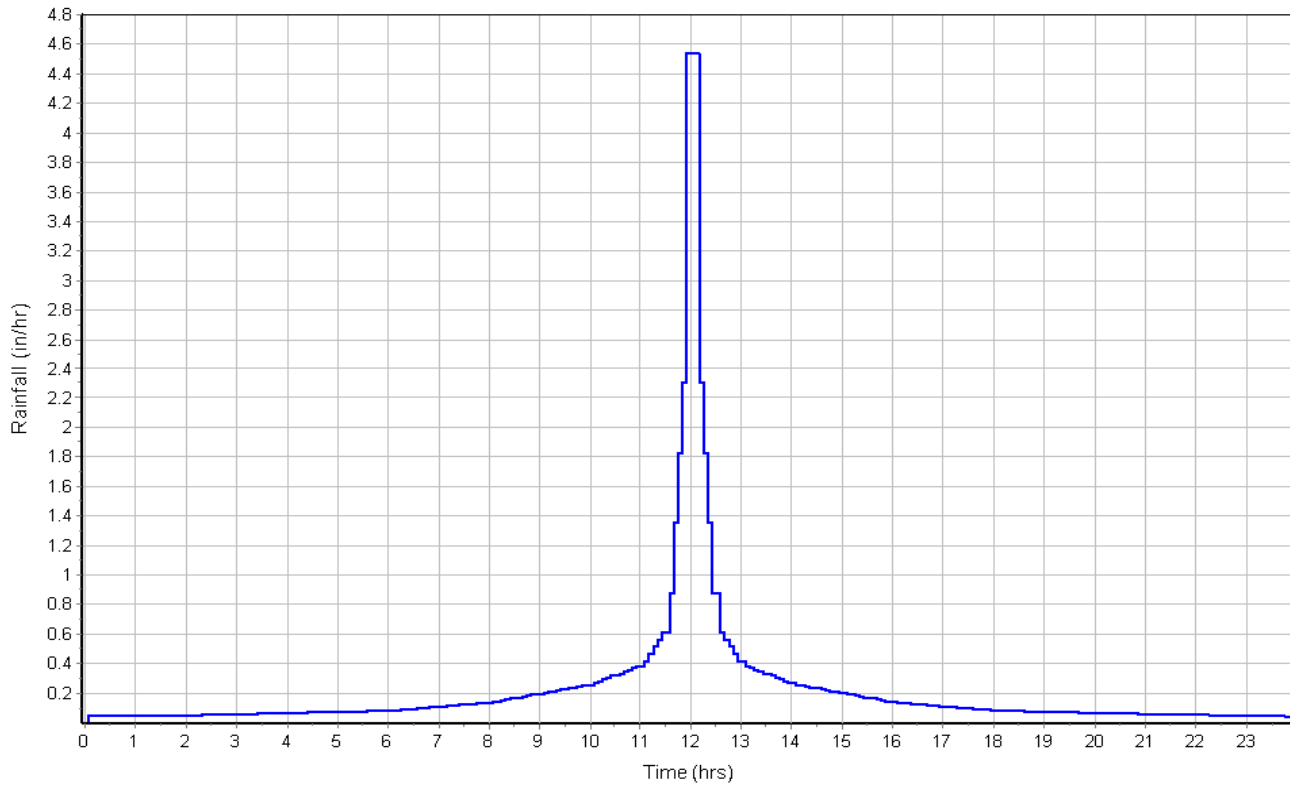

**Runoff Hydrograph**

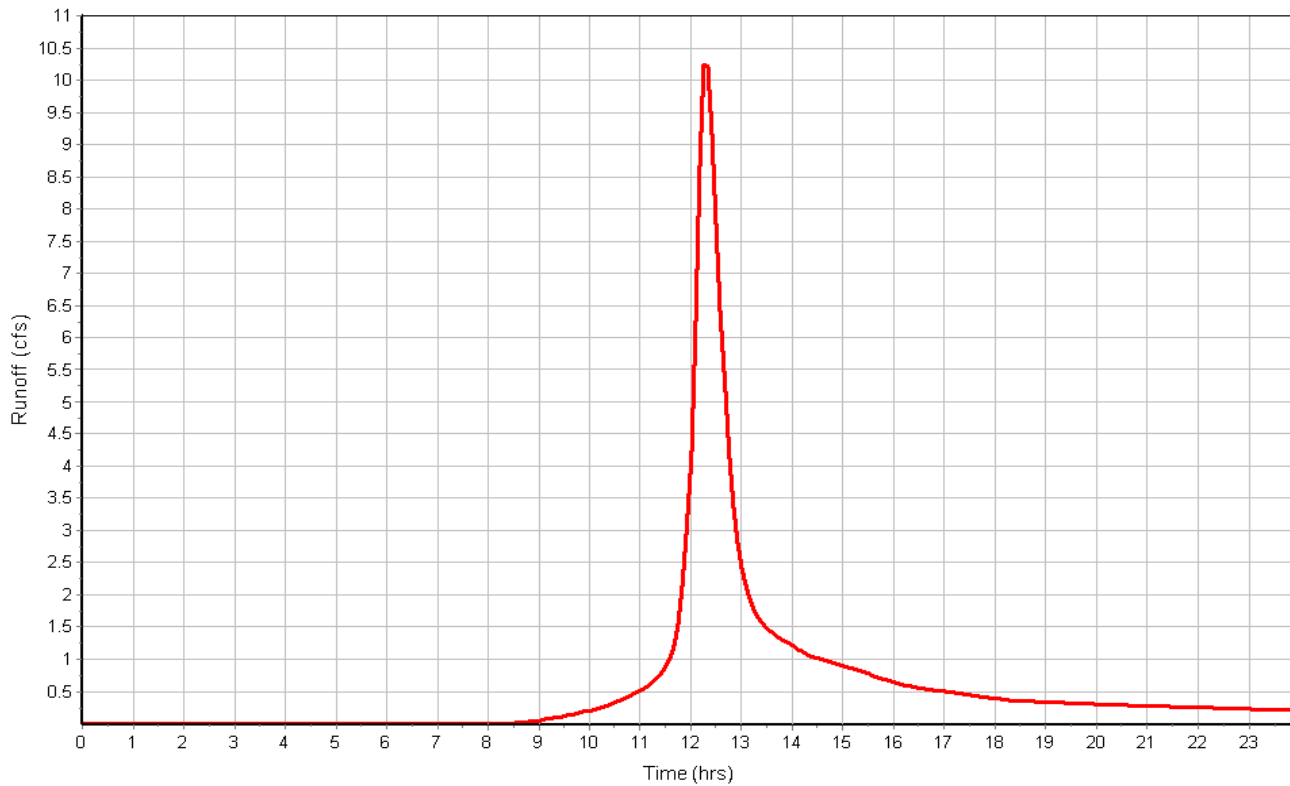

**Subbasin : C1**

**Input Data**

Area (ac) ..... 15.70  
 Weighted Curve Number ..... 73.25  
 Rain Gage ID ..... Rain Gage-01

**Composite Curve Number**

Soil/Surface Description	Area (acres)	Soil Group	Curve Number
Gravel roads	0.17	D	91.00
> 75% grass cover, Good	0.04	D	80.00
Woods, Good	8.63	C	70.00
Woods, Good	6.55	D	77.00
> 75% grass cover, Good	0.31	C	74.00
Composite Area & Weighted CN	15.70		73.25

**Time of Concentration**

Sheet Flow Computations	Subarea	Subarea	Subarea
	A	B	C
Manning's Roughness :	.6	0.00	0.00
Flow Length (ft) :	100	0.00	0.00
Slope (%) :	2	0.00	0.00
2 yr, 24 hr Rainfall (in) :	3.00	0.00	0.00
Velocity (ft/sec) :	0.05	0.00	0.00
Computed Flow Time (min) :	30.68	0.00	0.00
Shallow Concentrated Flow Computations	Subarea	Subarea	Subarea
	A	B	C
Flow Length (ft) :	1907	0.00	0.00
Slope (%) :	.524	0.00	0.00
Surface Type :		Unpaved	Unpaved
Velocity (ft/sec) :	1.09	0.00	0.00
Computed Flow Time (min) :	29.16	0.00	0.00
Total TOC (min) .....59.83			

**Subbasin Runoff Results**

Total Rainfall (in) ..... 5.40  
 Total Runoff (in) ..... 2.62  
 Peak Runoff (cfs) ..... 19.48  
 Weighted Curve Number ..... 73.25  
 Time of Concentration (days hh:mm:ss) ..... 0 00:59:50



Subbasin : C1

Rainfall Intensity Graph

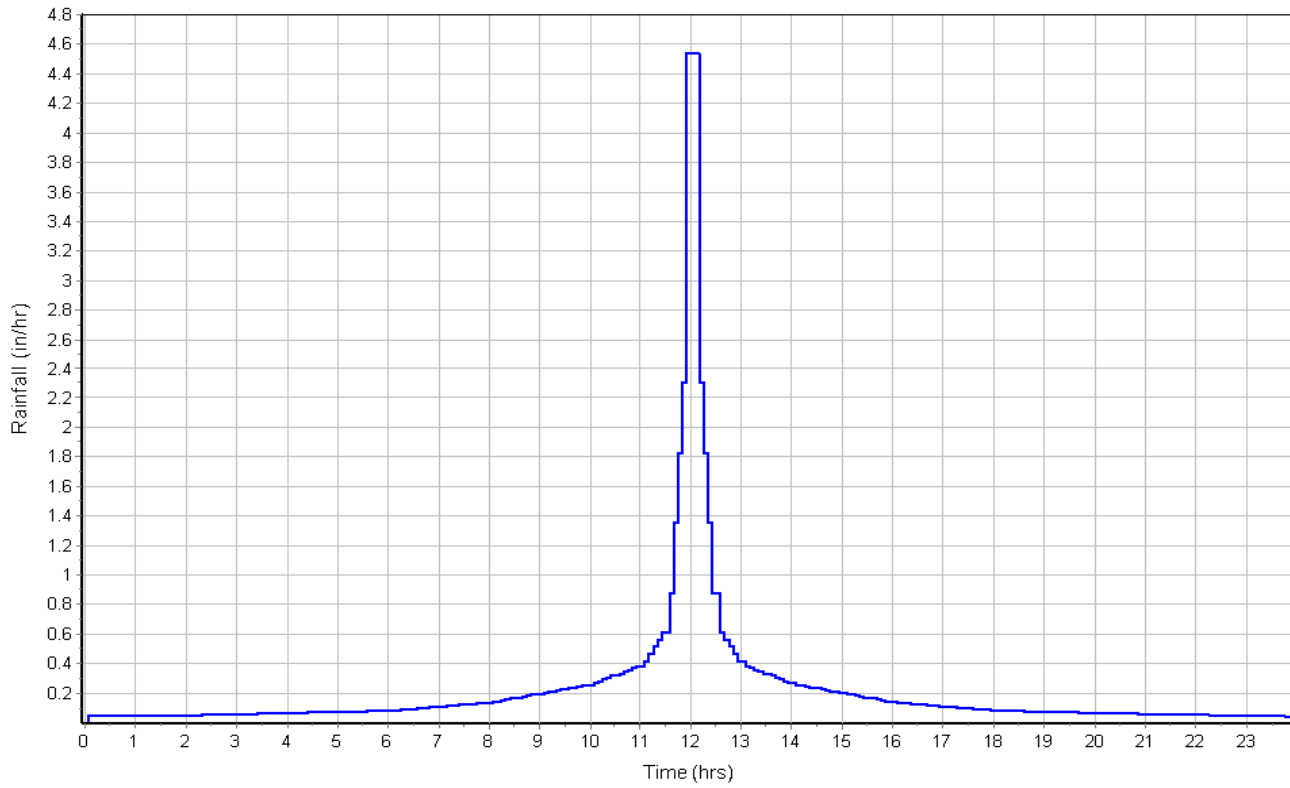

Runoff Hydrograph

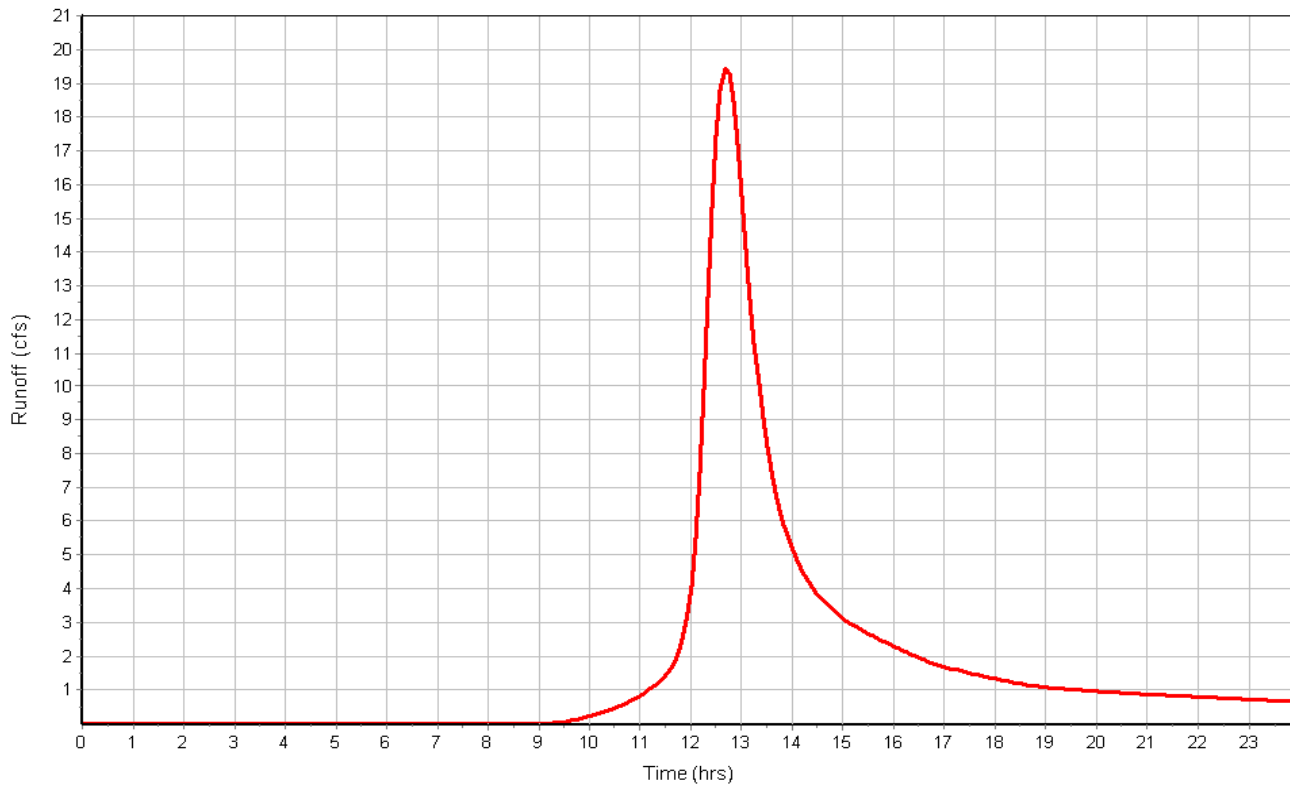

**Subbasin : C2**

**Input Data**

Area (ac) ..... 2.05  
 Weighted Curve Number ..... 82.98  
 Rain Gage ID ..... Rain Gage-01

**Composite Curve Number**

Soil/Surface Description	Area (acres)	Soil Group	Curve Number
> 75% grass cover, Good	0.32	D	80.00
> 75% grass cover, Good	0.76	C	74.00
Gravel roads	0.97	D	91.00
Composite Area & Weighted CN	2.05		82.98

**Time of Concentration**

	Subarea		
	A	B	C
<b>Sheet Flow Computations</b>			
Manning's Roughness :	.01	0.00	0.00
Flow Length (ft) :	60	0.00	0.00
Slope (%) :	2	0.00	0.00
2 yr, 24 hr Rainfall (in) :	3.00	0.00	0.00
Velocity (ft/sec) :	1.30	0.00	0.00
Computed Flow Time (min) :	0.77	0.00	0.00
<b>Channel Flow Computations</b>			
Manning's Roughness :	.03	0.00	0.00
Flow Length (ft) :	2256	0.00	0.00
Channel Slope (%) :	.5	0.00	0.00
Cross Section Area (ft <sup>2</sup> ) :	2.475	0.00	0.00
Wetted Perimeter (ft) :	6.91	0.00	0.00
Velocity (ft/sec) :	1.77	0.00	0.00
Computed Flow Time (min) :	21.23	0.00	0.00
Total TOC (min) .....	22.00		

**Subbasin Runoff Results**

Total Rainfall (in) ..... 5.40  
 Total Runoff (in) ..... 3.54  
 Peak Runoff (cfs) ..... 5.50  
 Weighted Curve Number ..... 82.98  
 Time of Concentration (days hh:mm:ss) ..... 0 00:22:00

Subbasin : C2

Rainfall Intensity Graph

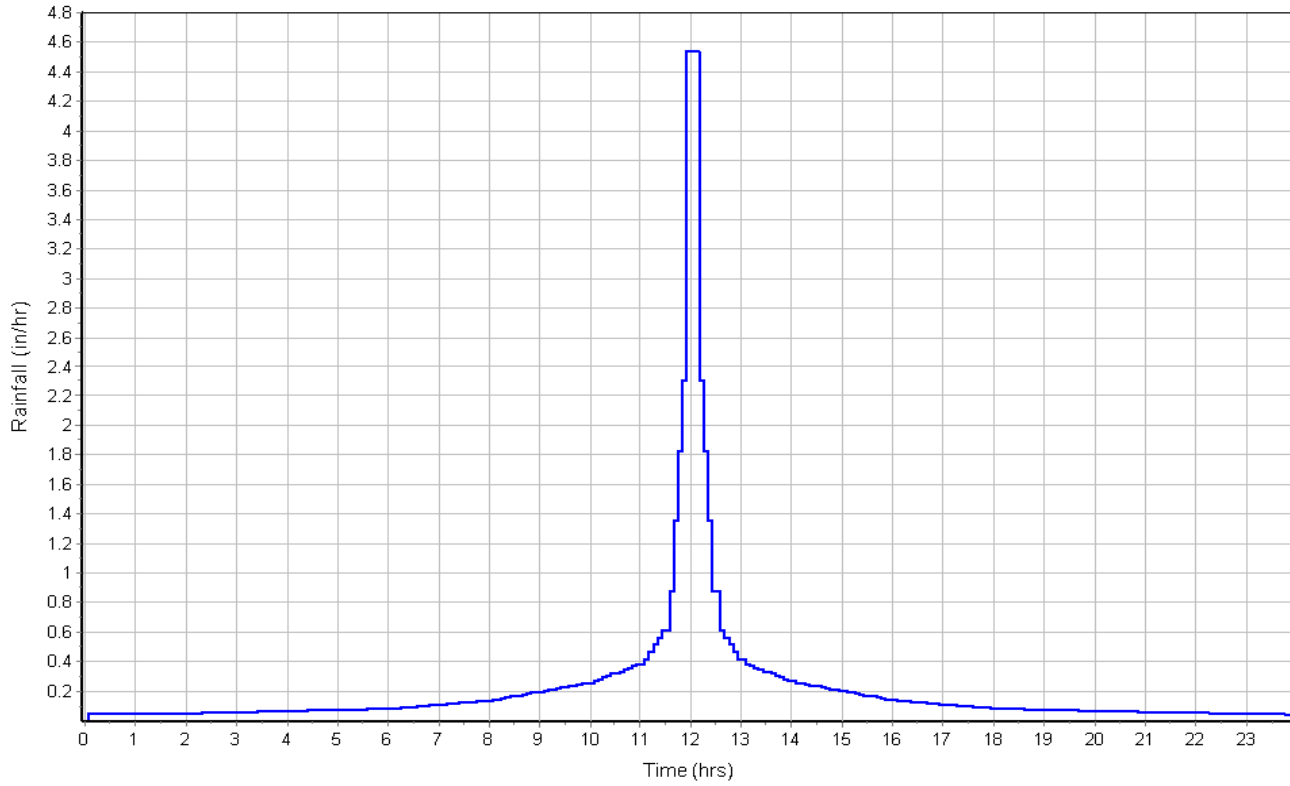

Runoff Hydrograph

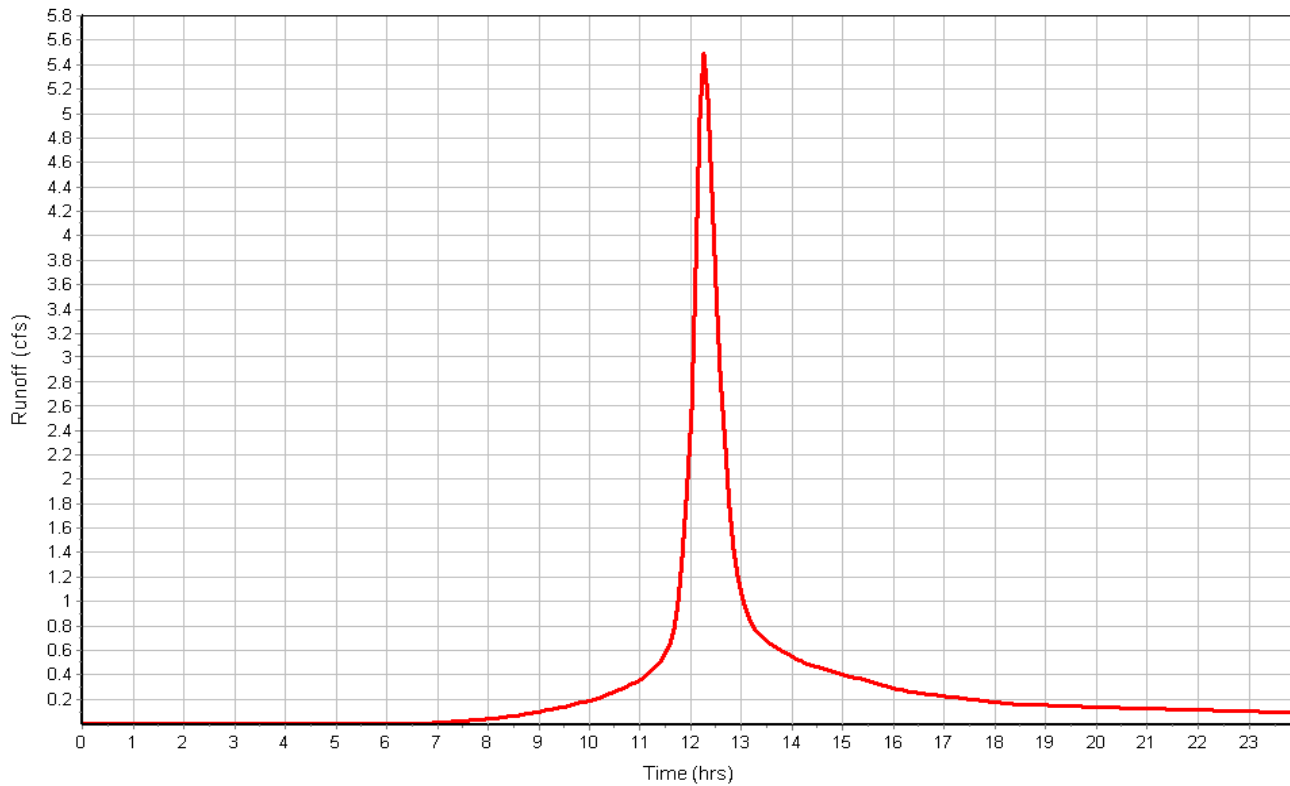

**Subbasin : D**

**Input Data**

Area (ac) ..... 0.59  
 Weighted Curve Number ..... 77.00  
 Rain Gage ID ..... Rain Gage-01

**Composite Curve Number**

Soil/Surface Description	Area (acres)	Soil Group	Curve Number
Woods, Good	0.59	D	77.00
Composite Area & Weighted CN	0.59		77.00

**Time of Concentration**

Sheet Flow Computations	Subarea A	Subarea B	Subarea C
	Manning's Roughness :	.6	0.00
Flow Length (ft) :	100	0.00	0.00
Slope (%) :	21	0.00	0.00
2 yr, 24 hr Rainfall (in) :	3.00	0.00	0.00
Velocity (ft/sec) :	0.14	0.00	0.00
Computed Flow Time (min) :	11.98	0.00	0.00

Shallow Concentrated Flow Computations	Subarea A	Subarea B	Subarea C
	Flow Length (ft) :	16	0.00
Slope (%) :	14.5	0.00	0.00
Surface Type :	Woodland	Unpaved	Unpaved
Velocity (ft/sec) :	1.90	0.00	0.00
Computed Flow Time (min) :	0.14	0.00	0.00
Total TOC (min) .....	12.12		

**Subbasin Runoff Results**

Total Rainfall (in) ..... 5.40  
 Total Runoff (in) ..... 2.96  
 Peak Runoff (cfs) ..... 1.61  
 Weighted Curve Number ..... 77.00  
 Time of Concentration (days hh:mm:ss) ..... 0 00:12:07

Subbasin : D

Rainfall Intensity Graph

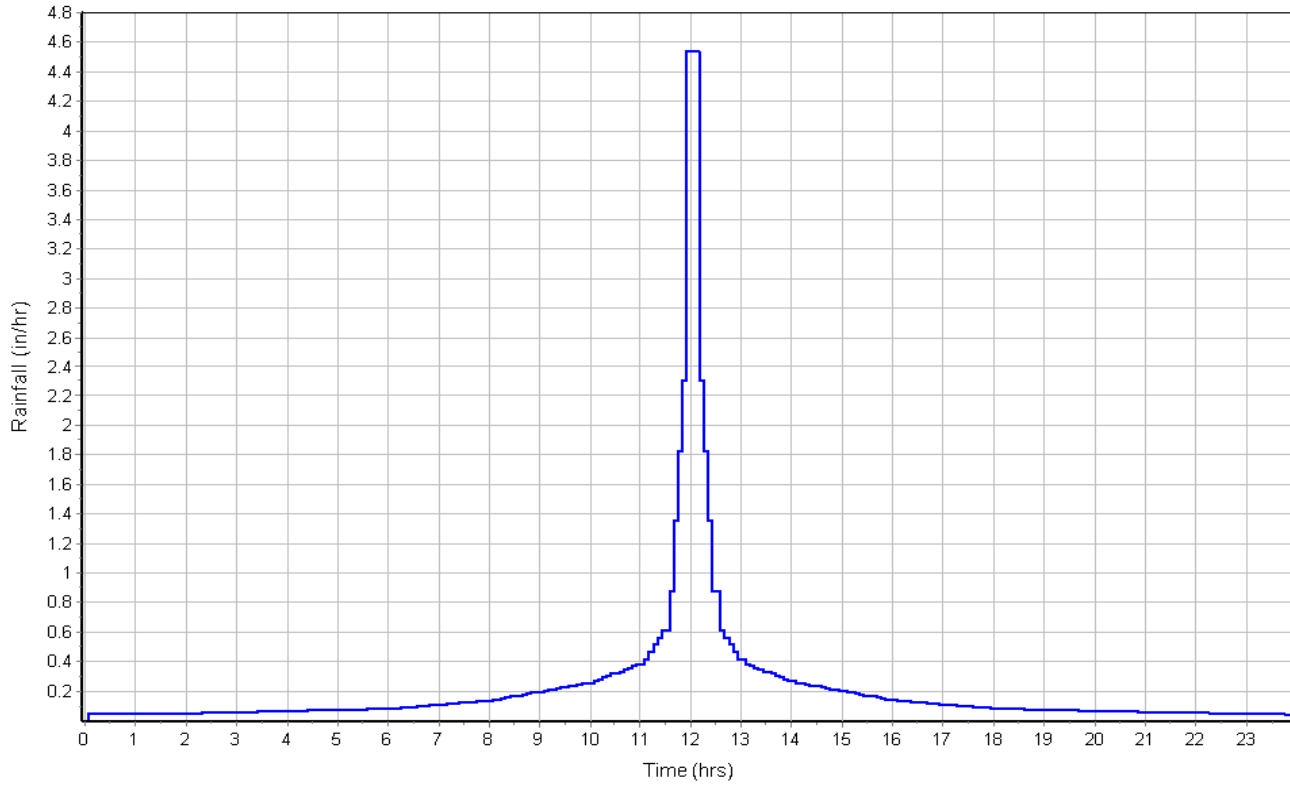

Runoff Hydrograph

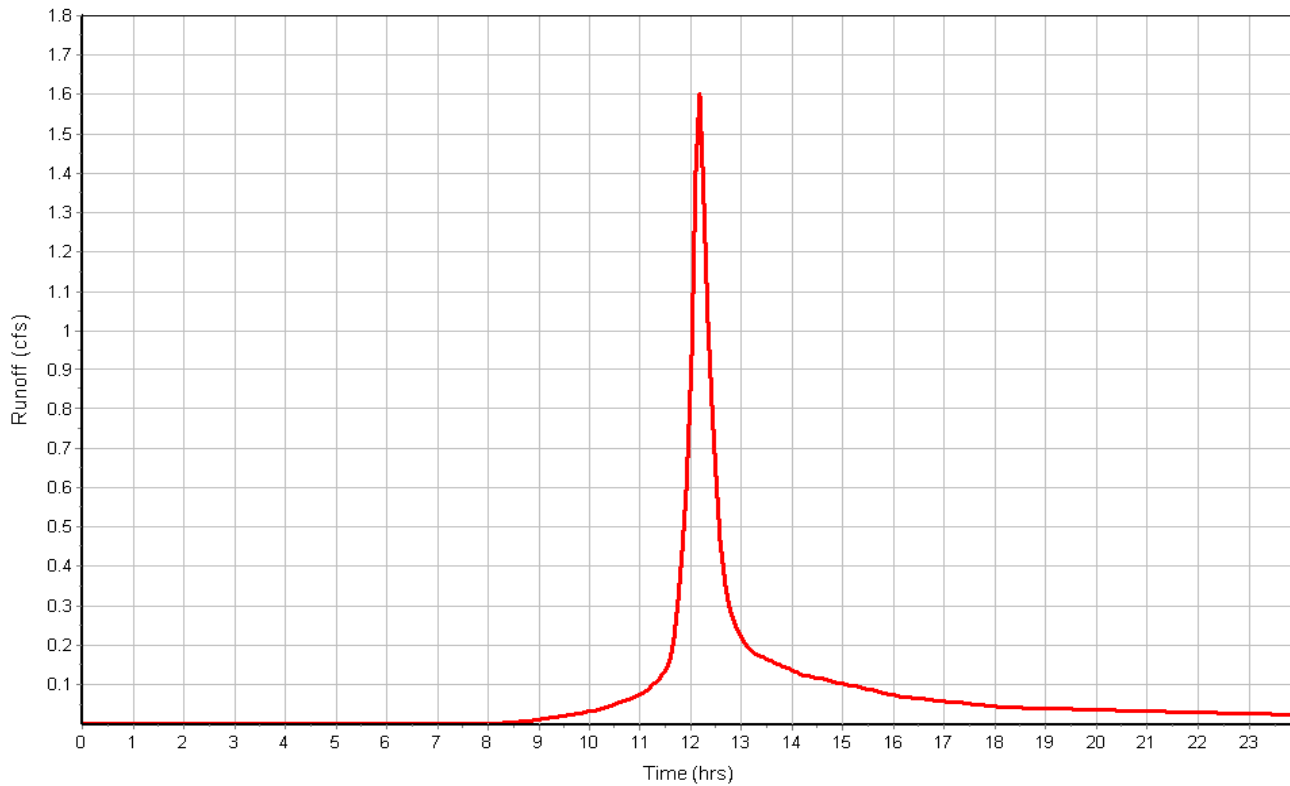

**Subbasin : E**

**Input Data**

Area (ac) ..... 2.86  
 Weighted Curve Number ..... 77.00  
 Rain Gage ID ..... Rain Gage-01

**Composite Curve Number**

Soil/Surface Description	Area (acres)	Soil Group	Curve Number
Woods, Good	2.86	D	77.00
Composite Area & Weighted CN	2.86		77.00

**Time of Concentration**

Sheet Flow Computations	Subarea A	Subarea B	Subarea C
	Manning's Roughness :	.6	0.00
Flow Length (ft) :	100	0.00	0.00
Slope (%) :	24	0.00	0.00
2 yr, 24 hr Rainfall (in) :	3.00	0.00	0.00
Velocity (ft/sec) :	0.15	0.00	0.00
Computed Flow Time (min) :	11.35	0.00	0.00

Shallow Concentrated Flow Computations	Subarea A	Subarea B	Subarea C
	Flow Length (ft) :	227	0.00
Slope (%) :	18	0.00	0.00
Surface Type :	Woodland	Unpaved	Unpaved
Velocity (ft/sec) :	2.12	0.00	0.00
Computed Flow Time (min) :	1.78	0.00	0.00
Total TOC (min) .....	13.14		

**Subbasin Runoff Results**

Total Rainfall (in) ..... 5.40  
 Total Runoff (in) ..... 2.96  
 Peak Runoff (cfs) ..... 7.65  
 Weighted Curve Number ..... 77.00  
 Time of Concentration (days hh:mm:ss) ..... 0 00:13:08

**Subbasin : E**

**Rainfall Intensity Graph**

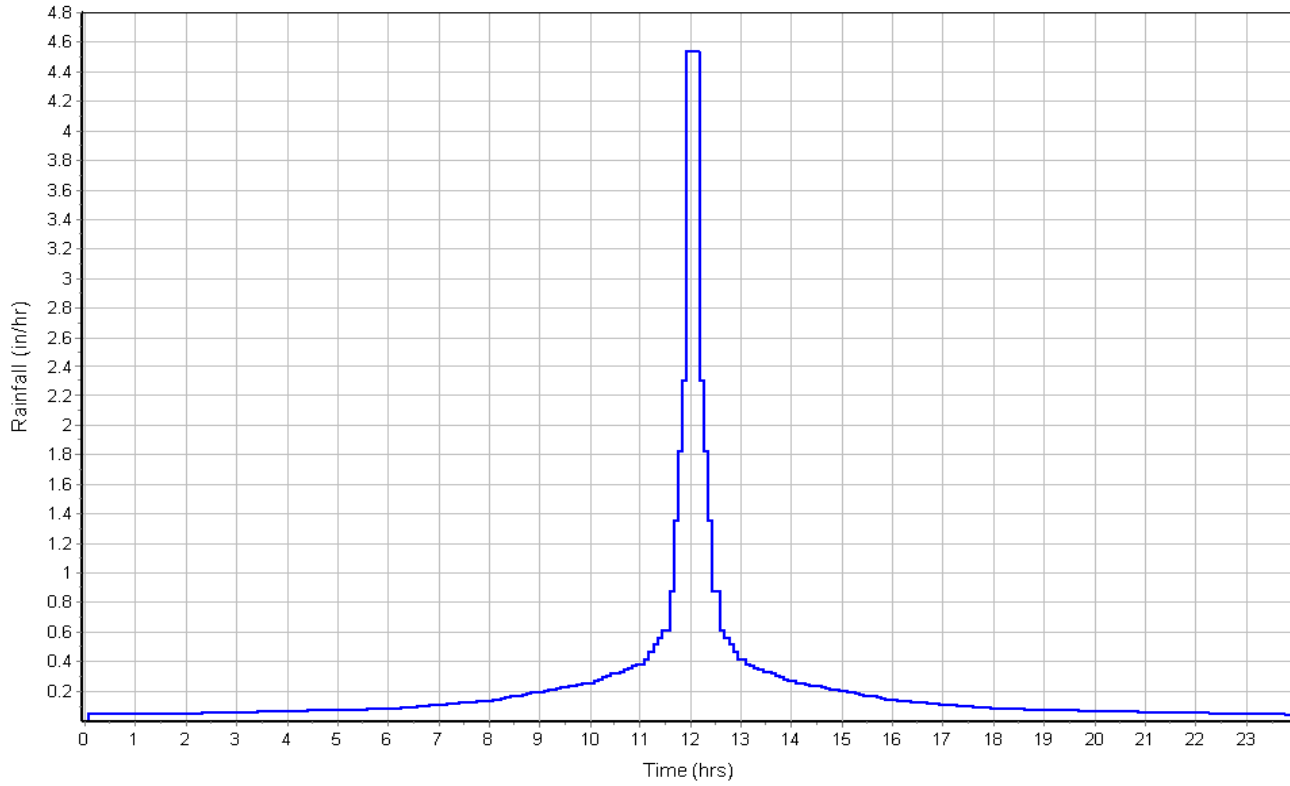

**Runoff Hydrograph**

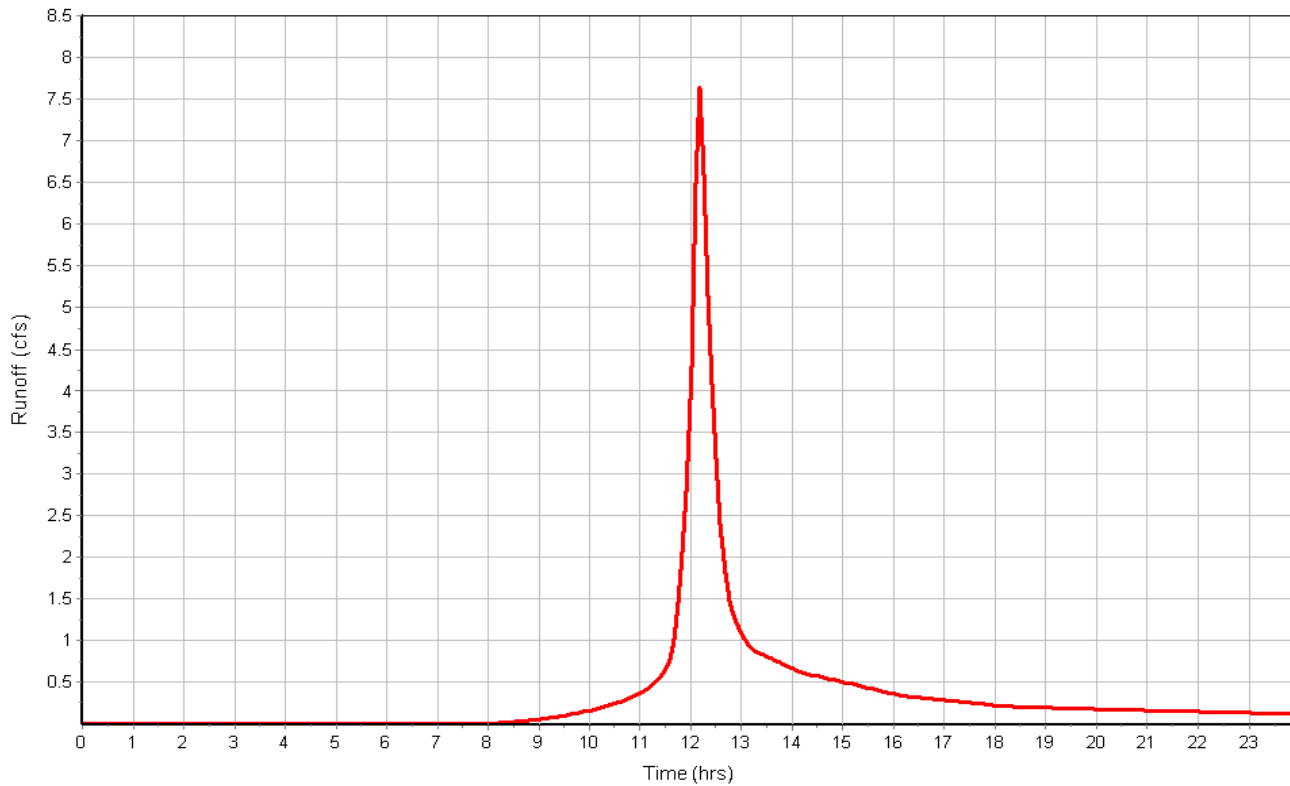

## Junction Input

Element ID	Invert Elevation (ft)	Ground/Rim (Max) Elevation (ft)
CB1	305.30	310.33
CB2	312.00	316.00
OUTLET-STR-A2	305.60	312.00
OUTLET-STR-C2	299.00	305.00



## Junction Results

Element ID	Peak Inflow	Max HGL Elevation Attained	Max HGL Depth Attained	Min Freeboard Attained	Average HGL Elevation Attained	Time of Max HGL Occurrence
	(cfs)	(ft)	(ft)	(ft)	(ft)	(days hh:mm)
CB1	15.49	307.02	1.72	3.31	305.63	0 12:29
CB2	19.59	313.26	1.26	2.74	312.17	0 12:15
OUTLET-STR-A2	6.77	306.50	0.90	5.50	305.81	0 12:16
OUTLET-STR-C2	0.28	299.15	0.15	5.85	299.07	0 13:31

## Pipe Input

Element ID	Length (ft)	Inlet Invert Elevation (ft)	Outlet Invert Elevation (ft)	Average Pipe Slope (%)	Pipe Shape	Pipe Diameter or Height (in)	Pipe Width (in)	Manning's Roughness
CULV-A	98.00	305.30	305.12	0.1800	CIRCULAR	36.000	36.000	0.0150
CULV-A2-1	104.00	312.00	310.00	1.9200	CIRCULAR	24.000	24.000	0.0150
CULV-A2-2	43.00	305.60	305.30	0.7000	CIRCULAR	24.000	24.000	0.0150
CULV-C2	40.00	299.00	298.00	2.5000	CIRCULAR	15.000	15.000	0.0150

## Pipe Results

Element ID	Peak Flow	Time of Peak Flow Occurrence	Design Flow Capacity	Peak Flow Velocity	Peak Flow Depth
	(cfs)	(days hh:mm)	(cfs)	(ft/sec)	(ft)
CULV-A	15.49	0 12:29	24.77	3.70	1.72
CULV-A2-1	19.52	0 12:15	27.19	9.43	1.26
CULV-A2-2	6.77	0 12:16	16.38	4.97	0.90
CULV-C2	0.28	0 13:31	8.85	3.28	0.15

## Storage Nodes

### Storage Node : DETENTION-A

#### Input Data

Invert Elevation (ft) ..... 309.50  
Max (Rim) Elevation (ft) ..... 312.00  
Max (Rim) Offset (ft) ..... 2.50  
Initial Water Elevation (ft) ..... 309.50  
Initial Water Depth (ft) ..... 0.00  
Ponded Area (ft<sup>2</sup>) ..... 0.00  
Evaporation Loss ..... 0.00

#### Storage Area Volume Curves

Storage Curve : Storage-08

Stage (ft)	Storage Area (ft <sup>2</sup> )	Storage Volume (ft <sup>3</sup> )
0	113	0.000
.5	15327	3860.00
1.2	18183.	15588.50
1.5	18635	21111.20
2.5	22257	41557.20

### Storage Area Volume Curves

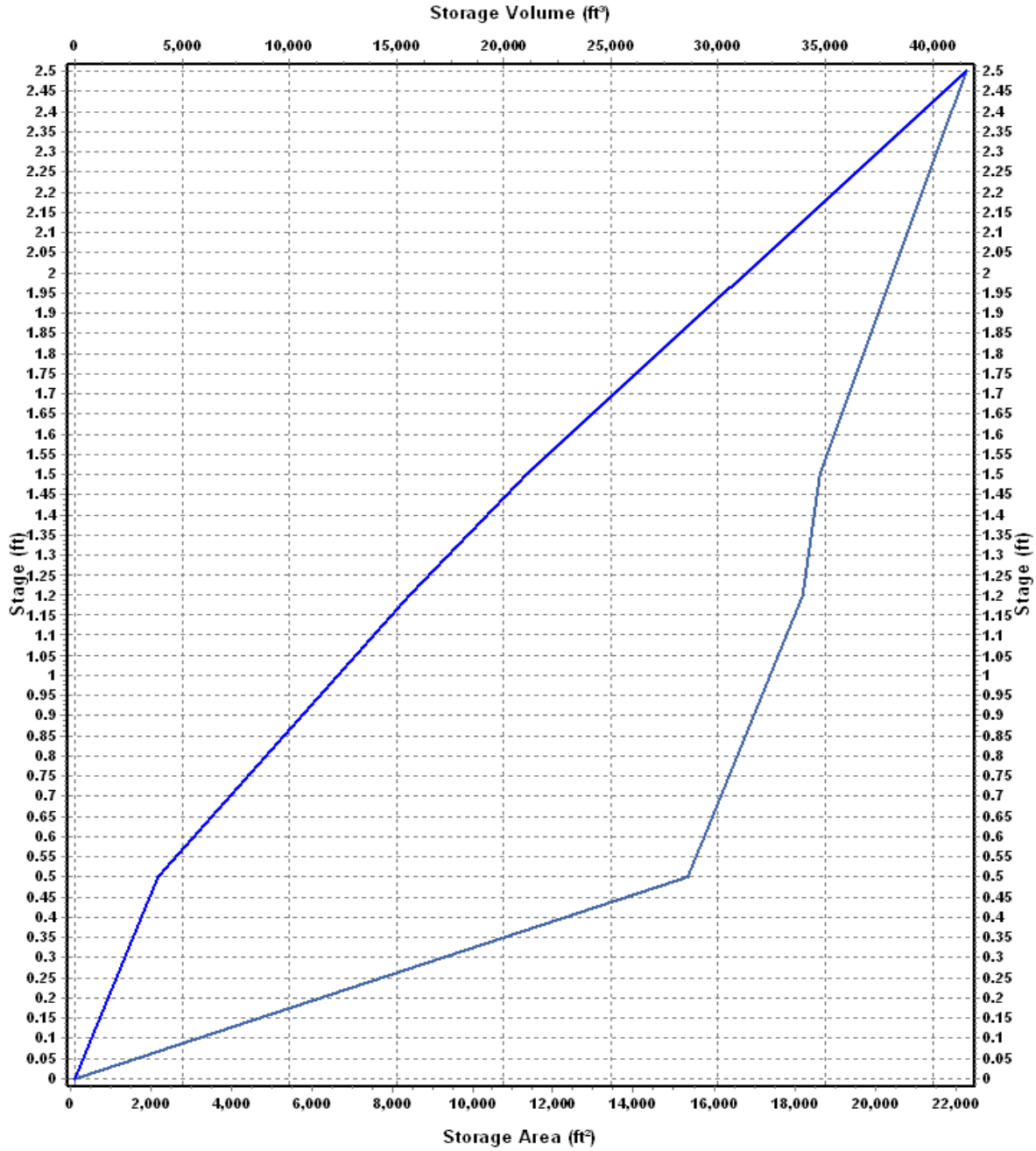

— Storage Area    — Storage Volume

**Storage Node : DETENTION-A (continued)**

**Outflow Orifices**

Element ID	Orifice Type	Orifice Shape	Circular Orifice Diameter (in)	Rectangular Orifice Height (in)	Rectangular Orifice Width (in)	Orifice Invert Elevation (ft)	Orifice Coefficient
BEEHIVE-GRATE	Bottom	CIRCULAR	18.17			310.33	0.61
ORIF-DET-A	Side	Rectangular		4.00	36.00	309.50	0.63

**Output Summary Results**

Peak Inflow (cfs) .....	21.62
Peak Lateral Inflow (cfs) .....	9.40
Peak Outflow (cfs) .....	9.01
Peak Exfiltration Flow Rate (cfm) .....	0.00
Max HGL Elevation Attained (ft) .....	310.72
Max HGL Depth Attained (ft) .....	1.22
Average HGL Elevation Attained (ft) .....	309.61
Average HGL Depth Attained (ft) .....	0.11
Time of Max HGL Occurrence (days hh:mm) .....	0 12:30
Total Exfiltration Volume (1000-ft <sup>3</sup> ) .....	0.000
Total Flooded Volume (ac-in) .....	0
Total Time Flooded (min) .....	0
Total Retention Time (sec) .....	0.00

**Storage Node : FILTER-A2**

**Input Data**

Invert Elevation (ft) .....	308.00
Max (Rim) Elevation (ft) .....	312.00
Max (Rim) Offset (ft) .....	4.00
Initial Water Elevation (ft) .....	309.50
Initial Water Depth (ft) .....	1.50
Ponded Area (ft <sup>2</sup> ) .....	0.00
Evaporation Loss .....	0.00

**Storage Area Volume Curves**

Storage Curve : Storage-05

Stage (ft)	Storage Area (ft <sup>2</sup> )	Storage Volume (ft <sup>3</sup> )
0	2178	0.000
1	4172	3175.00
2	5127	7824.50
3	6050	13413.00
4	7075	19975.50

### Storage Area Volume Curves

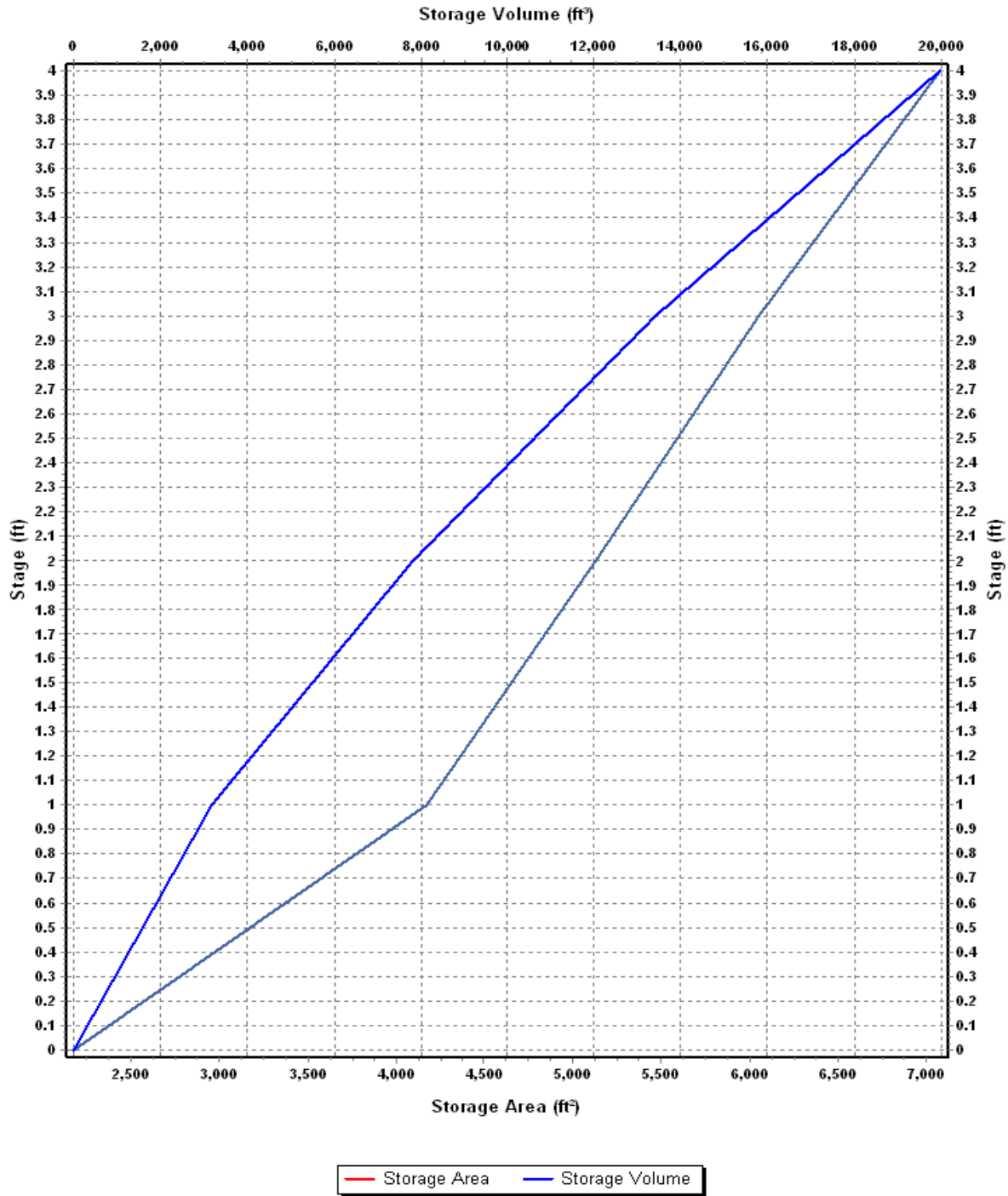



**Storage Node : FILTER-A2 (continued)**

**Outflow Weirs**

Element ID	Weir Type	Crest Elevation (ft)	Length (ft)	Weir Total Height (ft)	Discharge Coefficient
SPILLWAY-A2	Trapezoidal	310.70	40.00	1.30	3.10

**Outflow Orifices**

Element ID	Orifice Type	Orifice Shape	Circular Orifice Diameter (in)	Rectangular Orifice Height (in)	Rectangular Orifice Width (in)	Orifice Invert Elevation (ft)	Orifice Coefficient
ORIF-A2	Side	Rectangular		6.00	30.00	309.50	0.63

**Output Summary Results**

Peak Inflow (cfs) .....	19.52
Peak Lateral Inflow (cfs) .....	0.00
Peak Outflow (cfs) .....	19.21
Peak Exfiltration Flow Rate (cfm) .....	0.00
Max HGL Elevation Attained (ft) .....	310.91
Max HGL Depth Attained (ft) .....	2.91
Average HGL Elevation Attained (ft) .....	309.67
Average HGL Depth Attained (ft) .....	1.67
Time of Max HGL Occurrence (days hh:mm) .....	0 12:16
Total Exfiltration Volume (1000-ft <sup>3</sup> ) .....	0.000
Total Flooded Volume (ac-in) .....	0
Total Time Flooded (min) .....	0
Total Retention Time (sec) .....	0.00

**Storage Node : FILTER-C2**

**Input Data**

Invert Elevation (ft) ..... 301.50  
Max (Rim) Elevation (ft) ..... 305.00  
Max (Rim) Offset (ft) ..... 3.50  
Initial Water Elevation (ft) ..... 301.75  
Initial Water Depth (ft) ..... 0.25  
Ponded Area (ft<sup>2</sup>) ..... 0.00  
Evaporation Loss ..... 0.00

**Storage Area Volume Curves**

Storage Curve : Storage-07

Stage (ft)	Storage Area (ft <sup>2</sup> )	Storage Volume (ft <sup>3</sup> )
0	3380	0.000
.5	6601	2495.25
1.5	8462	10026.75
2.5	10125	19320.25
3.5	11092	29928.75

### Storage Area Volume Curves

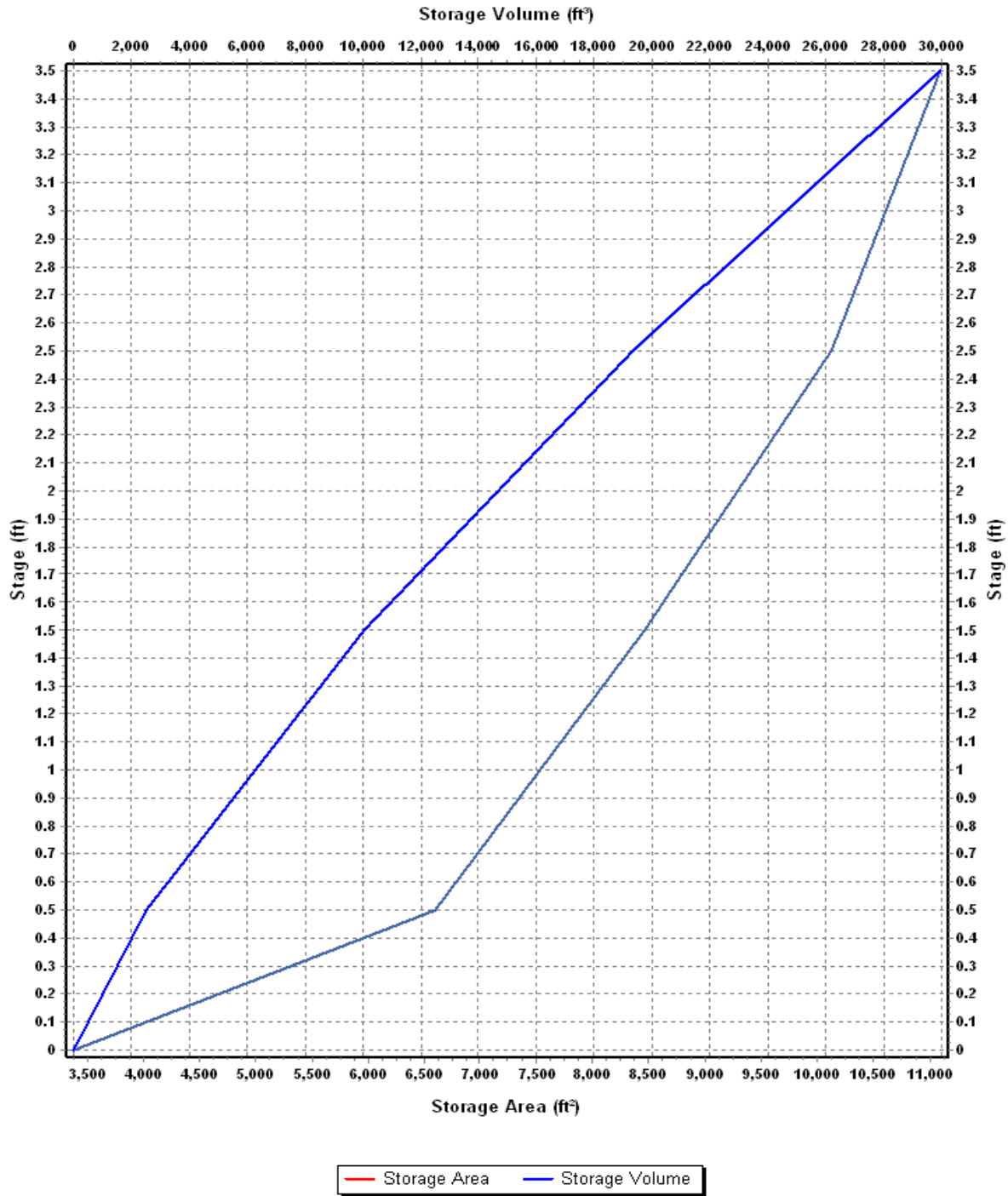

**Storage Node : FILTER-C2 (continued)**

**Outflow Weirs**

Element ID	Weir Type	Crest Elevation (ft)	Length (ft)	Weir Total Height (ft)	Discharge Coefficient
SPILLWAY-C2	Trapezoidal	303.80	30.00	1.20	3.10

**Outflow Orifices**

Element ID	Orifice Type	Orifice Shape	Circular Orifice Diameter (in)	Rectangular Orifice Height (in)	Rectangular Orifice Width (in)	Orifice Invert Elevation (ft)	Orifice Coefficient
ORIF-C2	Side	CIRCULAR	4.00			303.25	0.61

**Output Summary Results**

Peak Inflow (cfs) .....	5.49
Peak Lateral Inflow (cfs) .....	5.49
Peak Outflow (cfs) .....	0.69
Peak Exfiltration Flow Rate (cfm) .....	0.00
Max HGL Elevation Attained (ft) .....	303.83
Max HGL Depth Attained (ft) .....	2.33
Average HGL Elevation Attained (ft) .....	302.75
Average HGL Depth Attained (ft) .....	1.25
Time of Max HGL Occurrence (days hh:mm) .....	0 13:31
Total Exfiltration Volume (1000-ft <sup>3</sup> ) .....	0.000
Total Flooded Volume (ac-in) .....	0
Total Time Flooded (min) .....	0
Total Retention Time (sec) .....	0.00



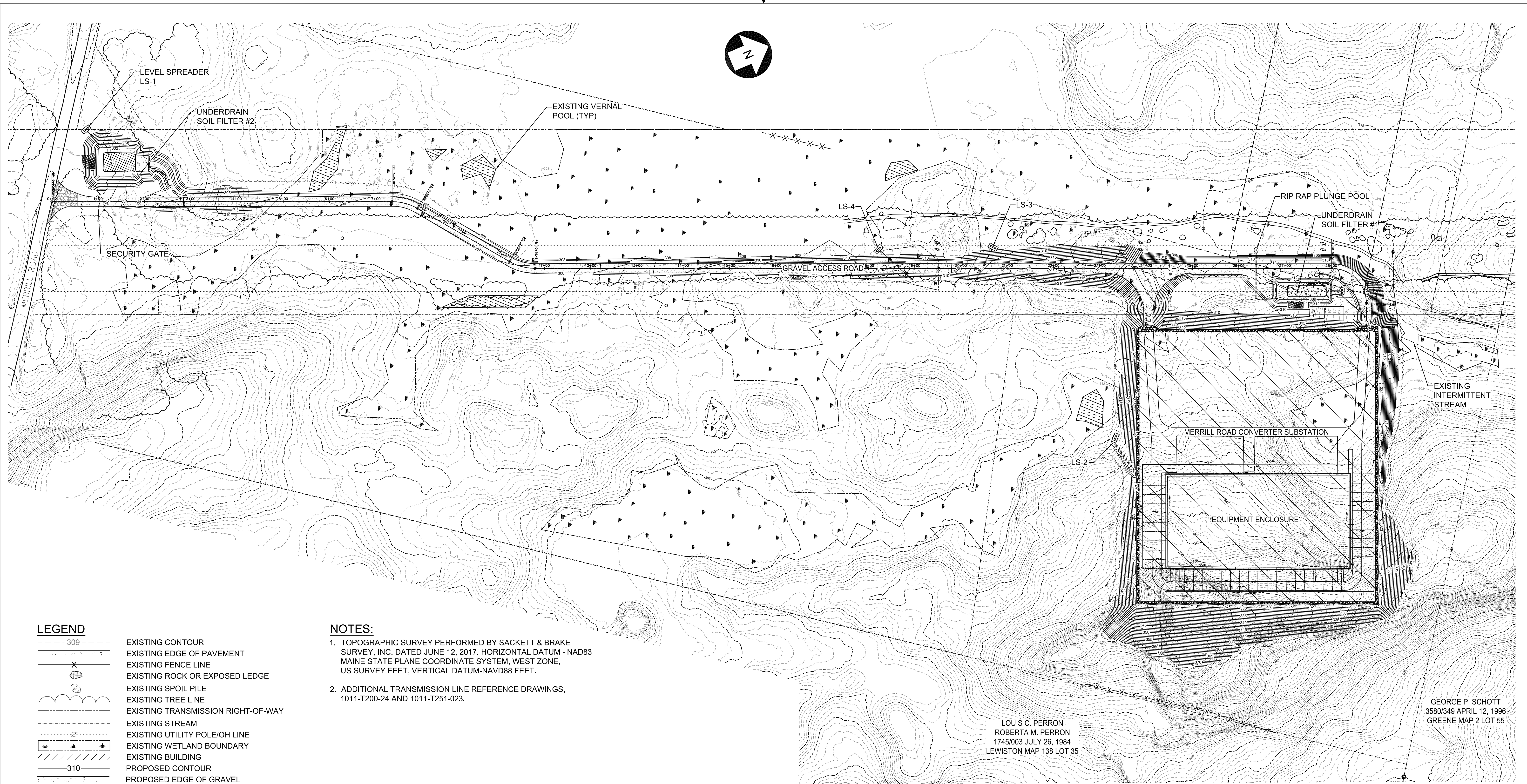

**LEGEND**

	EXISTING CONTOUR
	EXISTING EDGE OF PAVEMENT
	EXISTING FENCE LINE
	EXISTING ROCK OR EXPOSED LEDGE
	EXISTING SPOIL PILE
	EXISTING TREE LINE
	EXISTING TRANSMISSION RIGHT-OF-WAY
	EXISTING STREAM
	EXISTING UTILITY POLE/OH LINE
	EXISTING WETLAND BOUNDARY
	EXISTING BUILDING
	PROPOSED CONTOUR
	PROPOSED EDGE OF GRAVEL
	PROPOSED STABILIZED CONSTRUCTION EXIT
	PROPOSED FENCE LINE
	PROPOSED EDGE GRAVEL YARD SURFACE
	PROPOSED SITE LAYOUT POINT
	PROPOSED TREE LINE
	PROPOSED SILT FENCE
	PROPERTY LINE
	PROPOSED CHECK DAM
	PROPOSED BUILDING UNDERDRAIN

**NOTES:**

- TOPOGRAPHIC SURVEY PERFORMED BY SACKETT & BRAKE SURVEY, INC. DATED JUNE 12, 2017. HORIZONTAL DATUM - NAD83 MAINE STATE PLANE COORDINATE SYSTEM, WEST ZONE, US SURVEY FEET, VERTICAL DATUM-NAVD88 FEET.
- ADDITIONAL TRANSMISSION LINE REFERENCE DRAWINGS, 1011-T200-24 AND 1011-T251-023.

LOUIS C. PERRON  
ROBERTA M. PERRON  
1745/003 JULY 26, 1984  
LEWISTON MAP 138 LOT 35

GEORGE P. SCHOTT  
3580/349 APRIL 12, 1996  
GREENE MAP 2 LOT 55

**GENERAL SITE PLAN**  
SCALE: 1"= 100'

**ISSUED FOR REVIEW**  
**NOT FOR CONSTRUCTION**  
**05/29/18**

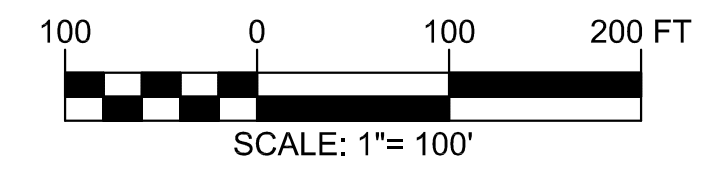

REV.	DESCRIPTION	DATE	BY	CK	APP
B	MEDEP PERMIT SET COMMENT REVISIONS	05/29/18	EVD	KRV	

OWNER ENGINEER:	APPROVAL STAMP:	PE Stamp
DRAWING PREPARED BY:	ACCEPTED BY OE:	

**USA ENGINEERING**  
CONFIDENTIAL, PROPRIETARY and TRADE SECRET INFORMATION  
Property of Iberdrola, USA

**GENERAL SITE PLAN**  
**PROPOSED CONDITIONS**  
SH 2 OF 2

MERRILL ROAD/1076      LEWISTON, ME

DR.	EVD	SCALE: 1"=100'	FILE: 1076-003-001SH002.DWG
CK.	KRV	NO.	
APP.			
DATE:			

1076-003-001      REV. B

ANSI D. CADD Drawing. DO NOT REVISE MANUALLY.



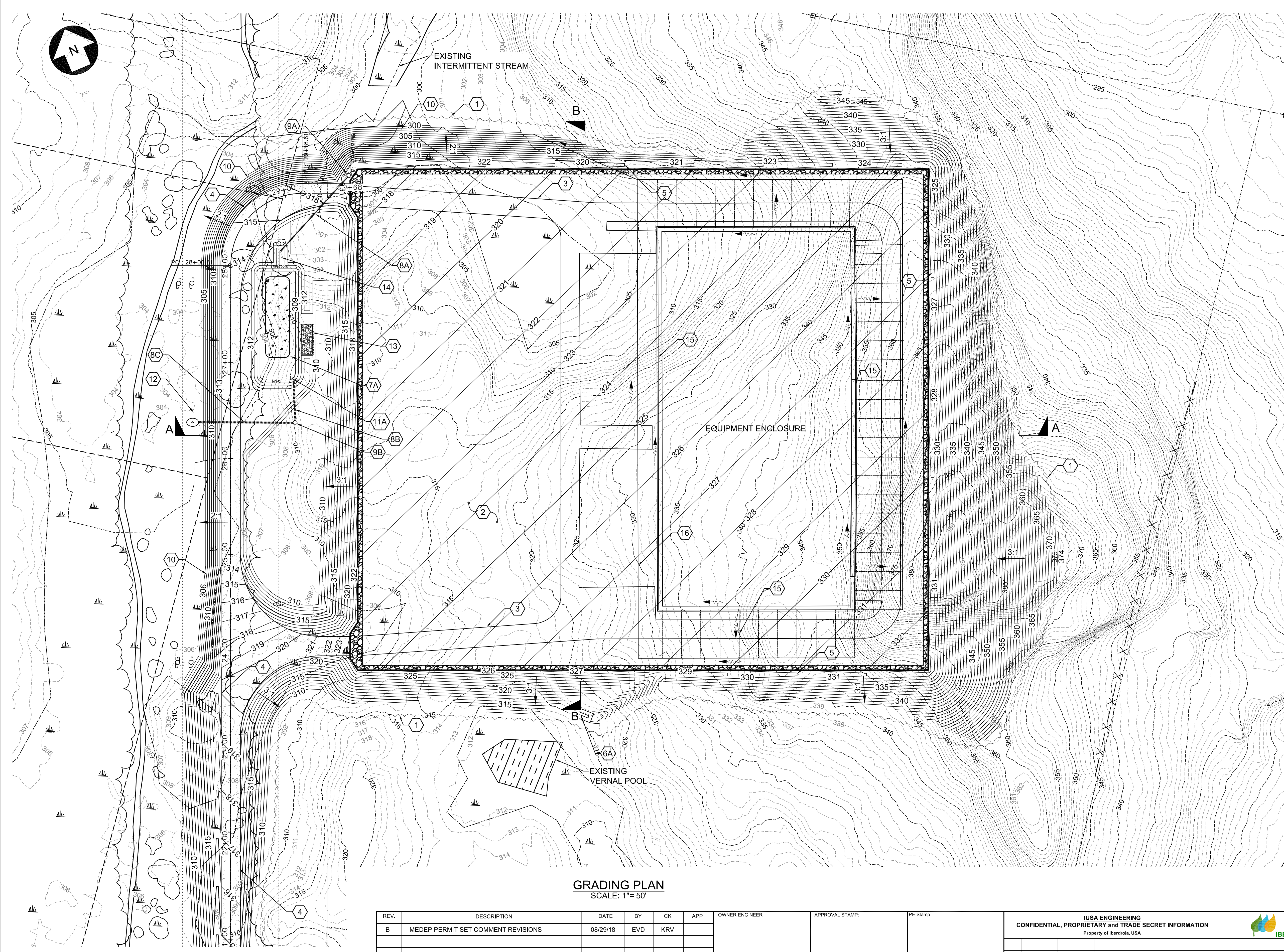

**LEGEND**

	EXISTING CONTOUR
	EXISTING EDGE OF PAVEMENT
	EXISTING FENCE LINE
	EXISTING ROCK OR EXPOSED LEDGE
	EXISTING SPOIL PILE
	EXISTING TREE LINE
	EXISTING TRANSMISSION RIGHT-OF-WAY
	EXISTING STREAM
	EXISTING UTILITY POLE/OH LINE
	EXISTING WETLAND BOUNDARY
	EXISTING BUILDING
	PROPOSED CONTOUR
	PROPOSED EDGE OF GRAVEL
	PROPOSED GRAVEL ACCESS RAMP
	PROPOSED FENCE LINE
	PROPOSED STABILIZED CONSTRUCTION EXIT
	PROPOSED SITE LAYOUT POINT
	PROPOSED TREE LINE
	PROPOSED SILT FENCE
	PROPERTY LINE
	PROPOSED CHECK DAM
	PROPOSED EDGE OF PAVEMENT

**NOTES:**

- TOPOGRAPHIC SURVEY PERFORMED BY SACKETT & BRAKE SURVEY, INC. DATED JUNE 12, 2017. HORIZONTAL DATUM - NAD83 MAINE STATE PLANE COORDINATE SYSTEM, WEST ZONE, US SURVEY FEET, VERTICAL DATUM-NAVD88 FEET.
- ADDITIONAL TRANSMISSION LINE REFERENCE DRAWINGS, 1011-T200-24 AND 1011-T251-023.

- WORK NOTES**
- 1 PROPOSED TREE LINE.
  - 2 SUBSTATION YARD - SEE SECTION A-A & B-B, DWG 1076-003-005 SHEET 1.
  - 3 PAVED VEHICULAR CIRCULATION ROUTES - SEE DETAIL, DWG 1076-003-005 SHEET 1.
  - 4 GRAVEL ACCESS ROAD - SEE DETAIL, DWG 1076-003-005 SHEET 1.
  - 5 VEGETATED DRAINAGE SWALE - SEE DETAIL, DWG 1076-003-005 SHEET 1.
  - 6A LEVEL SPREADER LS-2 - SEE DETAIL, DWG 1076-003-005 SHEET 2.
  - 7A GRASSED UNDERDRAIN SOIL FILTER #1 - SEE DETAIL, DWG 1076-003-002 SHEET 2.
  - 8A 24" CULVERT PIPE - INV IN = 312.0', INV OUT = 310.0'
  - 8B 24" CULVERT PIPE - INV IN = 305.60', INV OUT = 305.30'
  - 8C 36" CULVERT PIPE - INV IN = 305.30', INV OUT = 305.00'
  - 9A CATCH BASIN, CB-2 - RIM ELEV. = 316.0', SEE DETAIL DWG 1076-003-002 SHEET 2.
  - 9B CATCH BASIN/SEDIMENT BASIN OUTLET STRUCTURE, CB-1 - SEE DETAIL DWG 1076-003-002 SHEET 2.
  - 10 ALL SLOPES GREATER THAN 3 TO 1 SHALL RECEIVE EROSION CONTROL BLANKET - SEE DETAIL DWG 1076-003-005 SHEET 4.
  - 11A SOIL FILTER OUTLET STRUCTURE #1 - SEE DETAIL, DWG. 1076-003-002 SHEET 2.
  - 12 RIP RAP PLUNGE POOL - SEE DETAIL, DWG. 1076-003-005 SHEET 2.
  - 13 EMERGENCY SPILLWAY - SEE DETAIL, DWG. 1076-003-002 SHEET 2.
  - 14 STONE FOREBAY - SEE DETAIL, DWG. 1076-003-002 SHEET 2.
  - 15 4" PERFORATED PVC UNDERDRAIN - SEE DETAIL, DWG. 1076-003-02 SHEET 2.
  - 16 4" SDR 35 PVC UNDERDRAIN - SEE DETAIL, DWG. 1076-003-02 SHEET 2.

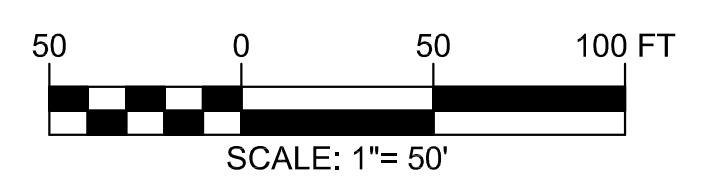

**GRADING PLAN**  
SCALE: 1"= 50'

REV.	DESCRIPTION	DATE	BY	CK	APP	OWNER ENGINEER:	APPROVAL STAMP:	PE Stamp
B	MEDEP PERMIT SET COMMENT REVISIONS	08/29/18	EVD	KRV				
						DRAWING PREPARED BY:	ACCEPTED BY OE:	

**USA ENGINEERING**  
CONFIDENTIAL, PROPRIETARY and TRADE SECRET INFORMATION  
Property of Iberdrola, USA

**CMP**  
IBERDROLA - USA

**GRADING PLAN**  
SH 1 OF 4  
MERRILL ROAD/1076  
LEWISTON, ME

DR.	EVD	SCALE: 1"=50'	FILE: 1076-003-002SH001.DWG		
CK.	KRV	NO.			
APP.					
REV.	DATE	BY	DESCRIPTION	APP.	DATE:

1076-003-002 B

**ISSUED FOR REVIEW**  
**NOT FOR CONSTRUCTION**  
**05/29/18**

ANSI D. CADD Drawings DO NOT REVISE MANUALLY.



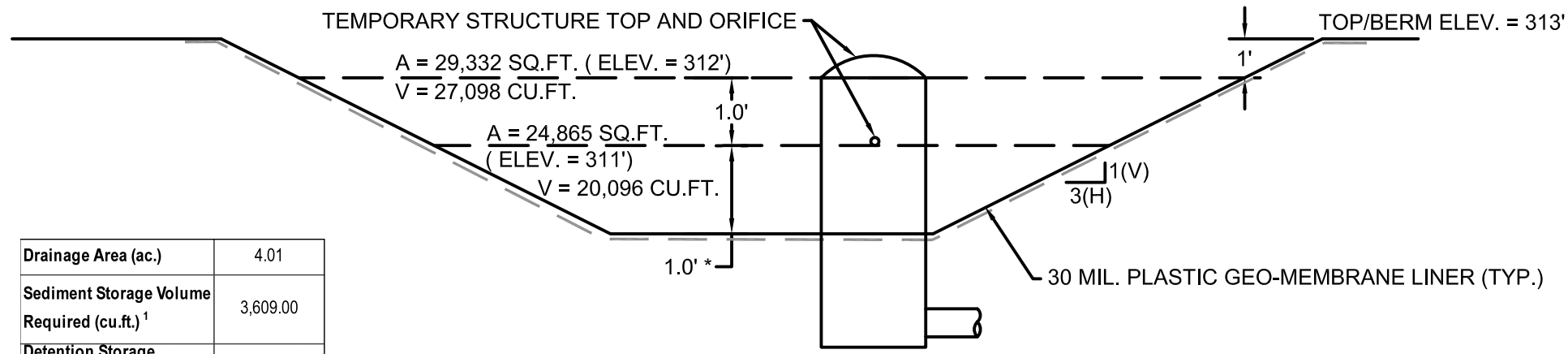

Drainage Area (ac)	4.01
Sediment Storage Volume Required (cu.ft.) <sup>1</sup>	3,609.00
Detention Storage Volume Required (cu.ft.) <sup>1</sup>	14,436.00
Sediment Storage Provided (cu.ft.)	20,096.00
Detention Storage Provided (cu.ft.)	27,098.50
Storm Event	10-year/24-hr
V <sub>max</sub> (ft.)	1.88
Q <sub>max</sub> (cfs)	7.30
Q <sub>max</sub> /DA (cfs/ac)	1.82
Q <sub>10</sub> /Q <sub>2</sub>	0.0250
Max Q <sub>outlet</sub> (cfs)	0.18
Orifice Diameter (in.)	2.00
Outflow Achieved (cfs)	0.16

**NOTES:**

CONVERT THE SEDIMENT BASIN TO A GRADED DEPRESSION WITH CATCH BASIN TOP AT GRADE BY LOWERING THE GRATE TOP FOLLOWING FINAL STABILIZATION

GRADE SEDIMENT BASIN AND SURROUNDING AREA TO FINISHED PLAN GRADES UP TO ELEVATION 312' (MIN.) PRIOR TO UPSTREAM DISTURBANCES

\* 1' OF STORAGE ASSUMED. ACTUAL PERMANENT GRATE ELEVATION = 310.0'

1. NRCS Conservation Practice Standard Code 350 - Sediment Basin  
2. Maine Erosion and Sediment Control BMPs (10/2016) Ch. 2 - Sediment Basins, Graph C.1

ELEVATION	AREA (SQ.FT)	INCR. VOLUME (CU.FT.)	TOTAL VOLUME (CU.FT.)
310.00	15,327.00		
311.00	24,865.00	20,096.00	20,096.00
312.00	29,332.00	27,098.50	47,194.50

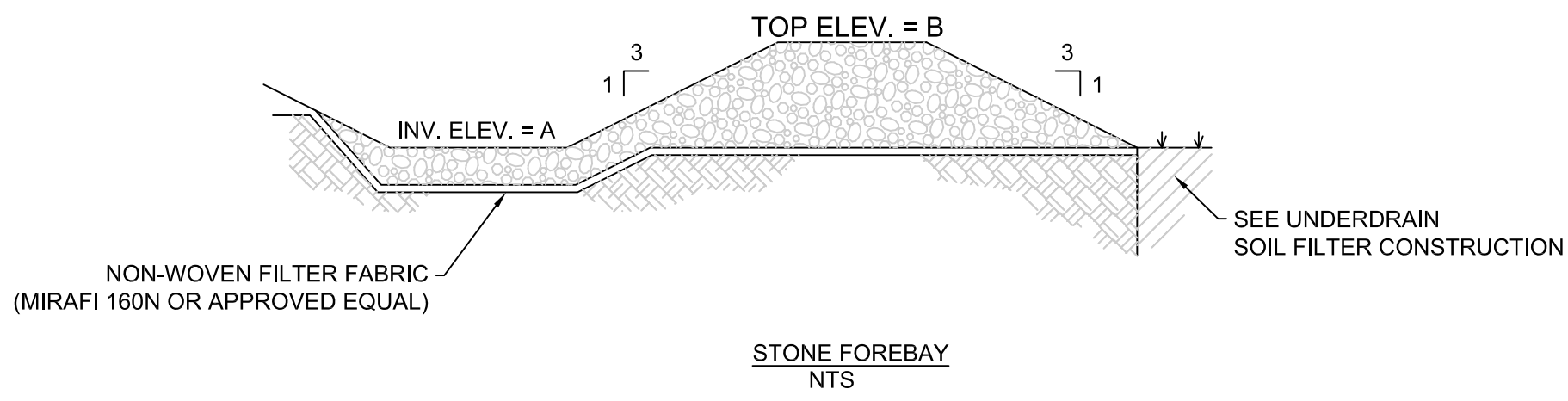

STONE FOREBAY ELEVATIONS		
UNDERDRAIN FILTER NUMBER	A	B
SOIL FILTER #1	310.0	310.5
SOIL FILTER #2	302.0	302.5

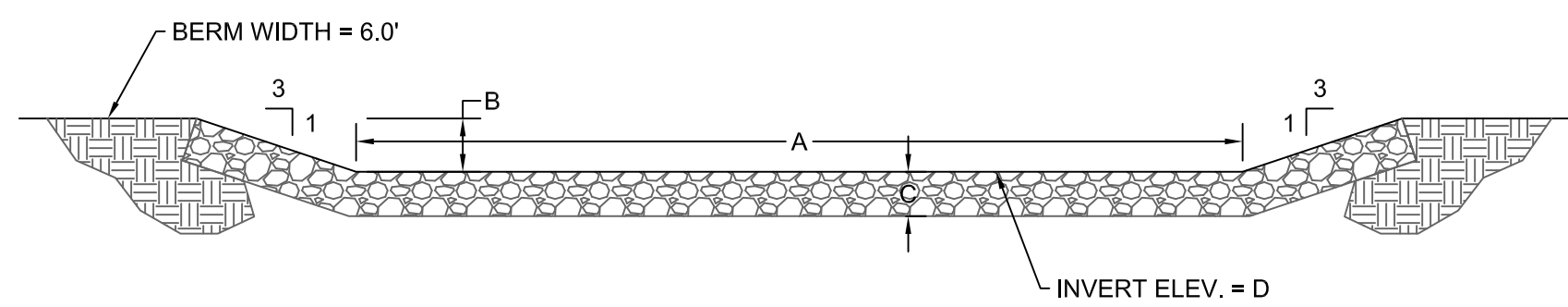

EMERGENCY SPILLWAY GEOMETRY						
UNDERDRAIN FILTER NUMBER	A	B	C	D	RIP RAP D50	25-YR WATER ELEV.
SOIL FILTER #1	40'	1.30'	18"	310.70	9"	310.93
SOIL FILTER #2	30'	1.20'	12"	303.80	6"	303.84

**FILTER NOTES:**

- UNDERDRAIN PIPES SHALL BE SCH. 40 PVC. ENDS OF UNDERDRAIN PIPING SHALL BE PLUGGED WITH PIPE FITTINGS. PIPE JOINTS SHALL BE FULLY GLUED.
- COMPACT EMBANKMENT MATERIAL TO 93% OF MAXIMUM DENSITY AS DETERMINED BY ASTM D1557.
- FILTER BED & SIDE SLOPES SHALL BE SEEDED USING "NEW ENGLAND CONSERVATION/WILDLIFE MIX" FROM NEW ENGLAND WETLAND PLANTS, INC. OF AMHERST, MA. OR APPROVED EQUAL (APPLICATION RATE 25#/ACRE).
- MDOT 703.22 UNDERDRAIN BACKFILL MATERIAL, TYPE B SPECIFICATIONS.

SIEVE	% BY WEIGHT
1	90-100
1/2	75-100
#4	50-100
#20	15-80
#50	0-15
#200	0-5

**5. FILTER MEDIA MATERIALS:**

- 5.1. FILTER TOPSOIL LAYER: A 6-INCH LAYER OF LOAMY TOPSOIL SUCH AS USDA SANDY LOAM TOPSOIL WITH 5-8% HUMIFIED ORGANIC MATTER. SCREENED TOPSOIL FROM THE SITE MAY BE APPROPRIATE BUT SHALL BE TESTED FOR ORGANIC CONTENT. ORGANIC MATTER (SUCH AS SUPERHUMUS OR EQUIVALENT) MAY BE ADDED IF NECESSARY, PROVIDED THAT THE RESULTING TEXTURE IS SUITABLE. SEE EROSION CONTROL DETAILS FOR EROSION CONTROL BLANKET INSTALLATION REQUIREMENTS.
- 5.2. FILTER SAND LAYER: A 12-INCH LAYER OF LOAMY COARSE SAND PER MAINE DEP STORMWATER BEST MANAGEMENT PRACTICES TABLE 7.1.3.

SIEVE	% BY WEIGHT
#10	85-100
#20	70-100
#60	15-40
#200	8-15
#200 (CLAY SIZE)	<2.0

**FILTER CONSTRUCTION INSPECTION AND TESTING NOTES:**

- INSPECTION OF THE FILTER BASIN SHALL BE PROVIDED FOR EACH PHASE OF CONSTRUCTION BY THE DESIGN ENGINEER WITH REQUIRED REPORTING TO THE MAINE DEP.
- AT A MINIMUM INSPECTIONS WILL OCCUR:
  - AFTER PRELIMINARY CONSTRUCTION OF THE FILTER GRADES AND ONCE THE UNDERDRAIN PIPES ARE INSTALLED BUT NOT BACKFILLED;
  - AFTER THE DRAINAGE LAYER IS CONSTRUCTED AND PRIOR TO THE INSTALLATION OF THE FILTER SAND LAYER;
  - AFTER FILTER SAND LAYER IS CONSTRUCTED AND PRIOR TO THE INSTALLATION OF THE FILTER TOPSOIL LAYER;
  - AFTER THE FILTER TOPSOIL LAYER HAS BEEN INSTALLED AND SEEDING; AND
  - AFTER ONE YEAR TO INSPECT HEALTH OF THE VEGETATION AND MAKE CORRECTIONS.
- THE CONTRACTOR SHALL PROVIDE SUBMITTALS FOR EACH COMPONENT OF THE FILTER MEDIA, IDENTIFYING THE SOURCE.
- ALL MATERIAL USED FOR THE CONSTRUCTION OF THE FILTER BASIN WILL BE APPROVED BY THE DESIGN ENGINEER, AFTER TESTS BY A CERTIFIED LABORATORY SHOW THAT THEY ARE PASSING MAINE DEP SPECIFICATIONS.
- THE CONTRACTOR SHALL SUBMIT SAMPLES OF EACH TYPE OF MATERIAL TO BE USED FOR THE MIXED FILTER MEDIA AND SAMPLES OF THE UNDERDRAIN BEDDING MATERIAL. SAMPLES MUST BE A COMPOSITE OF THREE DIFFERENT LOCATIONS (GRABS) FROM THE STOCKPILE OR PIT FACE. SAMPLE SIZE REQUIRED WILL BE DETERMINED BY THE TESTING LABORATORY.
- THE CONTRACTOR SHALL PERFORM, OR HAVE PERFORMED, A SIEVE ANALYSIS CONFORMING TO ASTM C138 ON EACH TYPE OF THE SAMPLE MATERIAL. ALL MATERIALS SHALL HAVE A CLAY CONTENT OF LESS THAN 2% AS DETERMINED BY HYDROMETER GRAIN SIZE ANALYSIS.
- THE CONTRACTOR SHALL PERFORM, OR HAVE PERFORMED, A PERMEABILITY TEST ON THE SOIL FILTER MEDIA MATERIALS CONFORMING TO ASTM D2434 WITH THE MIXTURE COMPACTED TO 90 - 92% OF MAXIMUM DRY DENSITY BASED ON ASTM D698.

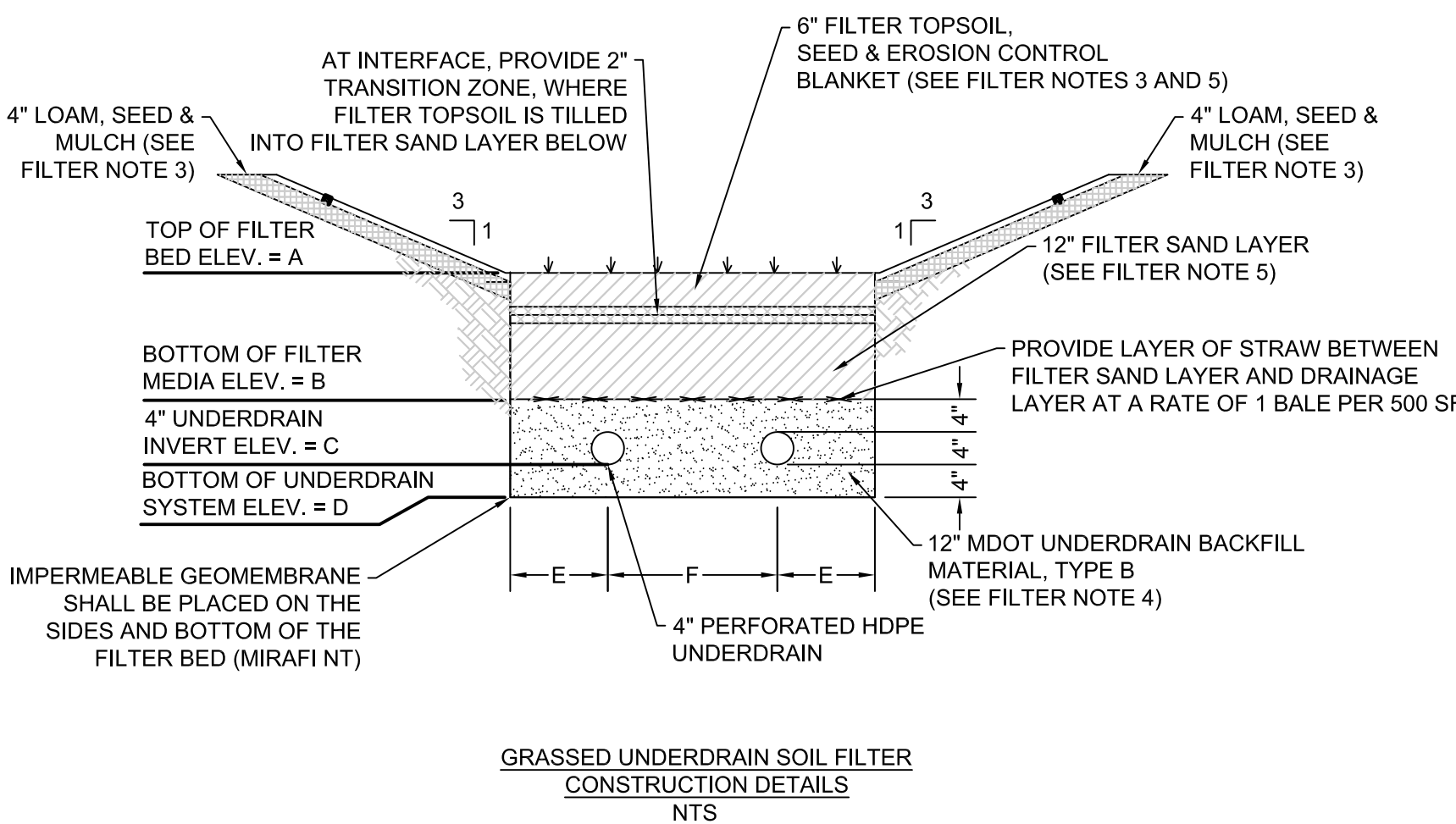
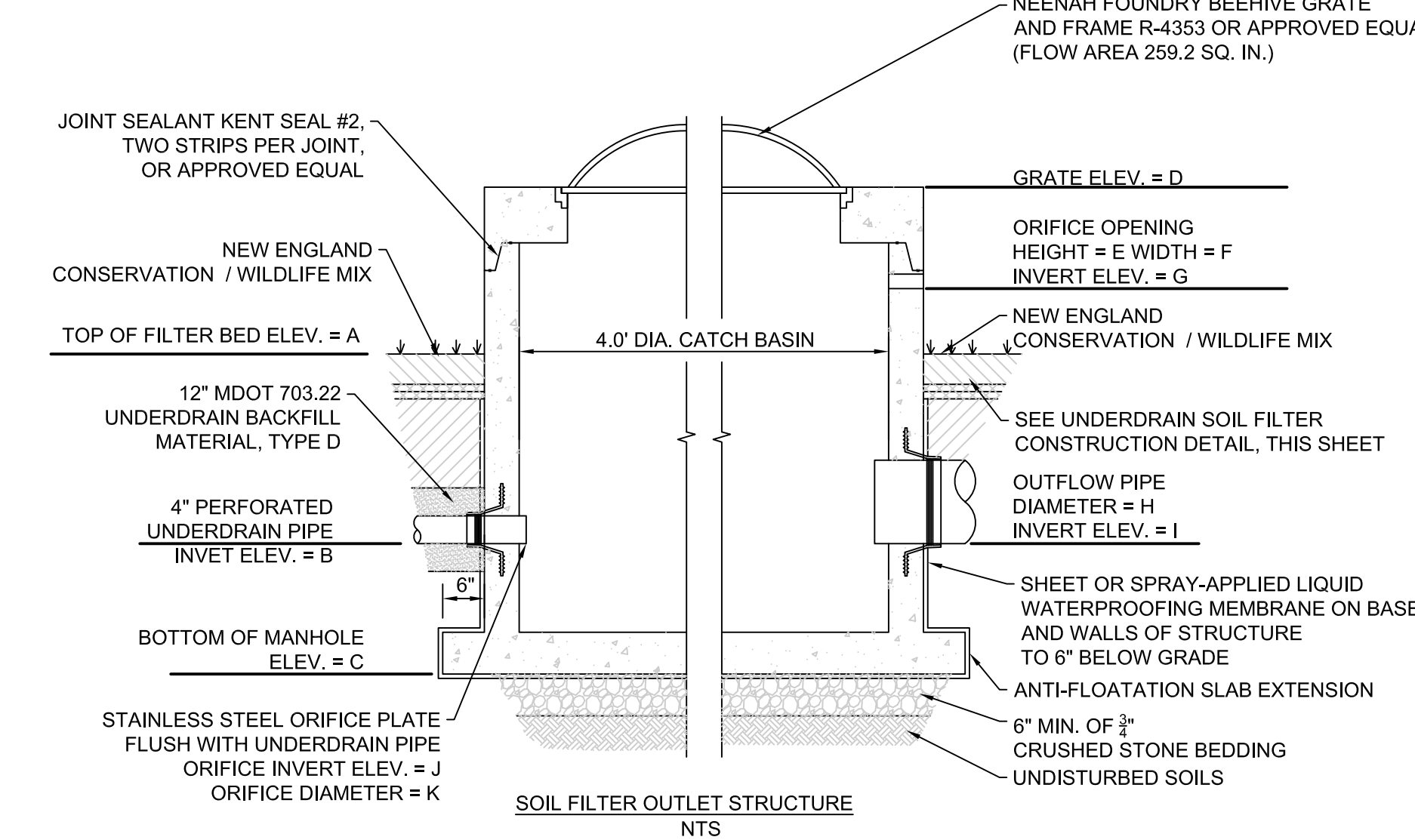
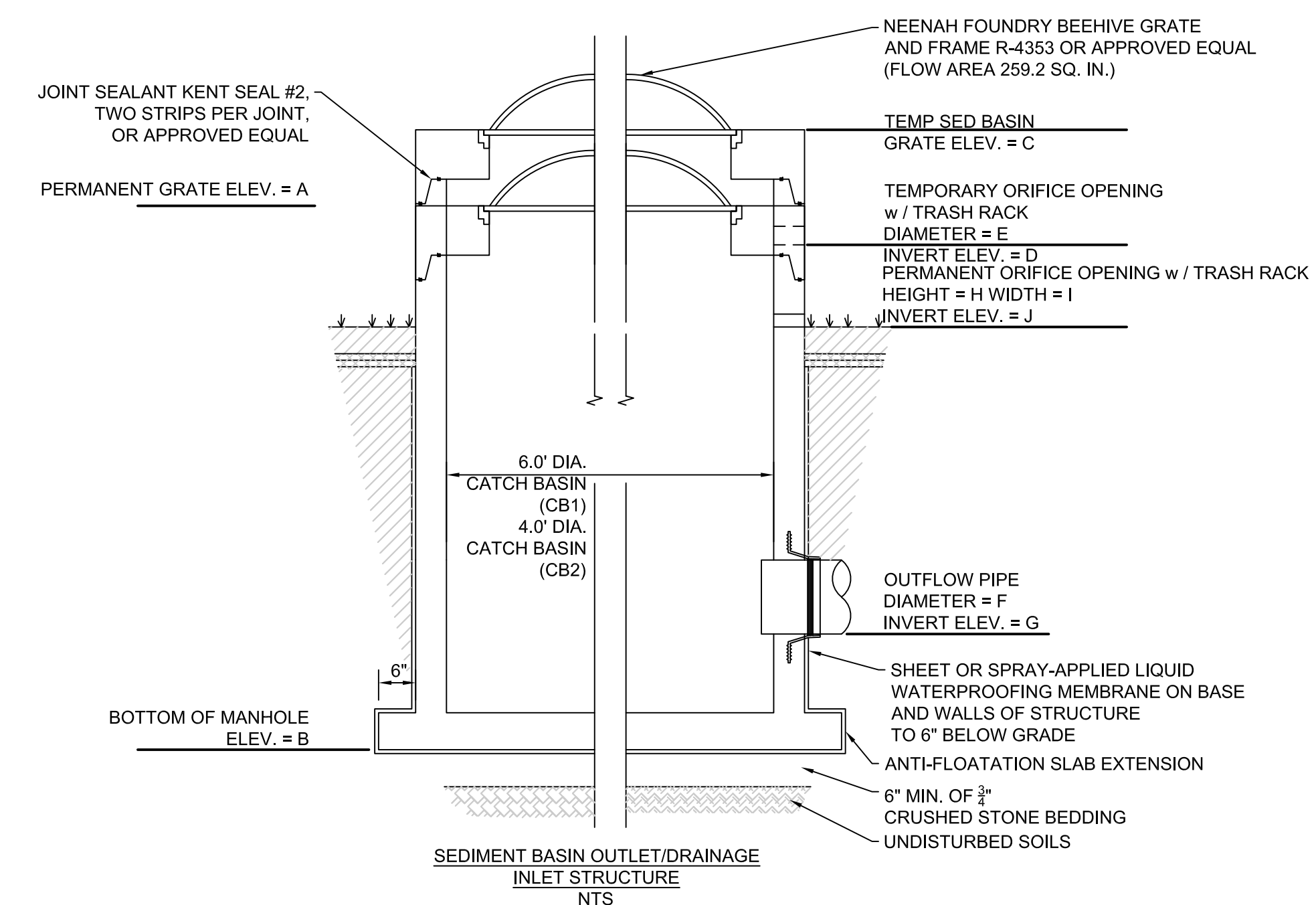
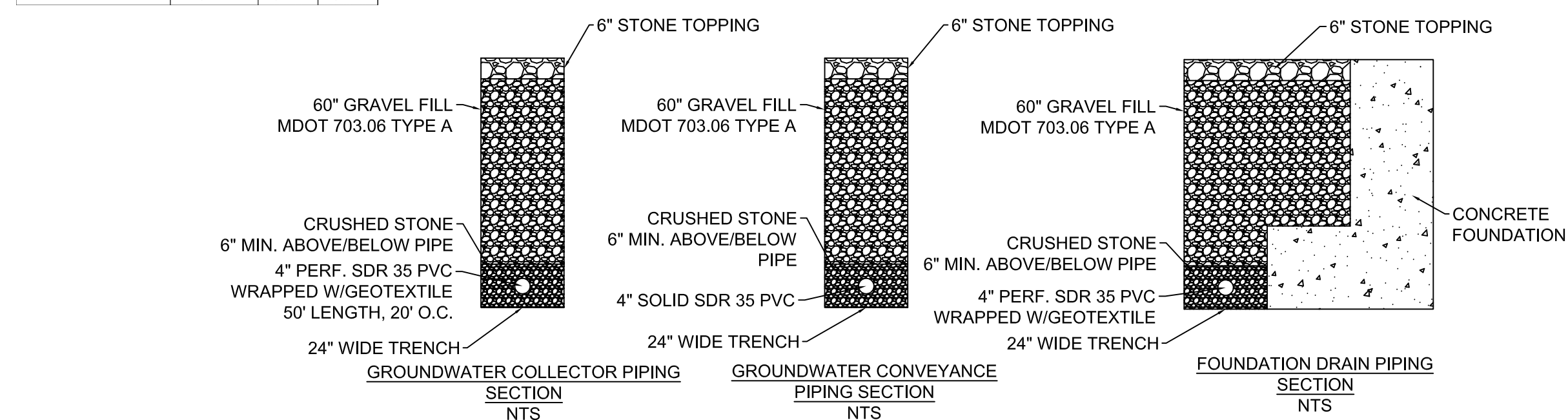

GRASSED UNDERDRAIN SOIL FILTER ELEVATIONS/GEOMETRY						
UNDERDRAIN FILTER NUMBER	A	B	C	D	E	F
SOIL FILTER #1	308.00	306.33	305.66	305.33	7.00	11.00
SOIL FILTER #2	301.50	299.83	299.16	298.83	7.00	11.00

NOTE: FILTER CROSS SECTION IS SHOWN FOR GRAPHICAL PURPOSES ONLY - NOT TRUE SCALE.

SOIL FILTER OUTLET STRUCTURE ELEVATIONS/GEOMETRY												
UNDERDRAIN FILTER NUMBER	A	B	C	D	E	F	G	H	I	J	K	
SOIL FILTER #1	308.00	305.66	304.83	312.00	6"	30"	309.50	24"	305.60	305.66	6"	
SOIL FILTER #2	301.50	299.16	298.32	305.00	4.5"	4.5"	302.75	15"	299.00	299.16	1.00"	

SEDIMENT BASIN OUTLET / CATCH BASIN STRUCTURE ELEVATIONS/GEOMETRY										
STRUCTURE	A	B	C	D	E	F	G	H	I	J
CB 1	310.33	304.80	312.00	311.00	2"	24"	305.30	4"	36"	309.50
CB 2	316.00	311.50	N/A	N/A	N/A	24"	312.00	N/A	N/A	N/A

**ISSUED FOR PERMITTING  
NOT FOR CONSTRUCTION  
05/29/18**

REV.	DESCRIPTION	DATE	BY	CK	APP
B	MEDEP PERMIT SET COMMENT REVISIONS	05/29/18	TJG	KRV	

OWNER ENGINEER: \_\_\_\_\_ APPROVAL STAMP: \_\_\_\_\_  
 DRAWING PREPARED BY: \_\_\_\_\_ ACCEPTED BY OE: \_\_\_\_\_

**IUSA ENGINEERING**  
 CONFIDENTIAL, PROPRIETARY and TRADE SECRET INFORMATION  
 Property of IBERDROLA, USA  
**CMP**  
 IBERDROLA - USA

**STORMWATER TREATMENT PLAN**  
 SH 2 OF 4  
 MERRILL ROAD/1076 LEWISTON, ME  
 DR: TJG SCALE: N/A FILE: 1076-003-002SH002.DWG  
 CK: KRV NO.  
 APP. DATE: 1076-003-002 REV. B

ANSI D CADD Drawing. DO NOT REVISE MANUALLY.



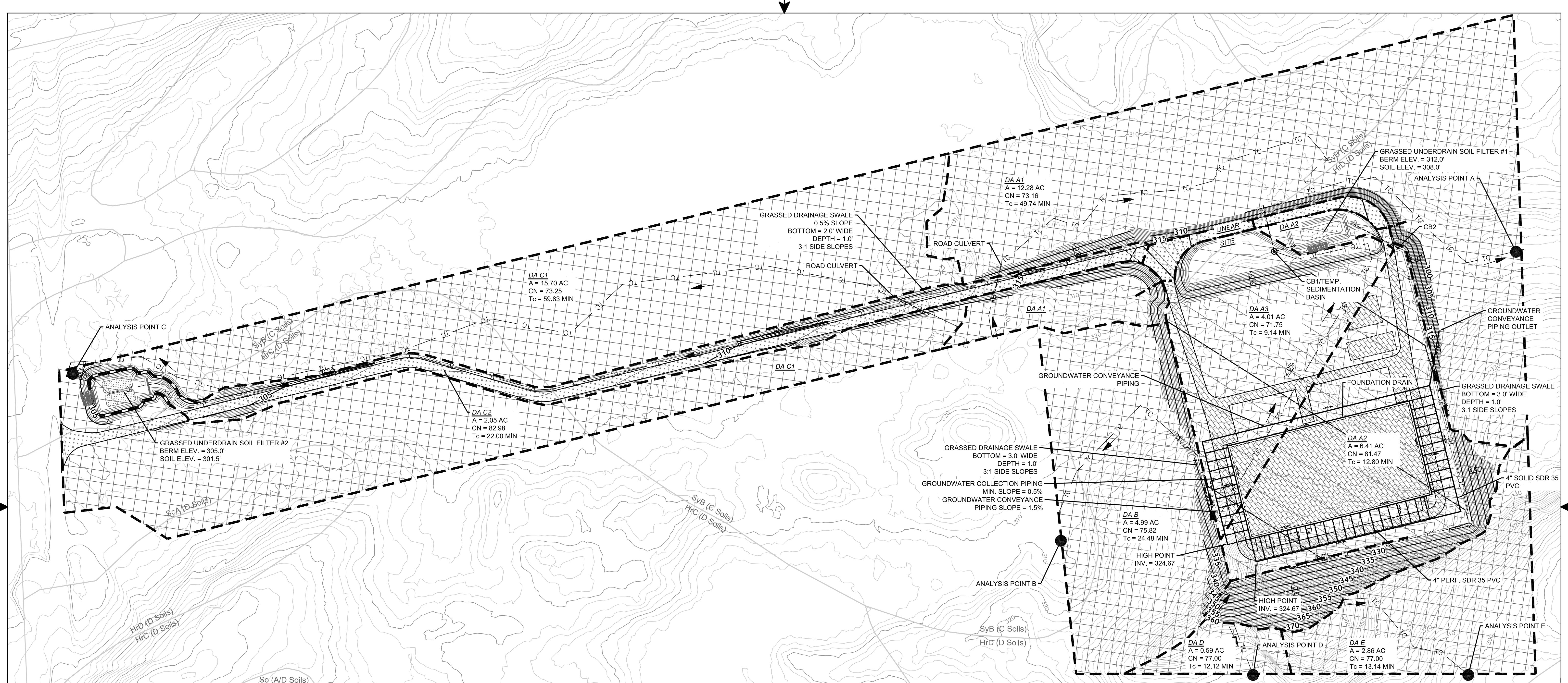

**LEGEND**

- 750 --- EX. MAJOR CONTOUR
- 744 --- EX. MINOR CONTOUR
- HrD (D Soils) EX. SOIL BOUNDARY
- HrC (C Soils) EX. OVERHEAD UTILITY
- --- EX. PROPERTY BOUNDARY
- - - - - EX. WETLAND
- [Hatched Box] EX. WOODS
- [Diagonal Lines Box] PROP. DEVELOPED GRASS
- [Dotted Box] PROP. UNDERDRAIN SOIL FILTER
- 750 --- PROP. MAJOR CONTOUR
- 744 --- PROP. MINOR CONTOUR
- TC --- PROP. TIME OF CONCENTRATION
- >--- PROP. FLOW DIRECTION ARROW
- - - - - PROP. DRAINAGE BOUNDARY
- ANALYSIS POINT
- - - - - PROP. CULVERT/PIPING
- - - - - PROP. SITE/LINEAR DEMARCATION
- [Cross-hatched Box] PROP. IMPERVIOUS PAVING/ROOF
- [Hatched Box] PROP. STONE PAD
- [Dotted Box] PROP. GRAVEL ROAD

PROPOSED CONDITIONS HYDRAULIC SUMMARY						
DRAINAGE AREA	2 - YEAR FLOW RATE (CFS)	10 - YEAR FLOW RATE (CFS)	25 - YEAR FLOW RATE (CFS)	PEAK 2 - YEAR FLOW RATE AT ANALYSIS POINT (IF SUBSHEDS PRESENT)	PEAK 10 - YEAR FLOW RATE AT ANALYSIS POINT (IF SUBSHEDS PRESENT)	PEAK 25 - YEAR FLOW RATE AT ANALYSIS POINT (IF SUBSHEDS PRESENT)
A1	5.17	12.68	16.85			
A2	7.78	15.58	19.64	11.36	23.26	31.36
A3	2.90	7.30	9.76			
B	3.50	7.98	10.41	N/A	N/A	N/A
C1	5.97	14.63	19.48	5.96	14.84	19.83
C2	2.25	4.39	5.50			
D	0.56	1.24	1.61	N/A	N/A	N/A
E	2.68	5.91	7.65	N/A	N/A	N/A

STORMWATER TREATMENT REQUIREMENTS (% OF TREATED AREA)				
LAND TYPE	STATION	STATION % TREATED	LINEAR	LINEAR % TREATED
IMPERVIOUS TOTAL	7.15 AC	99.33%	1.50 AC	75.10%
IMPERVIOUS TREATED	7.10 AC		1.13 AC	
DEVELOPED TOTAL*	10.71 AC		3.69 AC	
DEVELOPED TREATED	8.97 AC	83.75%	2.21 AC	59.89%

\*DEVELOPED AREA INCLUDES BOTH IMPERVIOUS AND LANDSCAPED SURFACES

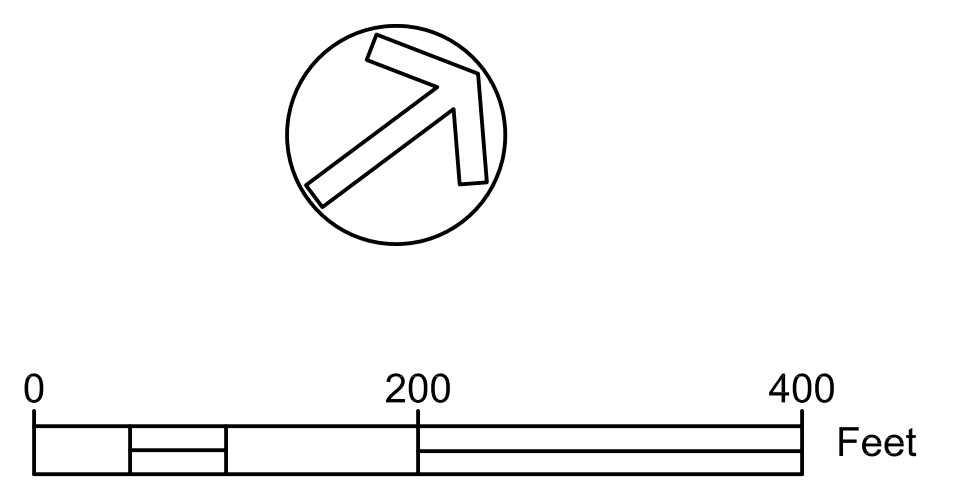

**ISSUED FOR PERMITTING  
NOT FOR CONSTRUCTION  
05/29/18**

<table border="1"> <thead> <tr> <th>REV.</th> <th>DESCRIPTION</th> <th>DATE</th> <th>BY</th> <th>CK</th> <th>APP</th> </tr> </thead> <tbody> <tr> <td>B</td> <td>MEDEP PERMIT SET COMMENT REVISIONS</td> <td>05/29/18</td> <td>TJG</td> <td>KRV</td> <td></td> </tr> </tbody> </table>	REV.	DESCRIPTION	DATE	BY	CK	APP	B	MEDEP PERMIT SET COMMENT REVISIONS	05/29/18	TJG	KRV		OWNER ENGINEER:  DRAWING PREPARED BY:	APPROVAL STAMP:  ACCEPTED BY OE:	PE Stamp	<b>IUSA ENGINEERING</b> <small>CONFIDENTIAL, PROPRIETARY and TRADE SECRET INFORMATION</small> <small>Property of Iberdrola, USA</small>		<b>POST-DEVELOPMENT STORMWATER PLAN</b>  SH 4 OF 4 <b>MERRILL ROAD/1076</b> <b>LEWISTON, ME</b>
REV.	DESCRIPTION	DATE	BY	CK	APP													
B	MEDEP PERMIT SET COMMENT REVISIONS	05/29/18	TJG	KRV														
<table border="1" style="width: 100%; border-collapse: collapse;"> <thead> <tr> <th>REV.</th> <th>DATE</th> <th>BY</th> <th>DESCRIPTION</th> <th>APP.</th> <th>DATE</th> </tr> </thead> <tbody> <tr> <td> </td> <td> </td> <td> </td> <td> </td> <td> </td> <td> </td> </tr> </tbody> </table>				REV.	DATE	BY	DESCRIPTION	APP.	DATE							SCALE: 1" = 100' FILE: 1076-003-002SH004.DWG NO. 1076-003-002 REV. B		
REV.	DATE	BY	DESCRIPTION	APP.	DATE													

ANSI D CADD Drawing DO NOT REVISE MANUALLY.



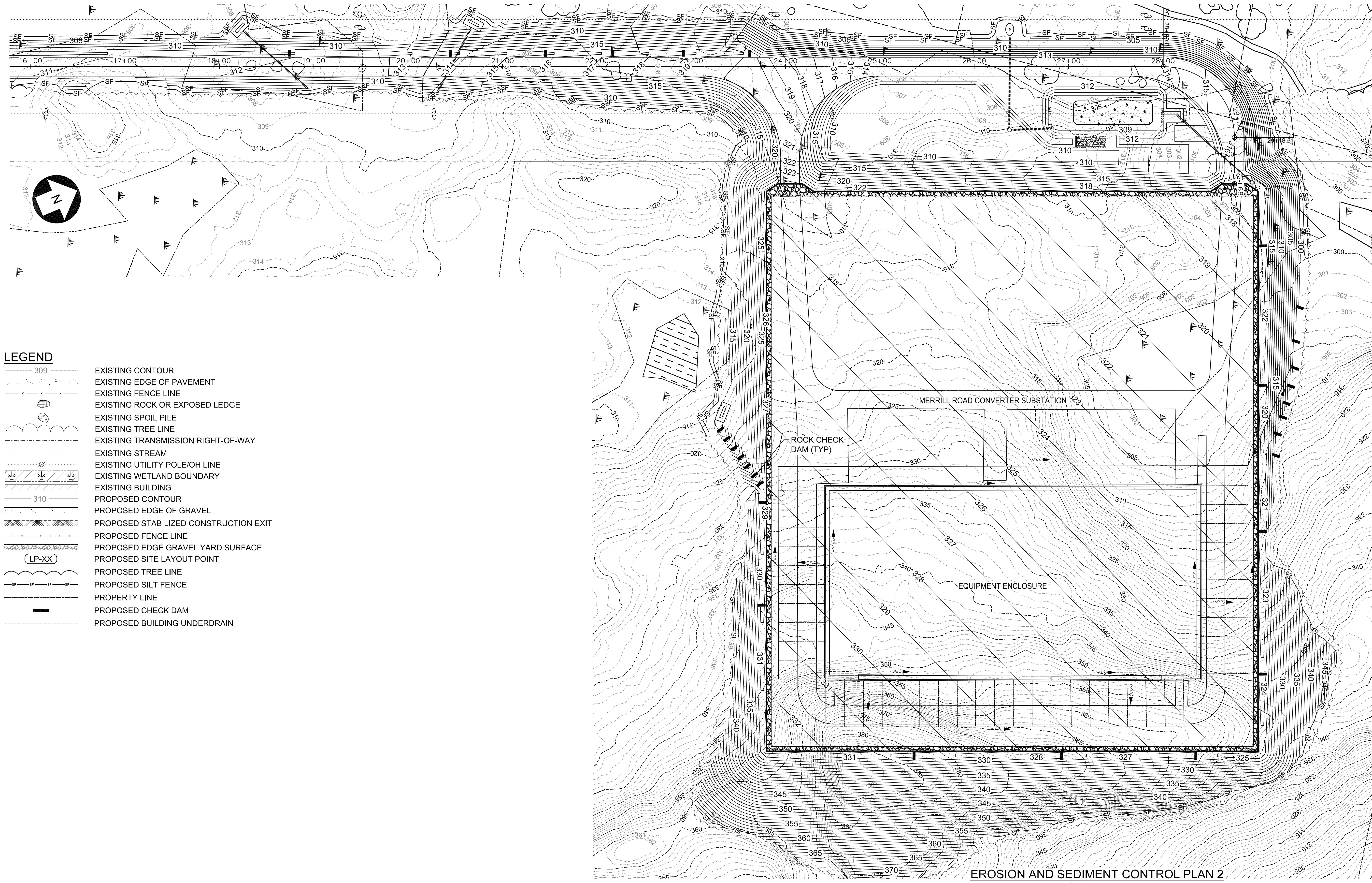

**LEGEND**

	EXISTING CONTOUR
	EXISTING EDGE OF PAVEMENT
	EXISTING FENCE LINE
	EXISTING ROCK OR EXPOSED LEDGE
	EXISTING SPOIL PILE
	EXISTING TREE LINE
	EXISTING TRANSMISSION RIGHT-OF-WAY
	EXISTING STREAM
	EXISTING UTILITY POLE/OH LINE
	EXISTING WETLAND BOUNDARY
	EXISTING BUILDING
	PROPOSED CONTOUR
	PROPOSED EDGE OF GRAVEL
	PROPOSED STABILIZED CONSTRUCTION EXIT
	PROPOSED FENCE LINE
	PROPOSED EDGE GRAVEL YARD SURFACE
	PROPOSED SITE LAYOUT POINT
	PROPOSED TREE LINE
	PROPOSED SILT FENCE
	PROPERTY LINE
	PROPOSED CHECK DAM
	PROPOSED BUILDING UNDERDRAIN

**EROSION AND SEDIMENT CONTROL PLAN 2**  
SCALE: 1"= 50'

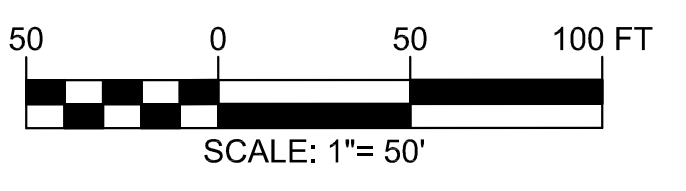

**ISSUED FOR REVIEW  
NOT FOR CONSTRUCTION  
05/29/18**

REV.	DESCRIPTION	DATE	BY	CK	APP
B	MEDEP PERMIT SET COMMENT REVISIONS	05/29/18	EVD	KRV	

OWNER ENGINEER:	APPROVAL STAMP:	PE Stamp
DRAWING PREPARED BY:	ACCEPTED BY OE:	

**USA ENGINEERING**  
CONFIDENTIAL, PROPRIETARY and TRADE SECRET INFORMATION  
Property of Iberdrola, USA

REV.	DATE	BY	DESCRIPTION	APP.	DATE:

**EROSION AND SEDIMENT CONTROL PLAN 2**  
SH 2 OF 2

MERRILL ROAD/1076 LEWISTON, ME

DR. EVD	SCALE: 1"=100'	FILE: 1076-003-003SH002.DWG
CK. KRV	NO.	
APP.		

1076-003-003 REV. B

ANSI D CADD Drawing DO NOT REVISE MANUALLY.



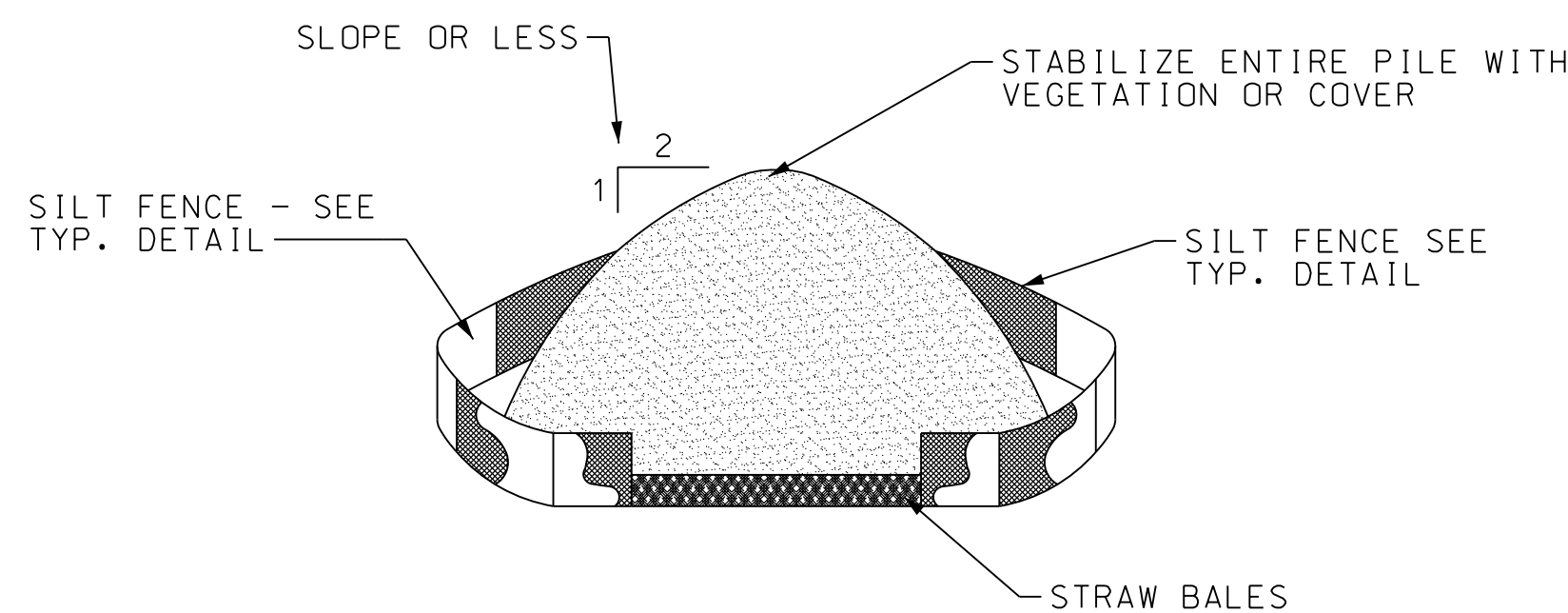
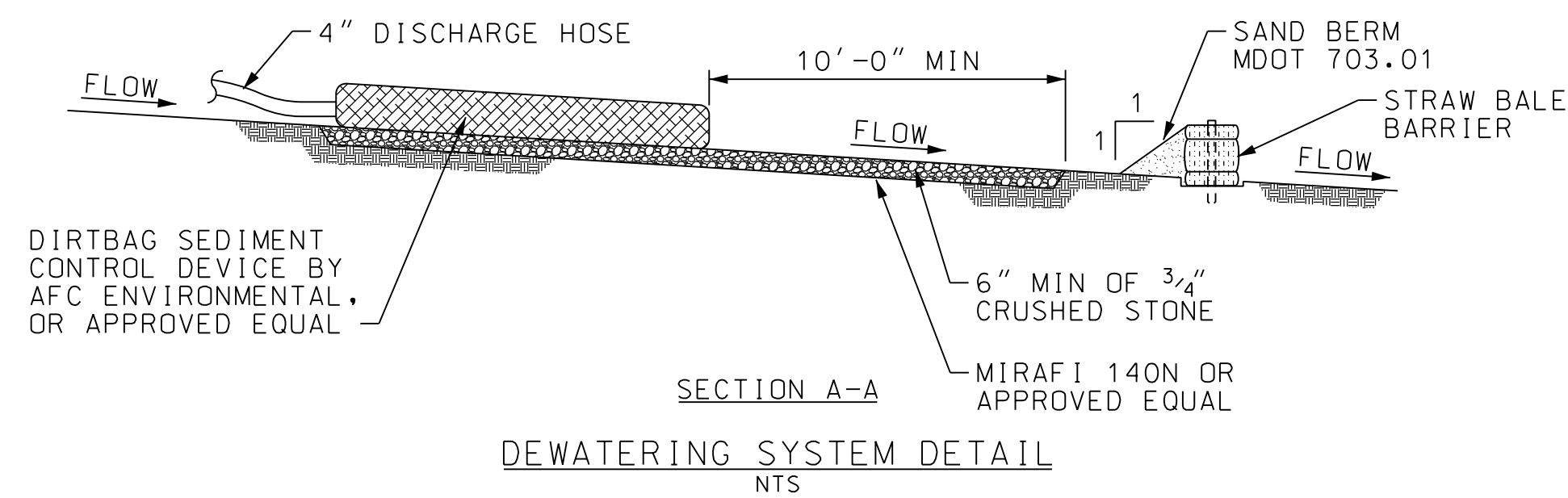
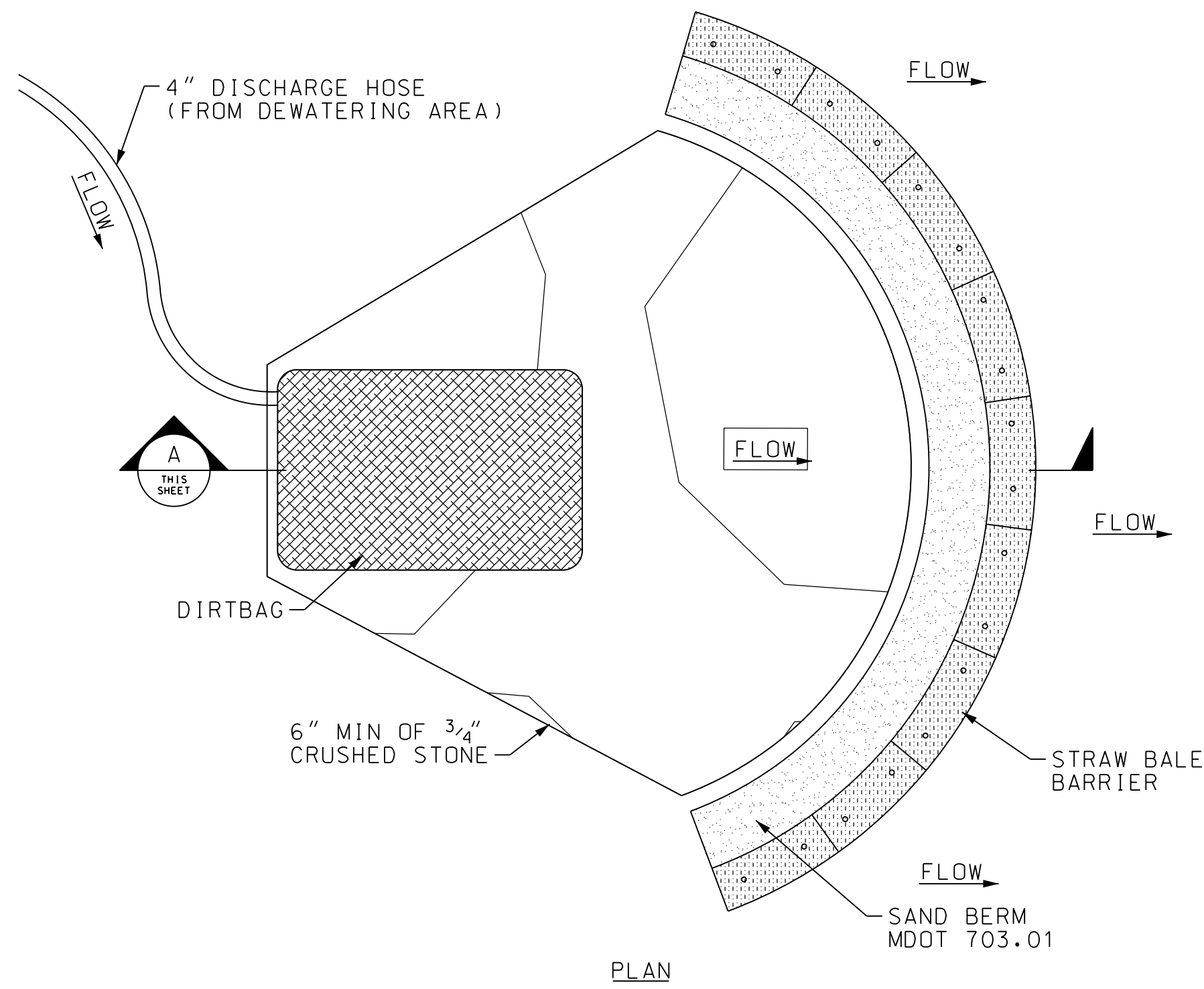

**DEWATERING NOTES:**

1. THE CONTRACTOR SHALL INSTALL, MAINTAIN, AND OPERATE ALL CHANNELS, SUMPS, AND ALL OTHER TEMPORARY DIVERSION AND PROTECTIVE WORKS NEEDED TO DIVERT STREAM FLOW AND OTHER SURFACE WATER THROUGH OR AROUND THE CONSTRUCTION SITE. CONTROL OF SURFACE WATER SHALL BE CONTINUOUS DURING THE PERIOD THAT DAMAGE TO CONSTRUCTION WORK COULD OCCUR.
2. OPEN EXCAVATIONS SHALL BE DEWATERED AND KEPT FREE OF STANDING WATER AND MUDDY CONDITIONS AS NECESSARY FOR THE PROPER EXECUTION OF THE WORK. THE CONTRACTOR SHALL FURNISH, INSTALL, OPERATE, AND MAINTAIN ALL DRAINS, SUMPS AND ALL OTHER EQUIPMENT REQUIRED TO PROPERLY DEWATER THE SITE. DEWATERING SYSTEMS THAT CAUSE A LOSS OF SOIL FINES FROM THE FOUNDATION AREAS WILL NOT BE PERMITTED.
3. INSTALL DIVERSION DITCHES OR BERMS IF NECESSARY TO MINIMIZE THE AMOUNT OF CLEAN STORMWATER RUNOFF ALLOWED INTO THE EXCAVATED AREA.
4. REMOVAL OF WATER FROM THE CONSTRUCTION SITE SHALL BE ACCOMPLISHED SO THAT EROSION AND THE TRANSPORTING OF SEDIMENT AND OTHER POLLUTANTS ARE MINIMIZED.
5. DISCHARGE DEWATERING EFFLUENT TO AREAS AS INDICATED ON THE SITE GRADING PLAN. DISCHARGE SHALL BE IN SHEET FLOW.
6. DEWATERING IN PERIODS OF INTENSE, HEAVY RAIN, WHEN THE INFILTRATIVE CAPACITY OF THE SOIL IS EXCEEDED, SHALL BE AVOIDED.
7. FLOW TO THE SEDIMENT REMOVAL STRUCTURE MAY NOT EXCEED THE STRUCTURE'S CAPACITY TO SETTLE AND FILTER FLOW OR THE STRUCTURE'S VOLUME CAPACITY.
8. WHEN TEMPORARY WORKS ARE NO LONGER NEEDED, THE CONTRACTOR SHALL REMOVE AND RETURN THE AREA TO A CONDITION SIMILAR TO THAT WHICH EXISTED BEFORE CONSTRUCTION. AREAS WHERE TEMPORARY WORKS WERE LOCATED SHALL BE GRADED FOR SIGHTLY APPEARANCE WITH NO OBSTRUCTION TO NATURAL SURFACE WATER FLOWS OR THE PROPER FUNCTIONING AND ACCESS TO THE WORKS OF IMPROVEMENT INSTALLED. THE CONTRACTOR SHALL EXERCISE EXTREME CARE DURING THE REMOVAL STAGES TO MINIMIZE THE LOSS OF SOIL SEDIMENT AND DEBRIS THAT WAS TRAPPED DURING CONSTRUCTION.

**HOUSEKEEPING PLAN:**

(MAINE DEP CHAPTER 500, APPENDIX C)

1. SPILL PREVENTION. CONTROLS MUST BE USED TO PREVENT POLLUTANTS FROM CONSTRUCTION AND WASTE MATERIALS STORED ON SITE TO ENTER STORMWATER, WHICH INCLUDES STORAGE PRACTICES TO MINIMIZE EXPOSURE OF THE MATERIALS TO STORMWATER. THE SITE CONTRACTOR OR OPERATOR MUST DEVELOP, AND IMPLEMENT AS NECESSARY, APPROPRIATE SPILL PREVENTION, CONTAINMENT, AND RESPONSE PLANNING MEASURES. ANY SPILL OR RELEASE OF TOXIC OR HAZARDOUS SUBSTANCES MUST BE REPORTED TO THE MAINE DEPARTMENT OF ENVIRONMENTAL PROTECTION (MDEP). FOR OIL SPILLS, CALL 1-800-482-0777 WHICH IS AVAILABLE 24 HOURS A DAY. FOR SPILLS OF TOXIC OR HAZARDOUS MATERIAL, CALL 1-800-452-4664 WHICH IS AVAILABLE 24 HOURS A DAY. FOR MORE INFORMATION, VISIT THE MDEP'S WEBSITE AT: <http://www.maine.gov/dep/spills/emergspillresp/>
2. GROUNDWATER PROTECTION. DURING CONSTRUCTION, LIQUID PETROLEUM PRODUCTS AND OTHER HAZARDOUS MATERIALS WITH THE POTENTIAL TO CONTAMINATE GROUNDWATER MAY NOT BE STORED OR HANDLED IN AREAS OF THE SITE DRAINING TO AN INFILTRATION AREA. AN "INFILTRATION AREA" IS ANY AREA OF THE SITE THAT BY DESIGN OR AS A RESULT OF SOILS, TOPOGRAPHY AND OTHER RELEVANT FACTORS ACCUMULATES RUNOFF THAT INFILTRATES INTO THE SOIL. DIKES, BERMS, SUMPS, AND OTHER FORMS OF SECONDARY CONTAINMENT THAT PREVENT DISCHARGE TO GROUNDWATER MAY BE USED TO ISOLATE PORTIONS OF THE SITE FOR THE PURPOSES OF STORAGE AND HANDLING OF THESE MATERIALS. ANY PROJECT PROPOSING INFILTRATION OF STORMWATER MUST PROVIDE ADEQUATE PRE-TREATMENT OF STORMWATER PRIOR TO DISCHARGE OF STORMWATER TO THE INFILTRATION AREA, OR PROVIDE FOR TREATMENT WITHIN THE INFILTRATION AREA, IN ORDER TO PREVENT THE ACCUMULATION OF FINES, REDUCTION IN INFILTRATION RATE, AND CONSEQUENT FLOODING AND DESTABILIZATION.  
  
LACK OF APPROPRIATE POLLUTANT REMOVAL BEST MANAGEMENT PRACTICES (BMPs) MAY RESULT IN VIOLATIONS OF THE GROUNDWATER QUALITY STANDARD ESTABLISHED BY 38 M.R.S.A. SECTION 465-C(1).
3. FUGITIVE SEDIMENT AND DUST. ACTIONS MUST BE TAKEN TO ENSURE THAT ACTIVITIES DO NOT RESULT IN NOTICEABLE EROSION OF SOILS OR FUGITIVE DUST EMISSIONS DURING OR AFTER CONSTRUCTION. OIL MAY NOT BE USED FOR DUST CONTROL, BUT OTHER WATER ADDITIVES MAY BE CONSIDERED AS NEEDED. A STABILIZED CONSTRUCTION ENTRANCE (SCE) SHOULD BE INCLUDED TO MINIMIZE TRACKING OF MUD AND SEDIMENT. IF OFF-SITE TRACKING OCCURS, PUBLIC ROADS SHOULD BE SWEEPED IMMEDIATELY AND NO LESS THAN ONCE A WEEK AND PRIOR TO SIGNIFICANT STORM EVENTS. OPERATIONS DURING DRY MONTHS, THAT EXPERIENCE FUGITIVE DUST PROBLEMS, SHOULD WET DOWN UNPAVED ACCESS ROADS ONCE A WEEK OR MORE FREQUENTLY AS NEEDED WITH A WATER ADDITIVE TO SUPPRESS FUGITIVE SEDIMENT AND DUST.

DEWATERING A STREAM WITHOUT A PERMIT FROM THE MDEP MAY VIOLATE STATE WATER QUALITY STANDARDS AND THE NATURAL RESOURCES PROTECTION ACT.

**HOUSEKEEPING PLAN (CONT):**

4. DEBRIS AND OTHER MATERIALS. MINIMIZE THE EXPOSURE OF CONSTRUCTION DEBRIS, BUILDING AND LANDSCAPING MATERIALS, TRASH, FERTILIZERS, PESTICIDES, HERBICIDES, DETERGENTS, SANITARY WASTE AND OTHER MATERIALS TO PRECIPITATION AND STORMWATER RUNOFF. THESE MATERIALS MUST BE PREVENTED FROM BECOMING A POLLUTANT SOURCE.  
  
TO PREVENT THESE MATERIALS FROM BECOMING A SOURCE OF POLLUTANTS, CONSTRUCTION AND POST-CONSTRUCTION ACTIVITIES RELATED TO A PROJECT MAY BE REQUIRED TO COMPLY WITH APPLICABLE PROVISIONS OF RULES RELATED TO SOLID, UNIVERSAL, AND HAZARDOUS WASTE, INCLUDING, BUT NOT LIMITED TO, THE MAINE SOLID WASTE AND HAZARDOUS WASTE MANAGEMENT RULES; MAINE HAZARDOUS WASTE MANAGEMENT RULES; MAINE OIL CONVEYANCE AND STORAGE RULES; AND MAINE PESTICIDE REQUIREMENTS.
5. EXCAVATION DE-WATERING. EXCAVATION DE-WATERING IS THE REMOVAL OF WATER FROM TRENCHES, FOUNDATIONS, COFFER DAMS, PONDS, AND OTHER AREAS WITHIN THE CONSTRUCTION AREA THAT RETAIN WATER AFTER EXCAVATION. IN MOST CASES THE COLLECTED WATER IS HEAVILY SILTED AND HINDERS CORRECT AND SAFE CONSTRUCTION PRACTICES. THE COLLECTED WATER REMOVED FROM THE PONDED AREA, EITHER THROUGH GRAVITY OR PUMPING, MUST BE SPREAD THROUGH NATURAL WOODED BUFFERS OR REMOVED TO AREAS THAT ARE SPECIFICALLY DESIGNED TO COLLECT THE MAXIMUM AMOUNT OF SEDIMENT POSSIBLE, LIKE A COFFERDAM SEDIMENTATION BASIN. AVOID ALLOWING THE WATER TO FLOW OVER DISTURBED AREAS OF THE SITE. EQUIVALENT MEASURES MAY BE TAKEN IF APPROVED BY THE MDEP.
6. AUTHORIZED NON-STORMWATER DISCHARGES. IDENTIFY AND PREVENT CONTAMINATION BY NON-STORMWATER DISCHARGES. WHERE ALLOWED NON-STORMWATER DISCHARGES EXIST, THEY MUST BE IDENTIFIED AND STEPS SHOULD BE TAKEN TO ENSURE THE IMPLEMENTATION OF APPROPRIATE POLLUTION PREVENTION MEASURES FOR THE NON-STORMWATER COMPONENT(S) OF THE DISCHARGE. AUTHORIZED NON-STORMWATER DISCHARGES ARE:  
 (A) DISCHARGES FROM FIREFIGHTING ACTIVITY;  
 (B) FIRE HYDRANT FLUSHINGS;  
 (C) VEHICLE WASHWATER IF DETERGENTS ARE NOT USED AND WASHING IS LIMITED TO THE EXTERIOR OF VEHICLES (ENGINE, UNDERCARRIAGE AND TRANSMISSION WASHING IS PROHIBITED);  
 (D) DUST CONTROL RUNOFF IN ACCORDANCE WITH PERMIT CONDITIONS AND PARAGRAPH 3 ABOVE;  
 (E) ROUTINE EXTERNAL BUILDING WASHDOWN, NOT INCLUDING SURFACE PAINT REMOVAL, THAT DOES NOT INVOLVE DETERGENTS;  
 (F) PAVEMENT WASHWATER (WHERE SPILLS/LEAKS OF TOXIC OR HAZARDOUS MATERIALS HAVE NOT OCCURRED, UNLESS ALL SPILLED MATERIAL HAS BEEN REMOVED) IF DETERGENTS ARE NOT USED;  
 (G) UNCONTAMINATED AIR CONDITIONING OR COMPRESSOR CONDENSATE;  
 (H) UNCONTAMINATED GROUNDWATER OR SPRING WATER;  
 (I) FOUNDATION OR FOOTER DRAIN-WATER WHERE FLOWS ARE NOT CONTAMINATED;  
 (J) UNCONTAMINATED EXCAVATION DEWATERING (SEE REQUIREMENTS IN PARAGRAPH 5 ABOVE);  
 (K) POTABLE WATER SOURCES INCLUDING WATERLINE FLUSHINGS; AND LANDSCAPE IRRIGATION.
7. UNAUTHORIZED NON-STORMWATER DISCHARGES. THE MDEP'S APPROVAL UNDER THIS CHAPTER DOES NOT AUTHORIZE A DISCHARGE THAT IS MIXED WITH A SOURCE OF NONSTORMWATER, OTHER THAN THOSE DISCHARGES IN COMPLIANCE WITH PARAGRAPH 6 ABOVE. SPECIFICALLY, THE MDEP'S APPROVAL DOES NOT AUTHORIZE DISCHARGES OF THE FOLLOWING:  
 (A) WASTEWATER FROM THE WASHOUT OR CLEANOUT OF CONCRETE, STUCCO, PAINT, FORM RELEASE OILS, CURING COMPOUNDS OR OTHER CONSTRUCTION MATERIALS;  
 (B) FUELS, OILS OR OTHER POLLUTANTS USED IN VEHICLE AND EQUIPMENT OPERATION AND MAINTENANCE;  
 (C) SOAPS, SOLVENTS, OR DETERGENTS USED IN VEHICLE AND EQUIPMENT WASHING; AND  
 (D) TOXIC OR HAZARDOUS SUBSTANCES FROM A SPILL OR OTHER RELEASE.

**INSTALLATION NOTES:**

1. AREA CHOSEN FOR STOCKPILING OPERATIONS SHALL BE DRY AND STABLE.
2. MAXIMUM SLOPE OF STOCKPILE SHALL BE 2H:1V.
3. UPON COMPLETION OF SOIL STOCKPILING, EACH PILE SHALL BE SURROUNDED WITH EITHER SILT FENCING OR STRAW BALES, THEN STABILIZED WITH VEGETATION OR COVERED.

**ISSUED FOR REVIEW  
NOT FOR CONSTRUCTION  
05/29/18**

REV.	DESCRIPTION	DATE	BY	CK	APP
B	MEDEP PERMIT SET COMMENT REVISIONS	05/29/18	EVD	KRV	

OWNER ENGINEER:	APPROVAL STAMP:
DRAWING PREPARED BY:	ACCEPTED BY OE:

PE Stamp
----------

<b>USA ENGINEERING</b> CONFIDENTIAL, PROPRIETARY and TRADE SECRET INFORMATION <small>Property of Iberdrola, USA</small>		 <b>CMP</b> IBERDROLA - USA			
REV.	DATE	BY	DESCRIPTION	APP.	DATE:

<b>SITE DETAILS</b> SH 5 OF 6 <b>MERRILL ROAD/1076</b> LEWISTON, ME		
DR. EVD	SCALE: NONE	FILE: 1076-003-005SH006.DWG
CK. KRV	NO.	
APP.		
<b>1076-003-005</b>		REV. B

ANSI D15.1 CADD Drawing. DO NOT REVISE MANUALLY.

**CONSTRUCTION SEQUENCE:**

- ESTABLISH CONSTRUCTION WORKSPACE LIMITS; IDENTIFY AND MARK SENSITIVE RESOURCES.
- PERFORM ALL WORK IN ACCORDANCE WITH MAINE EROSION AND SEDIMENT CONTROL PRACTICES FIELD GUIDE FOR CONTRACTORS (2015).
- PRIOR TO USAGE, CONSTRUCT AND STABILIZE THE CONSTRUCTION ENTRANCE ON THE EXISTING PERMANENT ACCESS ROAD WITH A STONE PAD, MUD RACK, OR OTHER MATERIALS USED TO REDUCE THE TRACKING OR FLOWING OF SEDIMENT OFF THE SITE AND MAINTAIN UNTIL PAVING IS COMPLETED.
- CLEAR TIMBER AND BRUSH; DO NOT GRUB UNTIL JUST PRIOR TO PRELIMINARY GRADING AND ESTABLISHMENT AND STABILIZATION OF TEMPORARY OR PERMANENT DRAINAGE COURSES.
- INSTALL AND MAINTAIN SEDIMENT BARRIERS SUCH AS SILT FENCING AND/OR OTHER EROSION CONTROL BARRIERS ALONG THE DOWNHILL LIMIT OF WORK, AS SHOWN ON THE DRAWINGS. SEDIMENT BARRIER LOCATIONS MAY BE ADJUSTED IN THE FIELD BASED ON SITE CONDITIONS AS DETERMINED BY THE ENGINEERING INSPECTOR. WHERE SILT FENCE CANNOT BE TOED-IN PROPERLY DUE TO TREE ROOTS, ROCKS OR FROZEN GROUND, HAY BALES OR AN EROSION CONTROL MIX BERM MAY BE SUBSTITUTED. SILT FENCING WILL BE INSTALLED AFTER CLEARING BUT PRIOR TO GRUBBING AND GRADING ACTIVITIES. ANY EROSION ISSUES DEVELOPED DURING CLEARING WILL BE TEMPORARILY STABILIZED AS NECESSARY.
- INSTALL THE SEDIMENT BASIN CONTROL STRUCTURE AND OUTLET PIPING AND GRADE THE SEDIMENT BASIN AND SURROUNDING AREA TO PROPOSED PLAN GRADES UP TO ELEVATION 312' SUCH THAT RUNOFF FROM UPSTREAM DISTURBANCES MAY FLOW INTO THE BASIN.
- STABILIZE PERMANENT ACCESS ROAD SURFACE, PARKING AREAS AND EQUIPMENT STORAGE AND LAYDOWN AREAS WITH MATTING, CRUSHED STONE OR GRAVEL SUBBASE AS NECESSARY TO MINIMIZE RUTTING AND AVOID PONDING.
- CONCURRENT WITH INITIATION OF SITE GRADING, CONSTRUCT AND STABILIZE TEMPORARY DRAINAGE SWALES, DIVERSION BERMS, CHECK DAMS, AND CULVERTS WITH TEMPORARY INLET AND OUTLET STRUCTURES TO MINIMIZE SEDIMENT IN SITE RUNOFF DURING THE CONSTRUCTION OF THE ROADWAY. DEWATER IN ACCORDANCE WITH DEWATERING NOTES BELOW.
- INSTALL PROPERLY SPACED STONE CHECK DAMS IN ANY SECTION OF DITCH WITHIN 24 HOURS OF FORMING, SHAPING OR ROUGH GRADING THAT SECTION OF DITCH.
- MINIMIZE THE AMOUNT OF DISTURBANCE AT ANY ONE TIME BY STAGING CONSTRUCTION AS MUCH AS PRACTICAL FOR EFFICIENT CONSTRUCTION OF THE FACILITY. NATURAL VEGETATIVE BUFFERS OR STRIPS SHOULD BE LEFT IN PLACE WHERE FEASIBLE TO AID IN SEDIMENT RETENTION AND REDUCE EROSION POTENTIAL.
- STABILIZE ANY NEWLY GRADED SLOPE GREATER THAN EIGHT PERCENT AND ANY SECTION OF NEWLY CONSTRUCTED DITCH USING ANCHORED EROSION CONTROL BLANKETS OR OTHER APPROVED MULCHING TECHNIQUES WITHIN 24 HOURS. STABILIZE ANY SLOPE EXCEEDING EIGHT PERCENT AND BROUGHT TO FINAL GRADE WITHIN 24 HOURS USING ANCHORED EROSION CONTROL BLANKETS OR EROSION CONTROL MIX APPLIED IN ACCORDANCE WITH MAINE EROSION AND SEDIMENT PRACTICES FIELD GUIDE FOR CONTRACTORS (2015). STABILIZE ANY SECTION OF DITCH BROUGHT TO FINAL GRADE WITHIN 24 HOURS USING THE APPROVED PERMANENT STABILIZATION MEASURES FOR DITCHES.
- DUST CONTROL METHODS WILL BE EMPLOYED AFTER GRADING AND PRIOR TO FINAL STABILIZATION TO PREVENT THE BLOWING AND MOVEMENT OF DUST THROUGH THE APPLICATION OF WATER AND/OR CALCIUM CHLORIDE TO REDUCE WIND EROSION. REPETITIVE TREATMENT WILL BE APPLIED AS NEEDED TO ACCOMPLISH CONTROL.
- APPLY TEMPORARY SEED AND MULCH TO ANY EXPOSED AREAS WHERE ACTIVITY IS NOT ANTICIPATED FOR 30 DAYS OR MORE, OR WHERE ACTIVITY HAS NOT OCCURRED WITHIN 30 DAYS. TEMPORARILY MULCH ANY EXPOSED AREAS WHERE ACTIVITY IS NOT ANTICIPATED OR HAS NOT OCCURRED IN 7 DAYS.
- REMOVE EXCESS SPOILS FROM SITE THAT WILL NOT BE USED FOR THE FINAL DESIGN AND STABILIZATION. STOCKPILED SOILS THAT REMAIN IN PLACE FOR 48 HOURS OR MORE WILL BE CONTAINED WITH SEDIMENT BARRIERS SUCH AS SILT FENCE, HAY BALES OR EQUIVALENT. THE SEDIMENT BARRIERS SHALL BE ADEQUATELY LOCATED AND REINFORCED TO HANDLE A SIGNIFICANT RAIN EVENT AND THE POTENTIAL SLUMPING OF THE PILE. BETWEEN MAY 1 AND OCTOBER 15, APPLY TEMPORARY SEED AND MULCH TO A STOCKPILE THAT IS NOT EXPECTED TO BE DISTURBED WITHIN 30 DAYS. APPLY ANCHORED MULCH DAILY, AS NEEDED, DURING WINTER CONSTRUCTION.
- INSPECT AND REPAIR EROSION CONTROL MEASURES DAILY IN AREAS OF ACTIVE CONSTRUCTION; OTHERWISE WEEKLY AND AFTER RAINFALL OF 1/2" OR GREATER WITHIN A 24-HOUR PERIOD. REMOVE ACCUMULATED SEDIMENT WHEN IT REACHES 1/3 THE HEIGHT OF THE BARRIER.
- MONITOR PUBLIC ROADS FOR SIGNS OF TRACKING OR SPILLING OF SPOIL MATERIAL AND CLEAN UP AS NEEDED.
- COMPLETE FINAL GRADING AND STABILIZATION OF EARTHEN STRUCTURES SUCH AS DIVERSION BERMS, DITCH TURNOUTS AND SWALES THAT WILL CONTROL RUNOFF. LOWER THE TEMPORARY SEDIMENT BASIN INLET GRATE TOP TO THE FINAL PROPOSED PLAN ELEVATION.
- FINISH GRADE AND REPLACE TOPSOIL OR LOAM IN DISTURBED AREAS. SEED AND MULCH DISTURBED AREAS WITHIN 6 DAYS OF FINAL GRADING.
- MAINTAIN ALL TEMPORARY EROSION CONTROLS AND SEDIMENT BARRIERS UNTIL VEGETATION HAS BEEN ESTABLISHED OVER 85-90% OF THE AREA TO BE RE-VEGETATED. RESEED SPARSELY VEGETATED AREAS.
- REMOVE ALL TEMPORARY EROSION AND SEDIMENTATION CONTROL MEASURES ONCE THE SITE IS PERMANENTLY STABILIZED.

**FERTILIZER AND LIMESTONE REQUIREMENTS:**

THE FERTILIZER AND LIME APPLICATION RATES SHALL BE DETERMINED USING THE SITE-SPECIFIC SOIL TEST RESULTS.

**MULCH AND SEEDING SPECIFICATIONS**

SUMMARY OF TEMPORARY AND PERMANENT MULCH APPLICATION REQUIREMENTS			
CONDITION	TIMING	MULCH TYPE <sup>1,2</sup>	APPLICATION RATES
<b>TEMPORARY</b>			
	IF NO ACTIVITY IN EXPOSED AREAS FOR 7 DAYS, OR PRIOR TO A STORM EVENT	STRAW MULCH OR WOOD FIBER MULCH	2 TONS/ACRES 2000 LB./ACRES
ALL DISTRIBUTED AREAS OF THE CONSTRUCTION WORKSPACE	APPLY MULCH TO ALL EXPOSED AREAS IF NO ACTIVITY OCCURS WITHIN 30 DAYS. APPLY MULCH AND TEMPORARY SEEDING SOONER WHEN IT CAN BE ANTICIPATED THAT ACTIVITY IS NOT GOING TO OCCUR WITHIN 30 DAYS.	STRAW MULCH OR WOOD FIBER MULCH	2 TONS/ACRES 2000 LB./ACRES <sup>3</sup>
ALL WORK AREAS EXPOSED ARE TO BE MULCHED DAILY EACH TIME SOIL IS DISTURBED	OCTOBER 15 - MAY 1	STRAW MULCH OR WOOD FIBER MULCH	3 TONS/ACRES 2000 LB./ACRES
<b>PERMANENT</b>			
ON ALL EXPOSED AREAS AFTER SEEDING TO STABILIZE THE SOIL SURFACE	PERMANENT GRASS AND/OR LEGUME SEEDING COVERED BY HAY OR STRAW MULCH ON ALL AREAS THAT HAVE BEEN RESTORED TO FINAL GRADE. THIS DOES NOT APPLY TO AREAS STABILIZED BY OTHER MEANS SUCH AS JUTE MATTING OR PERMANENT EROSION CONTROL MIX.	CRIMPED STRAW MULCH OR PAPER MULCH OR WOOD FIBER MULCH	2 TONS/ACRES 1500 LB./ACRES <sup>4</sup> 2000 LB./ACRES
WOOD CHIP APPLICATION AREAS	PERMANENT GRASS AND/OR LEGUME SEEDING COVERED BY HAY OR STRAW MULCH ON ALL AREAS THAT HAVE BEEN RESTORED TO FINAL GRADE. THIS DOES NOT APPLY TO AREAS STABILIZED BY OTHER MEANS SUCH AS JUTE MATTING OR PERMANENT EROSION CONTROL MIX.	CRIMPED STRAW MULCH OR PAPER MULCH OR WOOD FIBER MULCH	2 TONS/ACRES 1500 LB./ACRES <sup>4</sup> 2000 LB./ACRES
<b>NOTES:</b> 1. STRAW AND HAY MULCH MAY BE USED INTERCHANGEABLY, EXCEPT IN WETLAND AREAS WHERE STRAW MULCH WILL BE REQUIRED. 2. DOUBLE RATE OF WOOD FIBER MULCH WHEN USED IN CRITICAL AREAS. 3. STRAW, HAY, OR HYDROMULCH (WOOD FIBER OR PAPER MULCH AS APPROPRIATE) WILL PROVIDE 90 PERCENT GROUND COVERAGE 4. PAPER MULCH IS ACCEPTABLE FOR USE DURING THE GROWING SEASON. ON SLOPES GREATER THAN 30 PERCENT AND IN AREAS WHERE VEGETATION HAS NOT ESTABLISHED WELL, ADDITIONAL HAY MULCH WILL BE ADDED AS A WINTERIZING MEASURE.			



**MULCH ANCHORING REQUIREMENTS**

ON SLOPES GREATER THAN 3 PER CENT, HAY OR STRAW MULCH WILL BE FIRMLY ANCHORED INTO THE SOIL UTILIZING ONE OF THE FOLLOWING METHODS:  
 -CRIMPING WITH A STRAIGHT OR NOTCHED MULCH CRIMPING TOOL (FARM DISCS WILL NOT BE ALLOWED);  
 -TRACK WALKING WITH DEEP-CLEATED EQUIPMENT OPERATING UP AND DOWN THE SLOPE (MULCH CRIMPED PERPENDICULAR TO THE SLOPE) ON SLOPES LESS THAN 25 PERCENT;  
 -APPLICATION OF MULCH NETTING;  
 -APPLICATION OF 500 LB./ACRE OF WOOD FIBER MULCH OVER STRAW/HAY MULCH; AND  
 -COMMERCIALY AVAILABLE TACKIFIERS (EXCEPT WITHIN 100 FEET OF WATERBODIES OR WETLANDS).

SUMMARY OF SEEDING REQUIREMENTS		
CONDITION	TIMING <sup>1,2</sup>	SEED MIX
TEMPORARY SEEDING <sup>3</sup>	TEMPORARY SEED BETWEEN MAY 1 AND OCTOBER 15 ONLY. DISTURBED AREAS OR SPOIL STOCKPILES WILL BE SEEDED IMMEDIATELY IF FURTHER DISTURBANCE IS NOT EXPECTED FOR 30 DAYS OR MORE.	ANNUAL RYEGRASS
<b>PERMANENT SEEDING<sup>3,4</sup></b>		
UPLAND PORTIONS OF THE CONSTRUCTION AREA	DISTURBED AREA WILL BE SEEDED WITHIN 6 DAYS OF FINAL GRADING.	PERMANENT UPLAND MIX
SLOPES GREATER THAN 3:1	DISTURBED AREA WILL BE SEEDED IMMEDIATELY AFTER SEEDBED PREPARATION.	PERMANENT UPLAND MIX
WETLANDS	DISTURBED WETLANDS WILL BE SEEDED WITHIN 6 DAYS OF FINAL GRADING.	ANNUAL RYEGRASS
WOOD CHIP APPLICATION AREAS	DISTURBED AREA WILL BE SEEDED WITHIN 6 DAYS OF FINAL GRADING.	WOODCHIP APPLICATION SEED MIX
WINTER DORMANT SEEDING	DORMANT SEED BETWEEN OCTOBER 15 AND MAY 1 ONLY. NO SEEDING WILL OCCUR IF SNOW DEPTHS EXCEED 1 INCH.	PERMANENT UPLAND MIX PLUS WINTER RYEGRASS
<b>NOTES:</b> 1. WEATHER CONDITIONS PERMITTING. 2. AREAS THAT DO NOT SUCCESSFULLY REVEGETATE WITHIN APPROPRIATE PERIOD OF TIME WILL BE RESEDED AS NECESSARY. 3. LOOSEN COMPACTED SOIL TO A MINIMUM DEPTH OF 4 INCHES. 4. TOP DRESS WITH 6 INCHES LOAM, AS NEEDED.		

SEED MIX SPECIFICATIONS		
SEED MIX NAME	SEED MIX COMPONENTS	LB./ACRE <sup>1</sup>
TEMPORARY SEED MIX	ANNUAL RYEGRASS	40
PERMANENT UPLAND SEED MIX	REDTOP CREEPING RED FESCUE TALL FESCUE BIRDSFOOT TREFLOIL	4 40 40 16
WOOD CHIP APPLICATION SEED MIX	CREEPING RED FESCUE REDTOP TALL FESCUE CROWNVETCH	20 4 30 30
WETLAND SEED MIX	ANNUAL RYEGRASS	40
SUPPLEMENTAL WINTER SEED MIX <sup>2</sup>	WINTER RYEGRASS	120
<b>NOTES:</b> 1. INCREASE SEEDING RATES 10% WHEN HYDROSEEDING 2. WINTER RYE WILL BE ADDED TO PERMANENT UPLAND MIX AT A RATE OF 120 LB./ACRE BETWEEN OCTOBER 15 AND MAY 1		

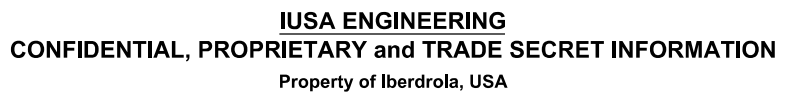
**ISSUED FOR REVIEW  
NOT FOR CONSTRUCTION  
05/29/18**

<table border="1" style="width: 100%; border-collapse: collapse;"> <thead> <tr> <th>REV.</th> <th>DESCRIPTION</th> <th>DATE</th> <th>BY</th> <th>CK</th> <th>APP</th> </tr> </thead> <tbody> <tr> <td>B</td> <td>MDEP PERMIT SET COMMENT REVISIONS</td> <td>05/29/18</td> <td>EVD</td> <td>KRV</td> <td></td> </tr> </tbody> </table>	REV.	DESCRIPTION	DATE	BY	CK	APP	B	MDEP PERMIT SET COMMENT REVISIONS	05/29/18	EVD	KRV		OWNER ENGINEER:  APPROVAL STAMP:  PE Stamp	DRAWING PREPARED BY:  ACCEPTED BY OE:	<div style="text-align: center;">   <b>CONFIDENTIAL, PROPRIETARY and TRADE SECRET INFORMATION</b>                      Property of Iberdrola, USA                 </div>	<div style="text-align: center;">  </div>	<p style="text-align: center;"><b>SITE DETAILS</b></p> <p style="text-align: center;">SH 6 OF 6</p> <p style="text-align: center;"><b>MERRILL ROAD/1076 LEWISTON, ME</b></p> <table border="1" style="width: 100%; border-collapse: collapse;"> <tr> <td>DR. EVD</td> <td>SCALE: NONE</td> <td>FILE: 1076-003-005SH06.DWG</td> </tr> <tr> <td>CK. KRV</td> <td>NO.</td> <td></td> </tr> <tr> <td>APP.</td> <td></td> <td></td> </tr> </table> <p style="text-align: right;">1076-003-005 B</p>	DR. EVD	SCALE: NONE	FILE: 1076-003-005SH06.DWG	CK. KRV	NO.		APP.		
REV.	DESCRIPTION	DATE	BY	CK	APP																					
B	MDEP PERMIT SET COMMENT REVISIONS	05/29/18	EVD	KRV																						
DR. EVD	SCALE: NONE	FILE: 1076-003-005SH06.DWG																								
CK. KRV	NO.																									
APP.																										
<table border="1" style="width: 100%; border-collapse: collapse;"> <thead> <tr> <th>REV.</th> <th>DATE</th> <th>BY</th> <th>DESCRIPTION</th> <th>APP.</th> <th>DATE:</th> </tr> </thead> <tbody> <tr> <td> </td> <td> </td> <td> </td> <td> </td> <td> </td> <td> </td> </tr> </tbody> </table>						REV.	DATE	BY	DESCRIPTION	APP.	DATE:															
REV.	DATE	BY	DESCRIPTION	APP.	DATE:																					

ANSI D15 CAD Drawing DO NOT REVISE MANUALLY